

can-am®

OFF-ROAD



Side-by-Side & ATV Product Spec Book

2023

Vehicle Specifications, Accessories, and Parts & Maintenance

TABLE OF CONTENTS

CAN-AM DEFENDER

Model Packages	6
Comparative Chart	18
Accessories	21

CAN-AM MAVERICK X3

Model Packages	70
Comparative Chart	76
Accessories	77

CAN-AM COMMANDER

Model Packages	116
Comparative Chart	120
Accessories	121

CAN-AM ATVs

Model Packages	168
Comparative Chart	176
Accessories	177

PARTS AND MAINTENANCE

Genuine Parts	223
Lubricant & Oil Change Kit	228
Maintenance Products	229
Care Products	231

CAN-AMOFFROAD.COM

© 2023 Bombardier Recreational Products Inc. (BRP). All rights reserved. ®, TM and the BRP logo are trademarks of BRP or its affiliates. †All other trademarks are the property of their respective owners. BRP reserves the right to discontinue or change specifications, prices, designs, features, models or equipment without incurring obligation. Some models depicted may include optional equipment. Product performance may vary depending on weather, temperature, altitude, driving ability and driver/passenger weight. Prices, if shown, are based on the manufacturer's suggested retail price. Dealers may sell at a different price. BRP recommends that all ATV-SSV drivers take a training course. See your dealer or call the ATV Safety Institute at 1-800-887-2887 (USA) or the Canadian Safety Council at 1-613-739-1535 (Canada). ATVs and SSVs can be hazardous to operate. Never carry passengers on any ATV-SSV not specifically designed by the manufacturer for such use. All adult-model Can-Am ATVs are category G ATVs (general-use models) intended for recreational and/or utility use by an operator age 16 or older. Carefully read the vehicle's operator's guide. Follow all instructional and safety material and observe applicable laws and regulations. ATVs and SSVs are for off-road use only; never ride on paved surfaces or public roads. For your safety, the operator and passenger(s) must wear a helmet, eye protection and applicable protective clothing. Always remember that riding, alcohol and drugs don't mix. Never engage in stunt driving. Avoid excessive speed and be particularly careful on difficult terrain. Always ride responsibly and safely. See your authorized BRP dealer for details and visit can-am.brp.com.





BRP 12 MONTH LIMITED WARRANTY ON GENUINE PARTS & ACCESSORIES*

For new Can-Am accessories & genuine parts products sold through BRP & our authorized dealer network.

*The limited warranty is subject to the exclusions, limitations of liabilities and all other terms and conditions of BRP's standard limited warranty. See the complete limited warranty applicable to your product, or contact your authorized Can-Am Off-Road dealer. Applicable only to BRP products purchased at authorized BRP dealers or distributors. This limited warranty may not apply to factory-installed parts and accessories. Always refer to the product-specific limited warranty. Some states and provinces do not allow for some disclaimers, limitations and exclusions and, as a result, you have other specific rights.

CUSTOMISING MADE EASY

1

Select the model.

2

Select the package.

3

Customise colour, engine, and accessories (or accessory bundles) for your vehicle.

4

Click "Save" or "Send to dealer".



If you can dream it, you can build it. And ride it. Creating a Can-Am vehicle tailor-made for our riders' needs has never been easier. Scan the QR code and follow the step-by-step above.

**BUILD
YOURS NOW**



CAN-AM DEFENDER

CAN-AM DEFENDER

MODEL PACKAGES

Can-Am Defender DPS HD7	7
Can-Am Defender XU HD9 / HD10	8
Can-Am Defender XU HD9 Competitive Chart	9
Can-Am Defender XT HD10	10
Can-Am Defender XT HD10 Competitive Chart	11
Can-Am Defender Limited HD10	12
Can-Am Defender X mr HD10	13
Can-Am Defender MAX DPS HD9	14
Can-Am Defender MAX XT HD10	15
Can-Am Defender 6x6 DPS HD10	16
Can-Am Defender Pro (Pick-Up) DPS HD10	17

COMPARATIVE CHART

Can-Am Defender Lineup	18
------------------------	----

ACCESSORIES

Roofs	22
Cabs	23
Windshields & Mirrors	24
Doors	27
Rear Wind Protection	29
Aluminum Skid Plates	30
Bumpers & Guards	31
LinQ: Easy On, Easy Off Cargo	35
Cargo & Storage	40
Racks & Holders	43
Lights	46
Audio & Communication Systems	49
Electronic Accessories	50
Winches & Hitches	53
Seats	56
Performance	57
Apache Track Systems	60
ProMount Plows	62
Covers & Add-Ons	66
Tyres & Rims	66



WHAT'S NEW

65" Forward A-Arms:
able to fit up to 30" tyres
For Factory Limited and
X mr packages

2023 CAN-AM DEFENDER DPS HD7



Yellow / HD7

PACKAGE HIGHLIGHTS

- 650 cc single cylinder Rotax Engine
- 27 in. 8 ply XPS Trail Force tyres
- 1,134 kg Towing Capacity
- Rear differential with Turf Mode
- Dynamic Power Steering (DPS™)
- 14 in. cast-aluminium wheels

ENGINE	HD7
Type	52 hp/41 lb-ft, Rotax® ACE (Advanced Combustion Efficiency) 650 cc single cylinder, liquid-cooled
Fuel Delivery System	Intelligent Throttle Control (iTC™) with Electronic Fuel Injection (EFI)
Transmission	pDrive primary CVT with engine braking and Electronic Drive Belt Protection L/H/N/R/P
Drive Train	Selectable Turf Mode/2WD/4WD with Visco-Lok ¹ auto-locking front differential
Driving Assistance	Electronic Hill Descent Control, ECO™/ECO™ Off/Work modes
Power Steering	Dynamic Power Steering (DPS™)

SUSPENSIONS

Front Suspension	Double A-arm/10 in. (25.4 cm) travel
Front Shocks	Twin tube gas-charged shocks
Rear Suspension	TTA with external sway bar/10 in. (25.4 cm) travel
Rear Shocks	Twin tube gas-charged shocks

TYRES & WHEELS

Front Tyres	XPS Trail Force 27 x 9 x 14 in.
Rear Tyres	XPS Trail Force 27 x 11 x 14 in.
Wheels	14 in. cast-aluminum

BRAKES

Front	Dual 220 mm disc brakes with hydraulic twin-piston calipers
Rear	Dual 220 mm disc brakes with hydraulic single-piston calipers

DIMENSIONS & CAPACITIES

Cage	Profiled cage, ROPS approved
Estimated Dry Weight	1,471 lb (667 kg)
L x W x H	121 x 62 x 76 in. (307.1 x 157.5 x 193 cm)
Wheelbase	83 in. (211.5 cm)
Ground Clearance	11 in. (28 cm)
Cargo Box Dimensions	38 x 54.5 x 12 in. (96.5 x 138.4 x 30.5 cm)
Cargo Box Capacity	1,000 lb (454 kg)
Tailgate Load Capacity	250 lb (113.4 kg)
Storage Capacity	Total: 10.4 gal (39.5 L)
Towing Capacity	2,500 lb (1,134 kg)
Payload Capacity	1,500 lb (680 kg)
Fuel Capacity	10.6 gal (40 L)
Person Capacity	3

FEATURES

Gauge	4.5 in. wide digital display
Battery	12 V (18 amp/h)
Magneto	650 W
Instrumentation	DC outlet (10-A)
Lighting	Front lighting output 140 W, LED tail lights
Winch	N/A
Seat	VERSA-PRO bench seat with passenger seats flipping up Underside hooks
Steering Wheel	Adjustable tilt steering
Protection	Integrated front steel bumper, HMWPE central skid plate
Hitch Type	2-in. hitch receiver

WARRANTY & EXTENDED SERVICE

Factory Warranty	2 years / 15,000 km, whichever comes first
Service Intervals	200 hours / 12 months / 3000 km

2023 CAN-AM DEFENDER XU HD9 / HD10



- Yellow / HD9
- Tundra Green / HD9 / HD10

PACKAGE HIGHLIGHTS

- Full Hard Roof
- Brake Hold Mechanism
- Rotax® 976 cc V-twin Engine
- 27 in. 8 ply XPS Trail Force tyres
- 1,134 kg Towing Capacity
- Rear differential with Turf Mode
- Dynamic Power Steering (DPS™)
- 14 in. cast-aluminium wheels

ENGINES	HD9	HD10
Type	65 hp/59 lb-ft, Rotax® 976 cc, V-twin, liquid-cooled	82 hp/69 lb-ft, Rotax® 976 cc, V-twin, liquid-cooled
Fuel Delivery System	Intelligent Throttle Control (iTC™) with Electronic Fuel Injection (EFI)	
Transmission	PRO-TORQ CVT Transmission with Quick Response System (QRS), high-airflow ventilation, and Electronic Drive Belt Protection, Extra L/H/N/R/P	
Drive Train	Selectable Turf Mode/2WD/4WD with Visco-Lok ¹ auto-locking front differential	
Driving Assistance	Electronic Hill Descent Control, ECO™/ECO™ Off/Work modes	
Power Steering	Dynamic Power Steering (DPS™)	

SUSPENSIONS	HD9	HD10
Front Suspension	Double A-arm/ 10 in. (25.4 cm) travel	Arched Double A-arm/ 11 in. (27.9 cm) travel
Front Shocks	Twin tube gas-charged shocks	
Rear Suspension	TTA with external sway bar/ 10 in. (25.4 cm) travel	Arched TTA with external sway bar/ 11 in. (27.9 cm) travel
Rear Shocks	Twin tube gas-charged shocks	

TYRES & WHEELS	
Front Tyres	XPS Trail Force 27 x 9 x 14 in.
Rear Tyres	XPS Trail Force 27 x 11 x 14 in.
Wheels	14 in. cast-aluminum

BRAKES	
Front	Dual 220 mm disc brakes with hydraulic twin-piston calipers
Rear	Dual 220 mm disc brakes with hydraulic single-piston calipers Brake holding mechanism

TALK TO US ABOUT OUR NEW UTILITY KIT (715008856)

- 3 position full glass tilt-up windshield with wipe/washer kit
- Wiper and power cable
- Roof power cable kit
- Full Glass Rear window kit

DIMENSIONS & CAPACITIES	HD9	HD10
Cage	Profiled cage, ROPS approved	
Estimated Dry Weight	1,623 lb (736 kg)	1,645 lb (746 kg)
L x W x H	121 x 62 x 76 in. (307.1 x 157.5 x 193 cm)	121 x 64 x 78 in. (307.1x162.5x198.1 cm)
Wheelbase	83 in. (211.5 cm)	
Ground Clearance	11 in. (27.9 cm)	13 in. (33 cm)
Cargo Box Dimensions	38 x 54.5 x 12 in. (96.5 x 138.4 x 30.5 cm)	
Cargo Box Capacity	1,000 lb (454 kg)	
Tailgate Load Capacity	250 lb (113.4 kg)	
Storage Capacity	Total: 10.4 gal (39.5 L)	
Towing Capacity	2,500 lb (1,134 kg)	
Payload Capacity	1,500 lb (680 kg)	
Fuel Capacity	10.6 gal (40 L)	
Person Capacity	3	

FEATURES

Gauge	4.5 in. wide digital display
Battery	12 V (18 amp/h)
Magneto	650 W
Instrumentation	DC outlet (10-A)
Lighting	Front lighting output 140 W, LED tail lights
Winch	N/A
Seat	VERSA-PRO bench seat with passenger seats flipping up Underside hooks
Steering Wheel	Adjustable tilt steering
Protection	Integrated front steel bumper, HMWPE central skid plate, Full hard roof
Hitch Type	2 in. hitch receiver

WARRANTY & EXTENDED SERVICE

Factory Warranty	2 years / 15,000 km, whichever comes first
Service Intervals	200 hours / 12 months / 3000 km



		Can-Am Defender XU HD9	Polaris Ranger 1000 EPS	Honda Pioneer 700-2	Kawasaki Mule Pro-FX
Engine Size (cc)		976 cc	999 cc	675 cc	813 cc
No of Cylinders		2	2	1	3
Horsepower	+	65 hp	61 hp	36.1 hp	47 hp
Transmission	+	PRO-TORQ CVT Transmission with Quick Response System (QRS)	Automatic PVT (CVT)	3 speed with reverse; manual and automatic modes	Dual range (high/low) CVT with reverse
Front Diff. Type	+	Selectable Turf Mode/ 2WD/4WD with Visco-Lok [†] auto locking front diff.	AWD/2WD/Versatrac turf mode	2WD, 4WD, 4WD Lock	2WD/4WD dual mode differential
Turf Mode	=	Yes	Yes	No	Yes
Power Steering	=	Dynamic Power Steering	Electronic Power Steering	Electric Power Steering	Speed sensitive Electric Power Steering
Hill Descent Assistance	=	Electric hill descent control	No engine braking	Engine braking	Engine braking
Seating Capacity	=	3	3	2	3
Front Suspension	=	Double-A-arm	Dual A-arm	Independent Double-wishbone	Double wishbone
Rear Suspension	+	Torsional trailing arm with external sway bar	Dual A-arm	Independent Double-wishbone	Double wishbone
Wheel Size	+	14"	12"	12"	12"
Wheel Material	+	Aluminium	Steel	Steel	Steel
Tyre Ply Rating	+	8 ply	4 ply	4 ply	4 ply
Towing Capacity	=	1,134 kg	1,134 kg	680 kg	907 kg
Cargo Bed Capacity	=	454 kg	454 kg	408 kg	453 kg
Total Payload	=	680 kg	680 kg	604 kg	733 kg
Ground Clearance		28 cm	30.5 cm	27 cm	26.5 cm
Overall Length		307.1 cm	305 cm	291 cm	338.5 cm
Overall Width		157.5 cm	158 cm	152.5 cm	162.5 cm
Vehicle Dry Weight		736 kg	674 kg	583 kg	824 kg - kerb
Fuel Capacity		40 L	43 L	30 L	30 L
Winch		No	No	No	No
Speed Limiting Device	+	23 kph drivers seatbelt finder, plus optional speed limiting safety keys (40 kph, 70 kph, and open)	Drivers seatbelt limiter 25 kph	Drivers seatbelt limiter 25 kph	No
Warranty Period		2 Years/15,000 km, whichever comes first	1 year Unlimited km	3 years unlimited km	3 years unlimited km

2023 CAN-AM DEFENDER XT HD10



Timeless Black / HD10

PACKAGE HIGHLIGHTS

- 4,500 lb. (2,014 kg) winch
- XT Front bumper
- HMWPE full skid plate
- VERSA-PRO bolster bench seat with reinforced XT seat skin and adjustable drivers seat
- Under passenger seat waterproof removable storage box
- Full Hard Roof
- Brake Hold Mechanism
- Rotax® 976 cc V-twin Engine
- 27 in. 8 ply XPS Trail King tyres
- 1,134 kg Towing Capacity
- Rear differential with Turf Mode
- Dynamic Power Steering (DPS™)
- 14 in. cast-aluminium wheels

ENGINE	HD10
Type	82 hp/69 lb-ft, Rotax® 976 cc, V-twin, liquid-cooled
Fuel Delivery System	Intelligent Throttle Control (ITC™) with Electronic Fuel Injection (EFI)
Transmission	PRO-TORQ CVT Transmission with Quick Response System (QRS), high-airflow ventilation, and Electronic Drive Belt Protection, Extra L/H/N/R/P
Drive Train	Selectable Turf Mode/2WD/4WD with Visco-Lok ¹ auto-locking front differential
Driving Assistance	Electronic Hill Descent Control, ECO™/ECO™ Off/Work modes
Power Steering	Dynamic Power Steering (DPS™)

SUSPENSIONS

Front Suspension	Arched double A-arm/11 in. (27.9 cm) travel
Front Shocks	Twin tube gas-charged shocks
Rear Suspension	Arched TTA with external sway bar/11 in. (27.9 cm) travel
Rear Shocks	Twin tube gas-charged shocks

TYRES & WHEELS

Front Tyres	XPS Trail King 27 x 9 x 14 in.
Rear Tyres	XPS Trail King 27 x 11 x 14 in.
Wheels	14 in. cast-aluminum

BRAKES

Front	Dual 220 mm disc brakes with hydraulic twin-piston calipers
Rear	Dual 220 mm disc brakes with hydraulic single-piston calipers Brake holding mechanism

DIMENSIONS & CAPACITIES

Cage	Profiled cage, ROPS approved
Estimated Dry Weight	1,623 lb (736 kg)
L x W x H	125.7 x 64 x 80 in. (319.4 x 162.5 x 203.2 cm)
Wheelbase	83 in. (211.5 cm)
Ground Clearance	13 in. (33 cm)
Cargo Box Dimensions	38 x 54.5 x 12 in. (96.5 x 138.4 x 30.5 cm)
Cargo Box Capacity	1,000 lb (454 kg)
Tailgate Load Capacity	250 lb (113.4 kg)
Storage Capacity	Total: 16.2 gal (61.3 L)
Towing Capacity	2,500 lb (1,134 kg)
Payload Capacity	1,500 lb (680 kg)
Fuel Capacity	10.6 gal (40 L)
Person Capacity	3

FEATURES

Gauge	4.5 in. wide digital display
Battery	12 V (30 amp/h)
Magneto	650 W
Instrumentation	DC outlet (10-A), USB Port (10-A) x 2
Lighting	Front lighting output 140 W, LED tail lights
Winch	4,500 lb (2,041 kg) winch with roller fairlead
Seat	VERSA-PRO bolster bench seat with passenger seats flipping up, Adjustable driver seat, underside hooks, reinforced XT seat skin.
Steering Wheel	Adjustable tilt steering
Protection	XT front bumper, HMWPE full skid plate, Full hard roof
Hitch Type	2 in. hitch receiver

WARRANTY & EXTENDED SERVICE

Factory Warranty	2 years / 15,000 km, whichever comes first
Service Intervals	200 hours / 12 months / 3000 km



		Can-Am Defender XT HD10	Polaris Ranger XP 1000 HD EPS ADC	Honda Pioneer 1000-3
Engine Size (cc)		976 cc	999 cc	999 cc
No of Cylinders	=	2	2	2
Horsepower	=	82 hp	82 hp	72 hp
Transmission	+	PRO-TORQ CVT Transmission with Quick Response System (QRS)	Automatic PVC	Automatic dual clutch transmission
Front Diff. Type		Selectable Turf Mode/2WD/4WD with Visco-Lok [†] auto-locking front differential	High Performance On-Demand True AWD/2WD/Versatrac turf mode	2WD/4WD/4WD Lock
Turf Mode	=	Yes	Yes	Yes
Power Steering	+	Dynamic Power Steering	Electronic Power Steering	Electric Power Steering
Hill Descent Assistance		Electric Hill descent control	Active Decent Control	Engine braking
Seating Capacity	=	3	3	3
Front Suspension	+	Arched Double A-arm	Dual A-arm	Independent Double-wishbone
Rear Suspension	+	Arched torsional trailing arm with external sway bar	Dual A-arm, IRS	Independent Double-wishbone
Wheel Size	=	14"	14"	12"
Wheel Material	=	Aluminium	Aluminium	Steel
Tyre Ply Rating	=	8 ply	8 ply	6 ply
Tyre Size	=	27"	27"	27"
Towing Capacity	=	1,134 kg	1,133.9 kg	1,134 kg
Cargo Bed Capacity	=	454 kg	454 kg	454 kg
Total Payload		680 kg	871 kg	748 kg
Ground Clearance		33 cm	33 cm	34.5 cm
Overall Length	+	319.4 cm	305 cm	296.6 cm
Overall Width	+	162.5 cm	158 cm	159.9 cm
Vehicle Dry Weight		736 kg	723 kg	703 kg - Kerb
Fuel Capacity		40 L	43.5 L	30 L
Winch	+	Yes - 2,014kg with roller fairlead	No	No
Speed Limiting Device	+	23 kph drivers seatbelt finder, plus optional DESS speed limiting safety keys (40 kph, 70 kph, and open)	24 kph drivers seatbelt limiter	24 kph drivers seatbelt limiter
Anti Theft Device	+	Optional vehicle specific DESS keys - vehicle can not be hot wired	No	No
Warranty Period		2 Years/15,000 km, whichever comes first	1 year unlimited km	3 years unlimited km
Display	+	4.5" wide digital display	4" LCD	Multi-function LCD dash display

2023 CAN-AM DEFENDER LIMITED HD10



Stone Gray / HD10

PACKAGE HIGHLIGHTS

- Auto heating and air conditioning (HVAC) climate system
- Full hard roof with liner and interior dome light
- Full colour match doors with electric opening windows
- 3-position full glass tilt up windshield with wiper/washer kit
- Rear glass window
- Brake holding mechanism
- Panoramic mirror
- VERSA-PRO bolster bench seat with reinforced Limited seat skin and adjustable driver seat
- 7.6 in. digital display with keypad
- Extra wide stable footprint
- LED signature lights
- 30 in. XPS Trac Force tyres
- 4,500 lb (2,014 kg) winch
- XT front bumper
- HMWPE full skid plate

ENGINE	HD10
Type	82 hp/69 lb-ft, Rotax® 976 cc, V-twin, liquid-cooled
Fuel Delivery System	Intelligent Throttle Control (iTC™) with Electronic Fuel Injection (EFI)
Transmission	PRO-TORQ CVT Transmission with Quick Response System (QRS), high-airflow ventilation, and Electronic Drive Belt Protection, Extra L/H/N/R/P
Drive Train	Selectable Turf Mode/2WD/4WD with Visco-Lok ¹ auto-locking front differential
Driving Assistance	Electronic Hill Descent Control, ECO™/ECO™ Off/Work modes
Power Steering	Dynamic Power Steering (DPS™)

SUSPENSIONS

Front Suspension	Arched double A-arm with sway bar/12 in. (30.5 cm) travel
Front Shocks	Twin tube gas-charged shocks
Rear Suspension	Arched TTA with external sway bar/12 in. (30.5 cm) travel
Rear Shocks	Twin tube gas-charged shocks

TYRES & WHEELS

Front Tyres	XPS Trac Force 30 x 9 x 14 in.
Rear Tyres	XPS Trac Force 30 x 10 x 14 in.
Wheels	14 in. cast-aluminum

BRAKES

Front	Dual 220 mm disc brakes with hydraulic twin-piston calipers
Rear	Dual 220 mm disc brakes with hydraulic single-piston calipers Brake holding mechanism

DIMENSIONS & CAPACITIES

Cage	Profiled cage, ROPS approved
Estimated Dry Weight	1,976 lb (896 kg)
L x W x H	126 x 65 x 81 in. (319 x 165.1 x 252 cm)
Wheelbase	83 in. (211.5 cm)
Ground Clearance	14 in. (35.56 cm)
Cargo Box Dimensions	38 x 54.5 x 12 in. (96.5 x 138.4 x 30.5 cm)
Cargo Box Capacity	1,000 lb (454 kg)
Tailgate Load Capacity	250 lb (113.4 kg)
Storage Capacity	Total: 12.7 gal (48.1 L)
Towing Capacity	2,500 lb (1,134 kg)
Payload Capacity	1,200 lb (544 kg)
Fuel Capacity	10.6 gal (40 L)
Person Capacity	3

FEATURES

Gauge	7.6 in. wide digital display with keypad
Battery	12 V (30 amp/h)
Magneto	850 W
Instrumentation	DC outlet (10-A), USB Port (10-A) x 2
Lighting	Front lighting output 140 W, LED signature lights, LED tail lights
Winch	4,500 lb (2,041 kg) winch with roller fairlead
Seat	VERSA-PRO bolster bench seat with passenger seats flipping up. Adjustable driver seat, underside hooks, reinforced seat skin featuring Limited package trims
Steering Wheel	Adjustable tilt steering
Protection	XT front bumper, HMWPE full skid plate, Full hard roof with liner and interior dome light, Full colour match doors with electric opening windows, 3-position full glass tilt-up windshield with wiper/washer kit, Rear glass window Panoramic mirror Auto heating and air conditioning (HVAC) climate system
Hitch Type	2 in. hitch receiver

WARRANTY & EXTENDED SERVICE

Factory Warranty	2 years / 15,000 km, whichever comes first
Service Intervals	200 hours / 12 months / 3000 km

2023 CAN-AM DEFENDER X MR HD10



 Mossy Oak® Break-Up Country Camo / HD10

PACKAGE HIGHLIGHTS

- Smart-Lok front differential
- Strategically positioned engine air intake and CVT inlet/outlet
- Brake holding mechanism
- VERSA-PRO bolster bench seat, reinforced seat skin featuring X package trims and adjustable driver seat
- 7.6 in. digital display with keypad
- Extra high clearance Arched A-Arms
- LED Signature lights
- 30 in. XPS Swamp Force tyres
- 4,500 lb (2,014 kg) High mount winch
- Heavy-duty front steel bumper
- Aluminum rock sliders
- HMWPE full skid plate
- Under passenger seat waterproof removable storage box

ENGINE	HD10
Type	82 hp/69 lb-ft, Rotax® 976 cc, V-twin, liquid-cooled with strategically positioned engine air intake
Fuel Delivery System	Intelligent Throttle Control (iTC™) with Electronic Fuel Injection (EFI)
Transmission	PRO-TORQ CVT Transmission with Quick Response System (QRS), Electronic Drive Belt Protection, lower gearing ratio, and high-airflow ventilation with strategically positioned CVT air intake and exhaust Extra L/H/N/R/P
Drive Train	Selectable Turf Mode/2WD/4WD TRAIL/4WD MUD with exclusive Smart-Lok technology
Driving Assistance	Electronic Hill Descent Control, ECO™/ECO™ Off/Work modes
Power Steering	Dynamic Power Steering (DPS™)

SUSPENSIONS

Front Suspension	Arched double A-arm with sway bar/12 in. (30.5 cm) travel
Front Shocks	Twin tube gas-charged shocks
Rear Suspension	Arched TTA with external sway bar/12 in. (30.5 cm) travel
Rear Shocks	Twin tube gas-charged shocks

TYRES & WHEELS

Front Tyres	XPS Swamp Force 30 x 9 x 14 in.
Rear Tyres	XPS Swamp Force 30 x 11 x 14 in.
Wheels	14 in. cast-aluminum

BRAKES

Front	Dual 220 mm disc brakes with hydraulic twin-piston calipers
Rear	Dual 220 mm disc brakes with hydraulic single-piston calipers Brake holding mechanism

DIMENSIONS & CAPACITIES

Cage	Profiled cage, ROPS approved
Estimated Dry Weight	1,746 lb (792 kg)
L x W x H	129.4 x 64 x 82 in. (328.6 x 162.6 x 208.3 cm)
Wheelbase	83 in. (211.5 cm)
Ground Clearance	15 in. (38.1 cm)
Cargo Box Dimensions	38 x 54.5 x 12 in. (96.5 x 138.4 x 30.5 cm)
Cargo Box Capacity	1,000 lb (454 kg)
Tailgate Load Capacity	250 lb (113.4 kg)
Storage Capacity	Total: 16.2 gal (61.3 L)
Towing Capacity	2,500 lb (1,134 kg)
Payload Capacity	1,500 lb (680 kg)
Fuel Capacity	10.6 gal (40 L)
Person Capacity	3

FEATURES

Gauge	7.6 in. wide digital display with keypad
Battery	12 V (30 amp/h)
Magneto	650 W
Instrumentation	DC outlet (10-A), USB Port (10-A) x 2
Lighting	Front lighting output 140 W, LED signature lights, LED tail lights
Winch	Relocated 4,500 lb (2,041 kg) winch with synthetic rope and roller fairlead
Seat	VERSA-PRO bolster bench seat with passenger seats flipping up. Adjustable driver seat, underside hooks, reinforced seat skin featuring X package trims
Steering Wheel	Adjustable tilt steering
Protection	Heavy-duty front steel bumper, HMWPE full skid plate, Aluminum rock sliders, Mudguards
Hitch Type	2 in. hitch receiver

WARRANTY & EXTENDED SERVICE

Factory Warranty	2 years / 15,000 km, whichever comes first
Service Intervals	200 hours / 12 months / 3000 km

2023 CAN-AM DEFENDER MAX DPS HD9



Tundra Green / HD9

PACKAGE HIGHLIGHTS

- Rotax® 976 cc V-twin engine
- 6 seat capacity
- Longer wheelbase providing smoother ride over rough ground
- 27 in. 8 ply XPS Trail Force tyres
- 771 kg payload / 1,134 kg towing capacity / 454 kg tray capacity
- Rear differential with Turf Mode
- Dynamic Power Steering (DPS™)
- 14 in. cast-aluminium wheels

ENGINE	HD9
Type	65 hp/59 lb-ft, Rotax® 976 cc, V-twin, liquid-cooled
Fuel Delivery System	Intelligent Throttle Control (iTC™) with Electronic Fuel Injection (EFI)
Transmission	PRO-TORQ CVT Transmission with Quick Response System (QRS), high-airflow ventilation and Electronic Drive Belt Protection, Extra L/H/N/R/P
Drive Train	Selectable Turf Mode/2WD/4WD with Visco-Lok ¹ auto-locking front differential
Driving Assistance	Electronic Hill Descent Control, ECO™/ECO™ Off/Work modes
Power Steering	Dynamic Power Steering (DPS™)

SUSPENSIONS

Front Suspension	Double A-arm/10 in. (25.4 cm) travel
Front Shocks	Twin tube gas-charged shocks
Rear Suspension	TTA with external sway bar/10 in. (25.4 cm) travel
Rear Shocks	Twin tube gas-charged shocks

TYRES & WHEELS

Front Tyres	XPS Trail Force 27 x 9 x 14 in.
Rear Tyres	XPS Trail Force 27 x 11 x 14 in.
Wheels	14 in. cast-aluminum

BRAKES

Front	Dual 220 mm disc brakes with hydraulic twin-piston calipers
Rear	Dual 220 mm disc brakes with hydraulic twin-piston calipers

DIMENSIONS & CAPACITIES

Cage	Profiled cage, ROPS approved
Estimated Dry Weight	1,771 lb (803 kg)
L x W x H	153.4 x 63.5 x 76 in. (389.6 x 161.2 x 193 cm)
Wheelbase	115.5 in. (294 cm)
Ground Clearance	11 in. (28 cm)
Cargo Box Dimensions	38 x 54.5 x 12 in. (96.5 x 138.4 x 30.5 cm)
Cargo Box Capacity	1,000 lb (454 kg)
Tailgate Load Capacity	250 lb (113.4 kg)
Storage Capacity	Total: 11.1 gal (42.1 L)
Towing Capacity	2,500 lb (1,134 kg)
Payload Capacity	1,700 lb (771 kg)
Fuel Capacity	10.6 gal (40 L)
Person Capacity	6

FEATURES

Gauge	4.5 in. wide digital display
Battery	12 V (30 amp/h)
Magneto	650 W
Instrumentation	DC outlet (10-A)
Lighting	Front lighting output 140 W, LED tail lights
Winch	N/A
Seat	VERSA-PRO bench seat with passenger seats flipping up Underside hooks
Steering Wheel	Adjustable tilt steering
Protection	Integrated front steel bumper, HMWPE central skid plate
Hitch Type	2 in. hitch receiver

WARRANTY & EXTENDED SERVICE

Factory Warranty	2 years / 15,000 km, whichever comes first
Service Intervals	200 hours / 12 months / 3000 km

2023 CAN-AM DEFENDER MAX XT HD10



Stone Gray / HD10

PACKAGE HIGHLIGHTS

- 6 seat capacity
- 4,500 lb. (2,014 kg) winch
- XT Front bumper
- HMWPE full skid plate
- VERSA-PRO bolster bench seats with reinforced XT seat skin and adjustable drivers seat
- Under passenger seat waterproof removable storage box
- Full Hard Roof
- Brake Hold Mechanism
- Rotax® 976 cc V-twin Engine
- 27 in. 8 ply XPS Trail King tyres
- 1,134 kg Towing Capacity
- Rear differential with Turf Mode
- Dynamic Power Steering (DPS™)
- 14 in. cast-aluminium wheels

ENGINE	HD10
Type	82 hp/69 lb-ft, Rotax® 976 cc, V-twin, liquid-cooled
Fuel Delivery System	Intelligent Throttle Control (ITC™) with Electronic Fuel Injection (EFI)
Transmission	PRO-TORQ CVT Transmission with Quick Response System (QRS), high-airflow ventilation, and Electronic Drive Belt Protection Extra L/H/N/R/P
Drive Train	Selectable Turf Mode/2WD/4WD with Visco-Lok ¹ auto-locking front differential
Driving Assistance	Electronic Hill Descent Control, ECO™/ECO™ Off/Work modes
Power Steering	Dynamic Power Steering (DPS™)

SUSPENSIONS

Front Suspension	Arched double A-arm/11 in. (27.9 cm) travel
Front Shocks	Twin tube gas-charged shocks
Rear Suspension	Arched TTA with external sway bar/11 in. (27.9 cm) travel
Rear Shocks	Twin tube gas-charged shocks

TYRES & WHEELS

Front Tyres	XPS Trail King 27 x 9 x 14 in.
Rear Tyres	XPS Trail King 27 x 11 x 14 in.
Wheels	14 in. cast-aluminum

BRAKES

Front	Dual 220 mm disc brakes with hydraulic twin-piston calipers
Rear	Dual 220 mm disc brakes with hydraulic twin-piston calipers
	Brake holding mechanism

DIMENSIONS & CAPACITIES

Cage	Profiled cage, ROPS approved
Estimated Dry Weight	1,928 lb (875 kg)
L x W x H	158.3 x 64 x 79.5 in. (402 x 162.5 x 202 cm)
Wheelbase	115.5 in. (294 cm)
Ground Clearance	13 in. (33 cm)
Cargo Box Dimensions	38 x 54.5 x 12 in. (96.5 x 138.4 x 30.5 cm)
Cargo Box Capacity	1,000 lb (454 kg)
Tailgate Load Capacity	250 lb (113.4 kg)
Storage Capacity	Total: 16.9 gal (63.9 L)
Towing Capacity	2,500 lb (1,134 kg)
Payload Capacity	1,700 lb (771 kg)
Fuel Capacity	10.6 gal (40 L)
Person Capacity	6

FEATURES

Gauge	4.5 in. wide digital display
Battery	12 V (30 amp/h)
Magneto	650 W
Instrumentation	DC outlet (10-A), USB Port (10-A) x 2
Lighting	Front lighting output 140 W, LED tail lights
Winch	4,500 lb (2,041 kg) winch with roller fairlead
Seat	VERSA-PRO bolster bench seats with passenger seats flipping up. Adjustable driver seat, underside hooks, reinforced XT seat skin.
Steering Wheel	Adjustable tilt steering
Protection	XT front bumper, HMWPE full skid plate, 2-piece full hard roof
Hitch Type	2 in. hitch receiver

WARRANTY & EXTENDED SERVICE

Factory Warranty	2 years / 15,000 km, whichever comes first
Service Intervals	200 hours / 12 months / 3000 km

2023 CAN-AM DEFENDER 6X6 DPS HD10



Tundra Green / HD10

PACKAGE HIGHLIGHTS

- Dynamic Power Steering (DPS™)
- 64 in. wide with Arched A-arm
- 14 in. cast-aluminum wheels
- 27 in. XPS Trail King tyres

ENGINE	HD10
Type	82 hp/69 lb-ft, Rotax® 976 cc, V-twin, liquid-cooled
Fuel Delivery System	Intelligent Throttle Control (iTC™) with Electronic Fuel Injection (EFI)
Transmission	PRO-TORQ CVT Transmission with Quick Response System (QRS), high-airflow ventilation and Electronic Drive Belt Protection, Extra L/H/N/R/P
Drive Train	Selectable Turf Mode/2WD/4WD with Visco-Lok ¹ auto-locking front differential
Driving Assistance	Electronic Hill Descent Control, ECO™/ECO™ Off/Work modes
Power Steering	Dynamic Power Steering (DPS™)

SUSPENSIONS

Front Suspension	Arched double A-arm/11 in. (27.9 cm) travel
Front Shocks	Twin tube gas-charged shocks
Rear Suspension	Arched TTA with external sway bar/11 in. (27.9 cm) travel
Rear Shocks	Twin tube gas-charged shocks

TYRES & WHEELS

Front Tyres	XPS Trail King 27 x 11 x 14 in.
Rear Tyres	XPS Trail King 27 x 11 x 14 in.
Wheels	14 in. cast-aluminum

BRAKES

Front	Dual 220 mm ventilated disc brakes with hydraulic twin-piston calipers
Rear	Dual 220 mm ventilated disc brakes with hydraulic twin-piston calipers

DIMENSIONS & CAPACITIES

Cage	Profiled cage, ROPS approved
Estimated Dry Weight	1,953 lb (886 kg)
L x W x H	154.1 x 64 x 78 in. (391.5 x 162.5 x 198.1 cm)
Wheelbase	115.5 in. (294 cm)
Ground Clearance	13 in. (33 cm)
Cargo Box Dimensions	72 x 54.5 x 10 in. (180.3 x 138.4 x 25.4 cm)
Cargo Box Capacity	1,000 lb (454 kg)
Tailgate Load Capacity	250 lb (113.4 kg)
Storage Capacity	Total: 10.4 gal (39.5 L)
Towing Capacity	3,000 lb (1,360.8 kg)
Payload Capacity	1,700 lb (771 kg)
Fuel Capacity	10.6 gal (40 L)
Person Capacity	3

FEATURES

Gauge	4.5 in. wide digital display
Battery	12 V (18 amp/h)
Magneto	650 W
Instrumentation	DC outlet (10-A)
Lighting	Front lighting output 140 W, LED tail lights
Winch	N/A
Seat	VERSA-PRO bench seat with passenger seats flipping up Underside hooks
Steering Wheel	Adjustable tilt steering
Protection	Integrated front steel bumper, HMWPE central skid plate
Hitch Type	2 in. hitch receiver

WARRANTY & EXTENDED SERVICE

Factory Warranty	2 years / 15,000 km, whichever comes first
Service Intervals	200 hours / 12 months / 3000 km

2023 CAN-AM DEFENDER PRO (PICK-UP) DPS HD10



Yellow / HD10

PACKAGE HIGHLIGHTS

- 712 kg. payload capability
- 6 ft. long tray
- Removable sides - turning the tray into a flatbed
- 316.5 L undertray dust and water resistant storage locker
- Ultrasmooth ride thanks to longer chassis
- One of the quietest SXS on the market
- Rotax® 976 cc V-twin Engine
- 27 in. 8 ply XPS Trail King tyres
- 1,134 kg Towing Capacity
- Rear differential with Turf Mode
- Dynamic Power Steering (DPS™)
- 14 in. cast-aluminium wheels

ENGINE	HD10
Type	82 hp/69 lb-ft, Rotax® 976 cc, V-twin, liquid-cooled
Fuel Delivery System	Intelligent Throttle Control (iTC™) with Electronic Fuel Injection (EFI)
Transmission	PRO-TORQ CVT Transmission with Quick Response System (QRS), high-airflow ventilation, and Electronic Drive Belt Protection Extra L/H/N/R/P
Drive Train	Selectable Turf Mode/2WD/4WD with Visco-Lok ¹ auto-locking front differential
Driving Assistance	Electronic Hill Descent Control, ECO™/ECO™ Off/Work modes
Power Steering	Dynamic Power Steering (DPS™)

SUSPENSIONS

Front Suspension	Arched double A-arm/11 in. (27.9 cm) travel
Front Shocks	Twin tube gas-charged shocks
Rear Suspension	Arched TTA with external sway bar/11 in. (27.9 cm) travel
Rear Shocks	Twin tube gas-charged shocks

TYRES & WHEELS

Front Tyres	XPS Trail King 27 x 9 x 14 in.
Rear Tyres	XPS Trail King 27 x 11 x 14 in.
Wheels	14 in. cast-aluminum

BRAKES

Front	Dual 220 mm disc brakes with hydraulic twin-piston calipers
Rear	Dual 220 mm disc brakes with hydraulic twin-piston calipers

DIMENSIONS & CAPACITIES



Cage	Profiled cage, ROPS approved
Estimated Dry Weight	1,815 lb (823 kg)
L x W x H	154.1 x 64 x 78 in. (391.5 x 162.5 x 198.1 cm)
Wheelbase	115.5 in. (294 cm)
Ground Clearance	13 in. (33 cm)
Cargo Box Dimensions	72 x 54.5 x 10 in. (180.3 x 138.4 x 25.4 cm)
Cargo Box Capacity	1,000 lb (454 kg)
Tailgate Load Capacity	250 lb (113.4 kg)
Storage Capacity	Total: 94 gal (356 L)
Towing Capacity	2,500 lb (1,134 kg)
Payload Capacity	1,570 lb (712 kg)
Fuel Capacity	10.6 gal (40 L)
Person Capacity	3

FEATURES



Gauge	4.5 in. wide digital display
Battery	12 V (18 amp/h)
Magneto	650 W
Instrumentation	DC outlet (10-A)
Lighting	Front lighting output 140 W, LED tail lights
Winch	N/A
Seat	VERSA-PRO bench seat with passenger seat flipping up Underside hooks
Steering Wheel	Adjustable tilt steering
Protection	Integrated front steel bumper, HMWPE central skid plate
Hitch Type	2 in. hitch receiver

WARRANTY & EXTENDED SERVICE

Factory Warranty	2 years / 15,000 km, whichever comes first
Service Intervals	200 hours / 12 months / 3000 km





DEFENDER		DPS	XU	
				
COLOUR OPTIONS		Yellow	Yellow / Tundra Green	Tundra Green
ENGINES	Type	HD7	HD9	HD10
		52 hp/41 lb-ft, Rotax® ACE (Advanced Combustion Efficiency) 650 cc single cylinder, liquid-cooled	65 hp/59 lb-ft, Rotax® 976 cc, V-twin, liquid-cooled	82 hp/69 lb-ft, Rotax® 976 cc, V-twin, liquid-cooled
	Fuel Delivery System	Intelligent Throttle Control (iTC™) with Electronic Fuel Injection (EFI)		
	Transmission	pDrive primary CVT with engine braking and Electronic Drive Belt Protection, L/H/N/R/P	PRO-TORQ CVT Transmission with Quick Response System (QRS), high-airflow ventilation, and Electronic Drive Belt Protection, Extra L/H/N/R/P	
	Drive Train	Selectable Turf Mode/2WD/4WD with Visco-Lok [†] auto-locking front differential		
	Driving Assistance	Electronic Hill Descent Control, ECO™/ECO™ Off/Work modes		
	Power Steering	Dynamic Power Steering (DPS™)		
SUSPENSIONS	Front Suspension	Double A-arm/ 10 in. (25.4 cm) travel	Arched double A-arm/ 11 in. (27.9 cm) travel	
	Front Shocks	Twin tube gas-charged shocks		
	Rear Suspension	TTA with external sway bar/ 10 in. (25.4 cm) travel	Arched TTA with external sway bar/ 11 in. (27.9 cm) travel	
	Rear Shocks	Twin tube gas-charged shocks		
TYRES/ WHEELS	XPS Trail Force 27 x 9/11 x 14 in. 14 in. cast-aluminum			
BRAKES	Front	Dual 220 mm disc brakes with hydraulic twin-piston calipers		
	Rear	Dual 220 mm disc brakes with hydraulic single-piston calipers		
		N/A	Brake holding mechanism	
DIMENSIONS / CAPACITIES	Cage	Profiled cage, ROPS approved		
	Estimated Dry Weight	1,471 lb. (667 kg)	1,623 lb. (736 kg)	1,645 lb. (746 kg)
	L x W x H	121 x 62 x 76 in. (307.1 x 157.5 x 193 cm)		121 x 64 x 78 in. (307.1 x 162.5 x 198.1 cm)
	Wheelbase	83 in. (211.5 cm)		
	Ground Clearance	11 in. (28 cm)		13 in. (33 cm)
	Cargo Box Dimensions	38 x 54.5 x 12 in. (96.5 x 138.4 x 30.5 cm)		
	Cargo Box Capacity	1,000 lb (454 kg)		
	Tailgate Load Capacity	250 lb (113.4 kg)		
	Storage Capacity	Total: 10.4 gal (39.5 L)		
	Towing Capacity	2,500 lb (1,134 kg)		
	Payload Capacity	1,500 lb (680 kg)		
	Fuel Capacity	10.6 gal (40 L)		
	Person Capacity	3		
FEATURES	Gauge	4.5 in. wide digital display		
	Battery	12 V (18 amp/h)		
	Magneto	650 W		
	Instrumentation	DC outlet (10-A)		
	Lighting	Front lighting output 140 W, LED tail lights		
	Winch	N/A		
	Seat	VERSA-PRO bench seat with passenger seat flipping up, underside hooks		
	Steering Wheel	Adjustable tilt steering		
	Protection	Integrated front steel bumper, HMWPE central skid plate	Integrated front steel bumper, HMWPE central steel skid plate, full hard roof	
	Hitch Type	2 in. hitch receiver		

[†]Visco-Lok is a trademark of GKN Viscodrive GmbH.

DEFENDER		XT	Limited	X mr
				
COLOUR OPTIONS		Timeless Black	Stone Gray	Mossy Oak® Break-Up Country Camo
ENGINES	Type	HD10	HD10	HD10
		82 hp/69 lb-ft, Rotax® 976 cc, V-twin, liquid-cooled		82 hp/69 lb-ft, Rotax® 976 cc, V-twin, liquid-cooled with strategically positioned engine air intake
	Fuel Delivery System	Intelligent Throttle Control (iTC™) with Electronic Fuel Injection (EFI)		
	Transmission	PRO-TORQ CVT Transmission with Quick Response System (QRS), high-airflow ventilation, and Electronic Drive Belt Protection, Extra L/H/N/R/P		PRO-TORQ CVT Transmission with Quick Response System (QRS), Electronic Drive Belt Protection, lower gearing ratio, and high-airflow ventilation with strategically positioned CVT air intake, and exhaust Extra L/H/N/R/P
	Drive Train	Selectable Turf Mode/2WD/4WD with Visco-Lok† auto-locking front differential		Selectable Turf Mode/2WD/4WD TRAIL/4WD MUD with exclusive Smart-Lok* technology
	Driving Assistance	Electronic Hill Descent Control, ECO™/ECO™ Off/Work modes		
	Power Steering	Dynamic Power Steering (DPS™)		
SUSPENSIONS	Front Suspension	Arched double A-arm/ 11 in. (27.9 cm) travel	Arched double A-arm with sway bar/ 12 in. (30.5 cm) travel	
	Front Shocks	Twin tube gas-charged shocks		
	Rear Suspension	Arched TTA with external sway bar/ 11 in. (27.9 cm) travel	Arched TTA with external sway bar/ 12 in. (30.5 cm) travel	
	Rear Shocks	Twin tube gas-charged shocks		
TYRES/ WHEELS	Front/Rear Tyres	XPS Trail King 27 x 9/11 x 14 in. 14 in. cast-aluminum	XPS Trac Force 30 x 9/10 x 14 in. 14 in. cast-aluminum	XPS Swamp Force 30 x 9/11 x 14 in. 14 in. cast-aluminum
	Wheels			
BRAKES	Front	Dual 220 mm disc brakes with hydraulic twin-piston calipers		
	Rear	Dual 220 mm disc brakes with hydraulic single-piston calipers		Dual 220 mm disc brakes with hydraulic twin-piston calipers
		Brake holding mechanism		
DIMENSIONS / CAPACITIES	Cage	Profiled cage, ROPS approved		
	Estimated Dry Weight	1,623 lb (736 kg)	1,976 lb (896 kg)	1,746 lb (792 kg)
	L x W x H	125.7 x 64 x 80 in. (319.4 x 162.5 x 203.2 cm)	126 x 65 x 81 in. (319 x 165.1 x 252 cm)	129.4 x 64 x 82 in. (328.6 x 162.6 x 208.3 cm)
	Wheelbase	83 in. (211.5 cm)		
	Ground Clearance	13 in. (33 cm)	14 in. (35.56 cm)	15 in. (38.1 cm)
	Cargo Box Dimensions	38 x 54.5 x 12 in. (96.5 x 138.4 x 30.5 cm)		
	Cargo Box Capacity	1,000 lb (454 kg)		
	Tailgate Load Capacity	250 lb (113.4 kg)		
	Storage Capacity	Total: 16.2 gal (61.3 L)	Total: 12.7 gal (48.1 L)	Total: 16.2 gal (61.3 L)
	Towing Capacity	2,500 lb (1,134 kg)		
	Payload Capacity	1,500 lb (680 kg)	1,200 lb (544 kg)	1,500 lb (680 kg)
	Fuel Capacity	10.6 gal (40 L)		
	Person Capacity	3		
FEATURES	Gauge	4.5 in. wide digital display	7.6 in. wide digital display with keypad	
	Battery	12 V (30 amp/h)		
	Magneto	650 W	850 W	650 W
	Instrumentation	DC outlet (10-A), USB Port (10-A) x 2		
	Lighting	Front lighting output 140 W, LED tail lights	Front lighting output 140 W, LED signature lights, LED tail lights	
	Winch	4,500 lb (2,041 kg) winch with roller fairlead		Relocated 4,500 lb (2,041 kg) winch with synthetic rope and roller fairlead
	Seat	VERSA-PRO bolster bench seat with passenger seats flipping up. Adjustable driver seat, underside hooks, reinforced XT seat skin.	VERSA-PRO bolster bench seat with passenger seats flipping up. Adjustable driver seat, underside hooks, reinforced seat skin featuring Limited package trim.	VERSA-PRO bolster bench seat with passenger seats flipping up. Adjustable driver seat, underside hooks, reinforced seat skin featuring X package trim.
	Steering Wheel	Adjustable tilt steering		
	Protection	XT front bumper, HMWPE full skid plate, full hard roof	XT front bumper, HMWPE full skid plate, full hard roof with liner and interior dome light, full colour match doors with electric opening windows, 3-position full glass tilt-up windshield with wiper/washer kit, rear glass window, panoramic mirror. Auto heating and air conditioning (HVAC) climate system	Heavy-duty front steel bumper, HMWPE full skid plate, aluminum rock sliders, mudguards
	Hitch Type	2 in. hitch receiver		

†Visco-Lok is a trademark of GKN Viscodrive GmbH.

*Smart-Lok was developed in conjunction with TEAM Industries, a market leader in the drive train industry.

DEFENDER		MAX DPS	MAX XT	PRO DPS	6x6 DPS
					
COLOUR OPTIONS		Tundra Green	Stone Gray	Yellow	Tundra Green
ENGINES	Type	HD9	HD10	HD10	HD10
		65 hp/59 lb-ft, Rotax® 976 cc, V-twin, liquid-cooled		82 hp/69 lb-ft, Rotax® 976 cc, V-twin, liquid-cooled	
	Fuel Delivery System	Intelligent Throttle Control (iTC™) with Electronic Fuel Injection (EFI)			
	Transmission	PRO-TORQ CVT Transmission with Quick Response System (QRS), high-airflow ventilation, and Electronic Drive Belt Protection, Extra L/H/N/R/P			
	Drive Train	Selectable Turf Mode/2WD/4WD with Visco-Lok [†] auto-locking front differential			
	Driving Assistance	Electronic Hill Descent Control, ECO™/ECO™ Off/Work modes			
	Power Steering	Dynamic Power Steering (DPS™)			
SUSPENSIONS	Front Suspension	Double A-arm/10 in. (25.4 cm) travel	Arched double A-arm/11 in. (27.9 cm) travel		
	Front Shocks	Twin tube gas-charged shocks			
	Rear Suspension	TTA with external sway bar/10 in. (25.4 cm) travel	Arched TTA with external sway bar/11 in. (27.9 cm) travel		
	Rear Shocks	Twin tube gas-charged shocks			
TYRES/WHEELS	Front/Rear Tyres	XPS Trail Force 27 x 9/11 x 14 in. 14 in. cast-aluminum	XPS Trail King 27 x 9/11 x 14 in. 14 in. cast-aluminum		XPS Trail King 27 x 11 x 14 in. 14 in. cast-aluminum
	Wheels				
BRAKES	Front	Dual 220 mm disc brakes with hydraulic twin-piston calipers			
	Rear	Dual 220 mm disc brakes with hydraulic twin-piston calipers			
		N/A	Brake holding mechanism	N/A	
DIMENSIONS / CAPACITIES	Cage	Profiled cage, ROPS approved			
	Estimated Dry Weight	1,771 lb (803 kg)	1,928 lb (875 kg)	1,815 lb (823 kg)	1,953 lb (886 kg)
	L x W x H	153.4 x 63.5 x 76 in. (389.6 x 161.2 x 193 cm)	158.3 x 64 x 79.5 in. (402 x 162.5 x 202 cm)	154.1 x 64 x 78 in. (391.5 x 162.5 x 198.1 cm)	
	Wheelbase	115.5 in. (294 cm)			
	Ground Clearance	11 in. (28 cm)	13 in. (33 cm)		
	Cargo Box Dimensions	38 x 54.5 x 12 in. (96.5 x 138.4 x 30.5 cm)		72 x 54.5 x 10 in. (180.3 x 138.4 x 25.4 cm)	
	Cargo Box Capacity	1,000 lb (454 kg)			
	Tailgate Load Capacity	250 lb (113.4 kg)			
	Storage Capacity	Total: 11.1 gal (42.1 L)	Total: 16.9 gal (63.9 L)	Total: 94 gal (356 L)	Total: 10.4 gal (39.5 L)
	Towing Capacity	2,500 lb (1,134 kg)			3,000 lb (1,360.8 kg)
	Payload Capacity	1,700 lb (771 kg)		1,570 lb (712 kg)	1,700 lb (771 kg)
	Fuel Capacity	10.6 gal (40 L)			
	Person Capacity	6		3	
	FEATURES	Gauge	4.5 in. wide digital display		
Battery		12 V (18 amp/h)	12 V (30 amp/h)	12 V (18 amp/h)	
Magneto		650 W			
Instrumentation		DC outlet (10-A)	DC outlet (10-A), USB Port (10-A) x 2		DC outlet (10-A)
Lighting		Front lighting output 140 W, LED tail lights			
Winch		N/A	4,500 lb (2,041 kg) winch with roller fairlead	N/A	
Seat		VERSA-PRO bench seat with passenger seats flipping up, underside hooks	VERSA-PRO bolster bench seats with passenger seats flipping up. Adjustable driver seat, underside hooks, reinforced XT seat skin.		VERSA-PRO bench seat with passenger seats flipping up, underside hooks
Steering Wheel		Adjustable tilt steering			
Protection		Integrated front steel bumper, HMWPE central skid plate	XT front bumper, HMWPE full skid plate, 2-piece full hard roof	Integrated front steel bumper, HMWPE central skid plate	
Hitch Type		2 in. hitch receiver			

[†]Visco-Lok is a trademark of GKN Viscodrive GmbH.



ACCESSORIES DEFENDER

ROOFS

Sport Roof	Defender Defender MAX	715002430 715003038
	<ul style="list-style-type: none"> ▪ Robust injection-molded polypropylene construction. ▪ Provides added protection for rider and passenger from the elements. 	
Deluxe Sport Roof <i>(Not illustrated)</i>	Defender Defender MAX	715002511 715003039
<ul style="list-style-type: none"> ▪ Complete roof kit provides extra driver and passenger protection and also diminishes noise within the cab. ▪ Perfect fit and finish thanks to the seal kit and the liners included. ▪ Rear Roof Liner is not compatible with Soft Rear Panel. 		Includes <ul style="list-style-type: none"> - Sport Roof - Sport Roof Seal Kit - Front Roof Liner - Rear Roof Liner
Sport Roof Seal Kit <i>(Not illustrated)</i>	Defender Defender MAX	715003126 715003583
<ul style="list-style-type: none"> ▪ Necessary when installing individual cab components with Sport Roof or when installing the Front and Rear Roof Liners. 		
Bimini Roof with Sun Visor	Defender (not compatible for use with soft and rigid full doors) Defender MAX	■ 715003418 · Black ■ 715003030 · Black
	<ul style="list-style-type: none"> ▪ Heavy-duty canvas made of UV-resistant polyester. ▪ Soft top comes with a hard visor that allows for storage of rolled-up soft top and mounting of Light Rack. ▪ Quick and easy installation. 	
Front Roof Liner	Defender, Defender MAX	715008226
	<ul style="list-style-type: none"> ▪ Vehicle enhancement. ▪ Integrates seamlessly with roof-mounted light switch. ▪ Required for installation of roof-mounted lights and audio systems. ▪ Allows a better integration of Windshield Wiper and Washer Kit. ▪ Seal Kit necessary when installing with Sport Roof. 	
Rear Roof Liner	Defender† Defender MAX* (Not illustrated)	715006334 715006391
	<ul style="list-style-type: none"> ▪ Quick and easy vehicle enhancement. ▪ Allows better integration of other accessories installed on the roof. ▪ Seal Kit necessary when installing with Sport Roof. ▪ Not compatible with: 715002920, 715006680, 715003249, 715002852. 	
<p>†Needs to be installed with Sport Roof (715002430). #Needs to be installed with Sport Roof (715003038).</p>		

CABS

Hard Cabs

Cab Enclosure	Defender XT	715006333
	<ul style="list-style-type: none"> ▪ Rigid cab enclosure ideal for Defender XT vehicles that come stock with a roof, but also fits on Base and DPS models with the addition of a roof. ▪ Offers good driver and passenger protection from the elements. ▪ Rear Wind Protection Installation Seal Kit (715006705) is required for installation on 2020 Defender models. 	<p>Included:</p> <ul style="list-style-type: none"> - Flip Glass Windshield - Full Doors with Power Windows - Rear Window <ul style="list-style-type: none"> - Insulation Acoustic Kit - Window Harness - Roof Power Cable Kit - Hard Enclosure Roof Seal Kit

Clear Rigid Cab	Defender (all model years) Defender MAX 2022 & up (except X mr models)	715007269 715007270
	<ul style="list-style-type: none"> ▪ Includes: <ul style="list-style-type: none"> - Front Clear Rigid Doors - Sport Roof - Flip Glass Windshield - Rear Polycarbonate Window - Sport Roof Seal Kit 	

Premium Rigid Cab Enclosure	Defender (except X mr models)	715008607 715006330 Rear Glass Window with Sliding Panel
	<ul style="list-style-type: none"> ▪ Provides driver and passenger with the best protection from the elements and the cold, and features the most complete top-of-the-line accessories our product lineup has to offer. 	<p>Included:</p> <ul style="list-style-type: none"> - Deluxe Sport Roof Kit - Flip Glass Windshield with Wiper and Washer Kit - Full Doors with Power Windows - Rear Glass Window - Thermal Insulation Kit - Wiper and Powered Windows Cable - Roof Power Cable - Rigid Cab Seal Kit

Premium Rigid Cab Enclosure	Defender MAX (except X mr models)	715008608 715006332 Rear Glass Window with Sliding Panel
	<ul style="list-style-type: none"> ▪ Provides driver and passenger with the best protection from the elements and the cold, and features the most complete top-of-the-line accessories our product lineup has to offer. 	<p>Included:</p> <ul style="list-style-type: none"> - Deluxe Sport Roof Kit - Flip Glass Windshield with Wiper and Washer Kit - Full Doors with Power Windows - Rear Glass Window - Rear Full Doors - Wiper and Powered Windows Cable - Roof Power Cable - Rigid Cab Seal Kit

Deluxe Cab Enclosure	Defender 2022 & up (except X mr models) Defender MAX 2022 & up (except X mr models)	715007417 715007425
	<ul style="list-style-type: none"> ▪ Provides driver and passenger with the best protection from the elements and the cold, and features the most complete top-of-the-line accessories our product lineup has to offer. 	<p>Included:</p> <ul style="list-style-type: none"> - Deluxe Sport Roof Kit - Flip Glass Windshield with Wiper and Washer Kit - Front Deluxe Full Doors and Colour Panels required (sold separately) - Rear Glass Window with Sliding Panel - Wiper and Powered Windows Cable - Roof Power Cable

Soft Cabs

Soft Cab Enclosure *(Not illustrated)*

Defender
Defender MAX 2018 & prior,
Defender MAX 2021 & up (models produced after January 18)

715008063

715008064

Included:

- Sport Roof
- Full Windshield
- Hardcoated
- Soft Doors
- Rear Polycarbonate Window

Cab Kits – Reference Chart

	Cab Enclosure XT	Clear Rigid Cab	Clear Rigid Cab MAX	Premium Rigid Cab Enclosure	Premium Rigid Cab Enclosure (Rear Glass Window with sliding panel)	Premium Rigid Cab Enclosure MAX	Premium Rigid Cab Enclosure MAX (Rear Glass Window with sliding panel)	Soft Cab Enclosure	Soft Cab Enclosure MAX
Kit	715006333	715007269	715007270	715008607	715006330	715008608	715006332	715008063	715008064
Windshield	715002942	715002942	715002942	715002441	715002441	715002441	715002441	715002432	715002432
Rear Window	715007081	715007081	715007081	715007079	715007080	715007079	715007080	715007081	715007081
Roof	Stock	715002430	715003038	715002430	715002430	715003038	715003038	715002430	715003038
Front Doors	715006331	715006261	715006261	715006331	715006331	715006331	715006331	715008059	715008059
Rear Doors	-	-	715006262	-	-	715006329	715006329	-	715006318
Others	710004462 715003094 715003126	715003126	715003583	710004462 715003094 715003126 715008226 715006334	710004462 715003094 715008226 715006334	710004462 715003094 715008226 715006391 715003583	710004462 715003094 715008226 715006391 715003583	-	-

WINDSHIELDS & MIRRORS

Windshields

Powerflip Windshield

Defender, Defender MAX

715003885



- The PowerFlip Windshield is equipped with electric cylinders that allow the rider to adjust the windshield opening at the touch of a button.
- Windshield is made of hardcoated polycarbonate with a rubber seal contour and a tinted top section.
- Allows you to quickly adapt to changing conditions by adjusting the windshield as you go.
- Can be fully opened for optimal visibility and ventilation, fully closed for maximum protection from the elements, and in between, you have an infinite number of opening possibilities depending on protection, visibility and air flow preferences.
- Compatible with Can-Am roofs and windshield wiper and washer kit.
- Not EC compliant.

Flip Glass Windshield

Defender, Defender MAX

715002942



- Curved and laminated glass full windshield in metal frame.
- Provides excellent optical clarity.
- Seals firmly against the cage and protects rider and passenger from the elements while allowing for controlled air flow.
- 3-position flip can be set at fully closed, ¼ open, or fully open.
- Gas-shock-assisted operation and pivots on 2 hinges located at the top of the windshield.
- Ideal for muddy conditions.
- Can be used with Windshield Wiper & Washer Kit (715001638).
- Not EC compliant.







Flip Glass Windshield With Wiper & Washer Kit

Defender, Defender MAX

715002441



- Curved and laminated glass full windshield in metal frame.
- Provides excellent optical clarity.
- Seals firmly against the cage and protects rider and passenger from the elements while allowing for controlled airflow.
- Flip windshield can be set fully closed or fully open according to your preference.
- Ideal for muddy conditions.
- Gas-shock-assisted operation and pivots on 2 hinges located at the top of the windshield.
- Single-speed wiper with washer fluid dispenser.
- Requires Wiper and Power Cables: If equipped with the Sport Roof, Power Cables 710004462 & 715003094 are required. If equipped with the Audio Roof, Power Cables 715008781 & 715003094 are required.
- Not EC compliant.

Windshield Wiper & Washer Kit	Defender, Defender MAX	715001638
	<ul style="list-style-type: none"> • An ideal way to keep your windshield clear in rain, or while riding through mud and water. • Includes single-speed wiper, washer fluid dispenser and windshields frame mount. • Must be used with the Glass Windshield (715001303) or Flip Glass Windshield (715002942) or Powerflip Windshield (715003885). 	<ul style="list-style-type: none"> • Requires Wiper and Power Cables: If equipped with the Sport Roof, Power Cables 710004462 & 715003094 are required. If equipped with the Audio Roof, Power Cables 715008781 & 715003094 are required. Not EC compliant.
Wiper & Power Window Cable <i>(Not illustrated)</i>	Defender, Defender MAX	715008781
<ul style="list-style-type: none"> • Required to install the Audio Roof (715005206 or 715006879) with the following accessories: Flip Glass Windshield with Wiper & Washer Kit (715002441), Windshield Wiper & Washer Kit (715001638), Front Full Doors with Power Windows (715006331), Rear Full Doors (715006329). 		
Wiper & Power Windows Cable <i>(Not illustrated)</i>	Defender, Defender MAX	710004462
<ul style="list-style-type: none"> • Required to install Full Doors with Power Windows (715006331) and/or Windshield Wiper & Washer Kit (715001638). • Necessary if you want to build your own cab enclosure from modular components. 		
Flip Windshield – Hardcoated	Defender, Defender MAX	715002442
	<ul style="list-style-type: none"> • High-impact-resistant Makrolon® hardcoated polycarbonate full windshield in metal frame. • Provides excellent optical clarity and better abrasion resistance. • Seals firmly against the cage and protects rider and passenger from the elements while allowing for controlled air flow. 	<ul style="list-style-type: none"> • 3-position flip can be set at fully closed, ¼ open, or fully open. • Gas-shock-assisted operation. • Ideal for muddy conditions.
Glass Windshield	Defender, Defender MAX	715001303
	<ul style="list-style-type: none"> • Curved and laminated glass full windshield in metal frame. • Seals firmly against the cage and protects rider and passenger from the elements while providing excellent optical clarity. 	<ul style="list-style-type: none"> • Must be used with Windshield Wiper & Washer Kit (715001638) to maintain clear visibility during severe riding conditions. • Not EC compliant.
Full Windshield – Hardcoated	Defender, Defender MAX	715002432
	<ul style="list-style-type: none"> • High-impact-resistant Makrolon® hardcoated polycarbonate full windshield. • Provides excellent optical clarity and better abrasion resistance. • Protects driver and passenger from the elements. • Quick and easy tool-less installation or removal. 	
Full Windshield	Defender, Defender MAX	715002431
	<ul style="list-style-type: none"> • High-impact-resistant durable polycarbonate full windshield. • Formulated to be non-yellowing, non-crazing, non-cracking with excellent UV resistance and optical clarity. 	<ul style="list-style-type: none"> • Protects driver and passenger from the elements. • Quick and easy tool-less installation or removal.
Half Windshield	Defender, Defender MAX	715002433
	<ul style="list-style-type: none"> • High-impact-resistant durable polycarbonate half windshield. • Formulated to be non-yellowing, non-crazing, non-cracking with excellent UV resistance and optical clarity. 	<ul style="list-style-type: none"> • Protects driver and passenger from the elements. • Features reverse angle lip to deflect air flow. • Quick and easy tool-less installation or removal. • Not compatible with Soft Doors.
ProVent Windshield	Defender, Defender MAX	715005276
	<ul style="list-style-type: none"> • High-impact-resistant Quantum hardcoated polycarbonate full windshield. • Optimal performance with Full Cab Enclosure. • Controllable vents to manage air flow. • Channels air into the cabin, defogs windshield, fully closes to eliminate air flow. 	<ul style="list-style-type: none"> • 2 lower vents and one upper vent (pre-filter installed). • Provides excellent optical clarity and better abrasion resistance. • Protects driver and passenger from the elements. • Quick and easy tool-less installation or removal. • Not compatible with wiper kits.

Side Wind Deflectors

Defender, Defender MAX

715005081



- Clear polycarbonate air deflectors mount on each side of the cage.
- Not compatible with Full Doors.
- Sold in pairs.
- Compatible with all windshields.
- Can be adjusted at three different positions for cabin air flow control when a full windshield is installed:
 1. Outside deflection to reduce cabin air flow and turbulence.
 2. Inside deflection to increase air flow in the cabin.
 3. Windshield ventilation to reduce fog.

Side Mirrors

Defender, Defender MAX

715008100 · Black



- Rugged black nylon 6/6 construction with coated cast-aluminum mount.
- Dual adjustment (horizontal and vertical) will suit any rider.
- Convex optics deliver optimal field of view (FOV).
- Spring-loaded pivots let mirrors fold back completely.
- Fit with and without doors and half doors.
- Sold in pairs.

Side Mirror

Defender, Defender MAX 2020 & up

715008101

Defender, Defender MAX 2019 & prior

715002459



- Molded heavy-duty aluminum mirror.
- Stays in place on rough trails.
- Ball-joint design for steady multi-angle adjustment and outstanding vision.
- Use with or without any roof, windshield or doors.
- Not for road use.
- Fits either side.
- Sold individually.

Panoramic Center Mirror

Defender, Defender MAX

715003638



- Wide-angle convex mirror.
- Offers enhanced visibility.
- Can be used with or without roof or windshield and with cab enclosures.

DOORS

Front Deluxe Full Doors

Defender, Defender MAX 2022 & up (except X mr models)

715005214



- Premium doors made from robust polyethylene.
- Offer excellent protection from the elements.
- Easy to remove on hot and sunny days.
- Convenient integrated storage areas.
- Doors' curved design provides even more room.
- Rear-hinge wide opening for ease of ingress/egress in the cockpit.
- Power window delivers added ventilation.
- Compatible with all BRP windshields.
- Require Wiper & Power Windows Cable (710004462), Roof Power Cable (715003094) and Seal Kit (715003126).
- Colour Door Trim are required (sold separately).
- Hardware to install the Door Trim is included.

Rear Deluxe Full Doors

Defender MAX 2022 & up (except X mr models)

715005215



- Premium doors made from robust polyethylene.
- Offer excellent protection from the elements.
- Easy to remove on hot and sunny days.
- Convenient integrated storage areas.
- Curved design provides even more room.
- Rear hinge opens wide for ease of ingress/egress in the cockpit.
- Roll-Down Window delivers added ventilation.
- Require Front Doors (715005214), Wiper and Power Windows Cables (710004462), Power Cable (715003094) and Sport Roof Seal Kit (715003583).
- Colour Door Trim are required (sold separately).
- Hardware to install the Door Trim is included.

Front Deluxe Half Doors

Defender, Defender MAX 2022 & up

715007201



- Premium colour matching doors made from robust polyethylene.
- Premium fit and finish.
- Slim with interior pockets.
- Rear hinge wide opening for ease of ingress/egress in the cockpit.
- Interior and exterior handles.
- Colour accent panels are required (sold separately).
- Hardware to install the Door Trim is included.

Rear Deluxe Half Doors

Defender MAX 2022 & up

715007202



- Premium colour matching doors made from robust polyethylene.
- Premium fit and finish.
- Slim with interior pockets.
- Rear hinge wide opening for ease of ingress/egress in the cockpit.
- Interior and exterior handles.
- Colour accent panels are required (sold separately).
- Hardware to install the Door Trim is included.

Front Door Trim

Defender, Defender MAX 2022 & up



- Customize your Defender by adding colour-matched door panels.

Front Left Door Trim

- **705800818** · Liquid Titanium
- **705800784** · Asphalt Gray
- **705800782** · Mossy Oak Break-Up Country Camo
- **705800810** · Oxford Blue
- **705800814** · Tundra Green
- **705800812** · Timeless Black

Front Right Door Trim

- **705800819** · Liquid Titanium
- **705800785** · Asphalt Gray
- **705800783** · Mossy Oak Break-Up Country Camo
- **705800811** · Oxford Blue
- **705800815** · Tundra Green
- **705800813** · Timeless Black

Rear Door Trim

Defender MAX 2022 & up









- Customize your Defender by adding colour-matched door panels.

Rear Left Door Trim





- **705800832** · Liquid Titanium
- **705800820** · Asphalt Gray
- **705800828** · Mossy Oak Break-Up Country Camo
- **705800822** · Oxford Blue
- **705800826** · Tundra Green
- **705800824** · Timeless Black

Rear Right Door Trim

- **705800833** · Liquid Titanium
- **705800821** · Asphalt Gray
- **705800829** · Mossy Oak Break-Up Country Camo
- **705800823** · Oxford Blue
- **705800827** · Tundra Green
- **705800825** · Timeless Black

Rear Full Doors	Defender MAX produced before January 18, 2021	715006329
	<ul style="list-style-type: none"> • Made from robust high-density polyethylene. • Offer excellent protection from the elements. • Easy to remove on hot and sunny days. • Lockable doors with convenient integrated storage areas. • Curved design provides even more roominess. Rear hinge opens wide for ease of ingress/egress in the cockpit. • Pop-out window delivers added ventilation. 	<ul style="list-style-type: none"> • Requires Wiper & Power Cables and Seal Kit: If equipped with the Sport Roof, Power Cables 710004462 & 715003094 and Seal Kit 715003126 are required. If equipped with the Audio Roof, Power Cables 715008781 & 715003094 and Seal Kit 715003126 are required.
Front Full Doors with Power Windows	Defender & Defender MAX produced before January 18, 2021	715006331
	<ul style="list-style-type: none"> • Made from robust high-density polyethylene. • Offer excellent protection from the elements. • Easy to remove on hot and sunny days. • Lockable doors with convenient integrated storage areas. • Doors' curved-design provides even more roominess. Rear hinge wide opening for ease of ingress/egress in the cockpit. 	<ul style="list-style-type: none"> • Power window delivers added ventilation. • Compatible with all BRP windshields. • Requires Wiper & Power Cables and Seal Kit: If equipped with the Sport Roof, Power Cables 710004462 & 715003094 and Seal Kit 715003126 are required. If equipped with the Audio Roof, Power Cables 715008781 & 715003094 and Seal Kit 715003126 are required.
Half Doors	Defender (2 doors)	715006314
	<ul style="list-style-type: none"> • Half doors made of plastic. • Metal frame for a higher level of fit and finish and rigidity. • Rear hinge wide opening for ease of ingress/egress in the cockpit. • Interior pockets and liners for more protection. 	<ul style="list-style-type: none"> • Defender MAX (4 doors) • 715006318
Soft Doors	Defender (2 doors)	715008059
	<ul style="list-style-type: none"> • Bestop designed soft doors for Can-Am Defender. • Weather-resistant soft doors reinforced with steel frame offer good protection from the elements. • Made of heavy-duty UV-resistant canvas for excellent resistance to tear and abrasion. • Rear hinge wide opening for ease of ingress/egress. 	<ul style="list-style-type: none"> • Defender MAX 2018 & prior, Defender MAX 2021 & up (models produced after January 18) • 715006318 • Zip-down windows made of laminated polished vinyl material for added ventilation. • Easily removable on hot sunny days. • Compatible with roofs and mirrors. • Soft Door Installation Kit (715006238/2X for MAX) is required for installation of 2019 & prior doors, on 2020 Defender models.
Front Clear Rigid Doors	Defender (all model years), Defender MAX 2022 & up (except X mr models)	715006261
	<ul style="list-style-type: none"> • Sturdy and compact steel-frame doors for a robust yet open field of view. • Lower hardcoated polycarbonate transparent panel maximizes visibility around your unit. • Upper portion composed of two tempered-glass sliding windows for unmatched air circulation and versatility. 	<ul style="list-style-type: none"> • EC- and ROHVA-compliant for optimal safety, allowing you to remove the stock side protection bar for increased cabin space. • Sealed contour allows for improved rider comfort in all weather. • Lockable doors for peace of mind.
Rear Clear Rigid Doors	Defender MAX 2022 & up (except X mr models)	715006262
	<ul style="list-style-type: none"> • Sturdy and compact steel-frame doors for a robust yet open field of view. • Lower hardcoated polycarbonate transparent panel maximizes visibility around your unit. • Upper portion composed of two tempered-glass sliding windows for unmatched air circulation and versatility. 	<ul style="list-style-type: none"> • EC- and ROHVA-compliant for optimal safety, allowing you to remove the stock side protection bar for increased cabin space. • Sealed contour allows for improved rider comfort in all weather. • Lockable doors for peace of mind.

REAR WIND PROTECTION

Rear Glass Window with Sliding Panel	Defender, Defender MAX (except X mr models)	715007080
	<ul style="list-style-type: none"> • Made of high-strength tempered glass. • Ideal for preventing backdraft of dust or rain in harsh environments. • Sliding panel for enhanced ventilation. • Quick and easy installation. 	<ul style="list-style-type: none"> • Sport Roof (715002430 or 715003038) required for installation. • Not compatible with Snorkel Kit.
Rear Glass Window	Defender, Defender MAX (except X mr models)	715007079
	<ul style="list-style-type: none"> • Made of high-strength tempered glass. • Ideal for preventing backdraft of dust or rain in harsh environments. • Quick and easy installation. 	<ul style="list-style-type: none"> • Sport Roof (715002430 or 715003038) required for installation. • Not compatible with Snorkel Kit.
Rear Polycarbonate Window	Defender, Defender MAX (except X mr models)	715007081
	<ul style="list-style-type: none"> • High-impact-resistant polycarbonate window. • Ideal for preventing backdraft of dust or rain in harsh environments. • Quick and easy installation. 	<ul style="list-style-type: none"> • Sport Roof (715002430 or 715003038) required for installation. • Not compatible with Snorkel Kit.
Rear Wind Screen	Defender, Defender MAX	715002851
	<ul style="list-style-type: none"> • Full rear mesh screen reduces windshield backdraft for added cabin comfort. • Installs quick and easily on roll cage. • White Can-Am logo at top, to help maintain clear view. 	
Soft Rear Window	Defender, Defender MAX	715003249
	<ul style="list-style-type: none"> • Clear, flexible window made of see-through vinyl. • Resists cold cracking to -4°F (-20°C). • Blocks windshield backdraft or dust and rain from entering, for added cabin comfort. 	<ul style="list-style-type: none"> • Installs quick and easily on roll cage. • White Can-Am logo at top, to help maintain clear view.

ALUMINUM SKID PLATES

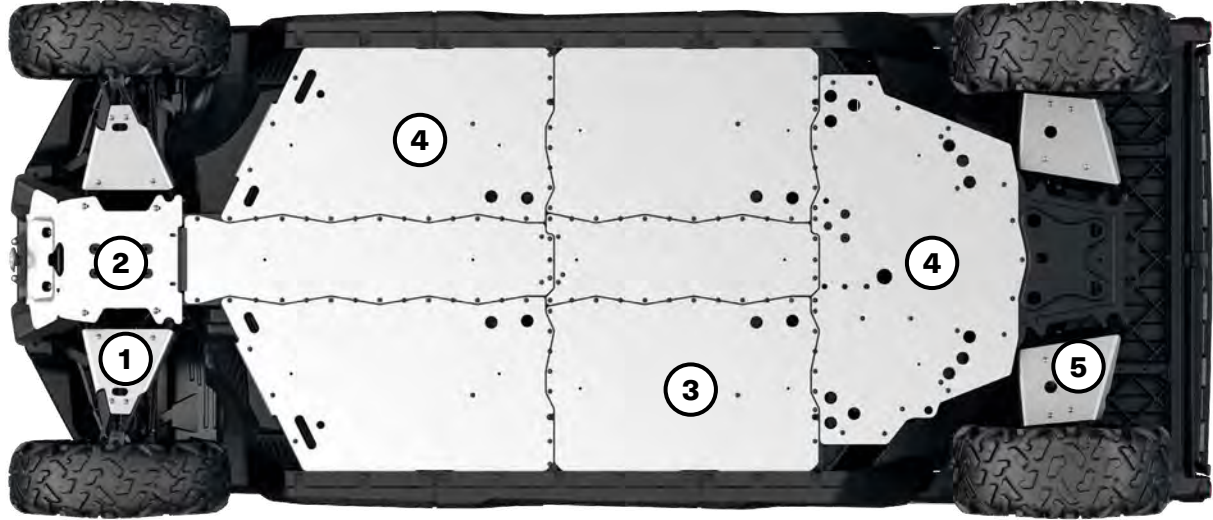

For ultimate durability and strength, all our Aluminum Skid Plates are made with High Strength 5052 H32 Aluminum $\frac{3}{16}$ " (4.5 mm) thick.

- Ultimate durability
- High strength

DEFENDER, DEFENDER MAX

	2019 & prior		2020 & up		
Offer your Defender the full protection kit or get parts individually	Base, DPS, XT, XT-P, XT Cab 2017 & prior & Hunting Edition	XT Cab 2018-2019, Lone Star Edition & X mr	62" Base, DPS (HD5, HD8 & HD9), XT (HD8 & HD9) & PRO (HD8)	64" 6x6 (DPS & XT) or Pro (DPS, XT), XT PRO, DPS (HD10), XT (HD10) & XT-P	67" XT Cab, Hunting Edition, Lone Star Edition, Limited, & X mr
Full Protection Kit					
Aluminum Skid Plate Protection Kit	715003711 (except MAX)	715006977 (3-up)	715006694 (except MAX)	715006696 (3-up & 6x6)	715006979 (3-up 2020 to 2021 only)
	715003712 (MAX only)	715006978 (MAX)	715006695 (MAX only)	715006697 (MAX & PRO)	715006980 (MAX 2020 to 2021 only)
Individual Aluminum Skid Plates					
① Front A-Arm Protectors • Extra underside protection for your vehicle's steering mechanism and suspension (A-Arm). • Sold in pairs. • Not compatible with Apache Track Systems.	715008274	715006975	715008274	715008275	715008275 (2022 & up) 715006975 (2020 to 2021 only)
② Front Skid Plate • Protects the front underside of your vehicle when riding in rough terrain conditions. • Adds style to the front of your vehicle.	715002447	715002447	715002447	715002447	715002447
③ Central Skid Plate Central Skid Plate Kit includes central and lateral skid plates. • Ultra-durable protection for the underside of your vehicle. • Makes work easy in more demanding terrain. • Must be used with Underbelly Skid Plate Kit.	715003467 (MAX only)	715003467 (MAX only)	715003467 (MAX only)	715003467 (MAX only)	715003467 (MAX only)
④ Underbelly Skid Plate Kit • Ultra-durable protection for the underside of your vehicle. • Makes work easy in more demanding terrain. • Kit includes central, lateral and rear skid plates.	715002446	715002446	715007982	715007982	715007982
⑤ Rear A-Arm Protectors • Extra underside protection for your vehicle's suspension (A-Arm). • Sold in pairs. • Not compatible with Apache Track Systems.	715002445	715006976	715002445	715004388	715004388 (2022 & up) 715006976 (2020 to 2021 only)

BUMPERS & GUARDS

Bumpers

Front Bumper	Defender, Defender MAX (2019 & prior)	715002418
	Defender, Defender MAX (2020 & up)	715005754



- Heavy-duty 1.5" (3.8 cm) diameter steel-tube construction.
- Provides enhanced protection.
- Inside and outside anti-corrosion coating with durable powder coat finish.
- Integrated mounting points for lights.
- Required to install the Xtreme Front Bumper Plates, Front Rack and the Front Corner Protectors.

Xtreme Front Bumper Plates	Defender, Defender MAX (2019 & prior)†	715003005
	Defender, Defender MAX (2020 & up)‡	715005777



- Made of high-strength heavy-gauge steel with rubber pads for increased protection.
- Inside and outside anti-corrosion coating with durable powder coat finish.
- Provide additional front-end protection.

†Require Front Bumper (715002418) for installation.
‡Require Front Bumper (715005754) for installation.

Front Corner Protectors	Defender, Defender MAX (2019 & prior)†	715002833
	Defender, Defender MAX (2020 & up)‡	715005774



- Heavy-duty 1.25" (3.2 cm) diameter steel-tube construction.
- Provide enhanced protection for front corners.
- Inside and outside anti-corrosion coating with durable powder coat finish.
- Sold in pairs.

†Require Front Bumper (715002418) for installation
‡Require Front Bumper (715005754) for installation.

Rancher Front Bumper	Defender, Defender MAX	715005410
-----------------------------	------------------------	------------------



- The low front-end protection and plates allow you to use your vehicle within cattle herds and guard the safety of both the vehicle and the animals.
- The flat front portion facilitates gently prodding cattle or pushing light objects, e.g., closing a fence.
- The full frontage coverage extends to provide an extra layer of defense to your headlights and radiator.
- Inside and outside anti-corrosion coating with durable powder coat finish.
- Improved approach angle.
- Compatible with front rack, snow plows, tyre and track kits, winches.

XT Front Bumper	Defender, Defender MAX (2019 & prior)	715004407
------------------------	---------------------------------------	------------------



- 1.5" (3.8 cm) diameter steel-tube construction.
- Provides light-duty protection.
- Inside and outside anti-corrosion coating with durable powder coat finish.
- Light-kit compatible.
- Standard on XT and XT Cab models 2018 and 2019.
- Not compatible with Xtreme Front Bumper Plates, Front Corner Protectors or LinQ Front Rack.

X mr Front Bumper	Defender, Defender MAX	715006143 · Black
--------------------------	------------------------	--------------------------



- Heavy-duty 1.5" (3.8 cm) diameter steel-tube construction.
- Inside and outside anti-corrosion coating with durable finish.
- Provides additional front body protection.
- Integrated winch support plate for winch relocation at a higher position for easier access in muddy conditions or for auxiliary lights.
- Includes a front tow hook.
- Standard on X mr models.
- Winch sold separately.

Cargo Bed Protectors & Tie Rails	Defender 6x6 & PRO models	715005415
---	---------------------------	------------------

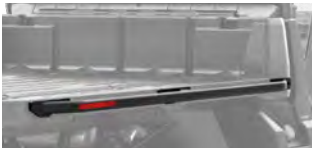

- Heavy-duty 1.5" (3.8 cm) diameter steel-tube construction.
- Reliable cargo box protection and tie-down attachment point to secure large loads.
- Anti-corrosion coating with durable powder coat finish.
- Designed to stay in place when cargo bed side walls are removed.

Rear Bumper	Defender, Defender MAX	715008109
--------------------	------------------------	------------------



- Heavy-duty 1.5" (3.8 cm) diameter steel construction and integrated tubular design.
- Increased protection of rear box and lower box corner while allowing normal tailgate function.
- Inside and outside anti-corrosion coating with durable powder-coat finish.
- Required to install Rear Body Side Protector (715003055).

Rear Bumper Adapter <i>(Not illustrated)</i>	Defender 6x6 & PRO models	715006060
--	---------------------------	------------------

- Required to install the Rear Bumper on Defender models with the long box.

Rear Body Side Protectors	Defender, Defender MAX (except 6x6 & PRO)	715003055
----------------------------------	---	------------------



- Heavy-duty 1.5" (3.8 cm) diameter steel-tube construction.
- Reliable cargo box protection.
- Inside and outside anti-corrosion coating with durable powder coat finish.
- Compatible with fender flares.
- Integrated brush and low-lying branch deflector.
- Require Rear Bumper for installation.
- Sold in pairs.

Body Side Protectors

Front Body Side Protectors	Defender, Defender MAX	715003450
-----------------------------------	------------------------	------------------



- Heavy-duty 1.25" (3.2 cm) diameter steel-tube construction.
- Front side protection for farm, ranch and forestry applications.
- Offer complete front body protection.
- Inside and outside anti-corrosion coating with durable powder coat finish.
- Sold in pairs.
- Require Front Bumper (715002418 or 715005754) with Front Corner Protectors (715002833 or 715005774) and Rock Slider (715002569 or 715003040 for MAX models) for installation.

Front Rancher Body Side Protectors	Defender, Defender MAX	715003617
---	------------------------	------------------



- Heavy-duty 1.25" (3.2 cm) diameter steel-tube construction.
- Front side protection for farm, ranch and forestry applications.
- Offer complete front body protection.
- Inside and outside anti-corrosion coating with durable powder coat finish.
- Sold in pairs.
- Require Rancher Bumper and Rock Sliders for installation.

Fender Flares

Fender Flares

Defender (except 6x6 & PRO), Defender MAX
 Defender 6x6
 Defender PRO

715006821
715005409
715006001

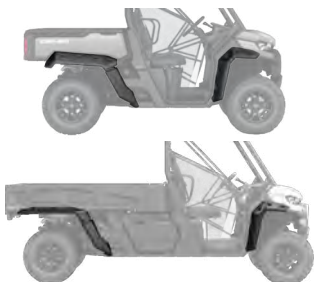

- Robust injection-molded polypropylene construction.
- Perfect for keeping mud and debris outside the vehicle.
- Include front and rear extension, and all mounting hardware.
- Ideal for track equipped vehicles.

Sport Fender Flares

Defender (except 6x6 & PRO), Defender MAX

715003898



- Sleek fender flares just the right size to reduce mud and debris kick-up from your tyres.
- Robust injection-molded polypropylene construction.
- Include front and rear extension, and all mounting hardware.

Rock Sliders

Rock Sliders

Defender
 Defender
 Defender MAX, Defender PRO

■ **715006671** · Black
 ■ **715006675** · Manta Green
 ■ **715006672** · Red
 ■ **715006673** · Yellow
 ■ **715006721** · Black



- Heavy-duty rock sliders made of painted 3/8" (5 mm) aluminum with an integrated step for elevated cargo box access.
- Protect vehicle's sides and undercarriage against large obstacles.
- Lodge tight up against vehicle body for better clearance from obstacles.
- Not compatible with other rock sliders.
- Sold in pairs.
- Standard on Defender X mr, Defender MAX X mr and Defender XT-P models.

Rock Sliders

Defender, Defender 6x6
 Defender MAX, Defender PRO

715002569
715003040



- Protect vehicle's sides and undercarriage against large obstacles.
- Made of heavy-duty 1.5" (3.8 cm) diameter steel tubing.
- Inside and outside anti-corrosion coating with durable powder coat finish.
- Integrated step for easy cargo box access.
- Sold in pairs.

Mud Flaps

Mud Flaps

Defender, Defender MAX

715003041



- Keep mud and debris out of cargo area and protect trailer or vehicles behind you.
- Add aesthetic appeal to your vehicle.
- Made of EPDM rubber.
- Require Rear Bumper for installation.
- Sold in pairs.

S3 for Can-Am

S3 Front Winch Bumper

Defender, Defender MAX (2019 & prior)

■ **715003779** · Black



- Made of 1.5" (3.8 cm) diameter steel tubing with durable powder coat finish.
- Specifically developed for mud riding enthusiasts.
- Integrated mounting plates accommodate all winches.
- Allows higher winch position to avoid winch immersion in mud.
- Added body protection.
- Not compatible with LinQ Front Rack, Removable Winch Mounting Kit, Super-Duty Plow Push Frame Extension and Plow Pulley.
- "S3 for Can-Am" branded.
- Winch not included.

Rear Winch Electrical Harness

(Not illustrated)

Defender, Defender MAX (2019 & prior)

■ **715004233**

- Required for the installation of a winch on the S3 Rear Winch Bumper.
- Compatible with complete Defender winch lineup.

S3 Nerf Bars

Defender, Defender 6x6

■ **715005094** · Sunburst Yellow



- Made of 1.5" (3.8 cm) diameter steel tubing with durable powder coat finish.
- Specifically developed for mud riding enthusiasts.
- Protect vehicle's lower sides without affecting ground clearance.
- Integrated step makes ingress easier.
- Not compatible with Front Body Side Protectors, Front Rancher Body Side Protectors and Apache 360 LT Track System.
- "S3 for Can-Am" branded.

LINQ: EASY ON, EASY OFF CARGO

DEFENDER'S LINQ ACCESSORIES

Mounting location and requirements

<ul style="list-style-type: none"> • No tools needed: Quickly install and remove accessories by hand • Equip your Can-Am for specialized tasks in no time • Sturdy mounting system that holds up to the roughest terrain 	Cargo Bed (long box bed LinQ)	LinQ Cargo Rack 715006140	Adventure Roof Rack 715003870 / 715004391
LinQ Accessories with 16" Base <ul style="list-style-type: none"> • LinQ anchors mounted 16 inches apart, center-to-center. • Lower loading capacity than the LinQ with 36" base accessories. • Can be used on Can-Am ATV and SSV vehicles, Can-Am Spyder and Ryker vehicles, Sea-Doo watercraft and Ski-Doo snowmobiles. 			
LinQ 4.2 Gal Cooler 295100698 • Gray 219400964 • Black	LinQ Base Installation Kit 715008125	LinQ Base Installation Kit 715008125	No compatibility
LinQ Tool Kit 715006829		No further requirements	No further requirements
LinQ Tool Box 715008111			
LinQ SR 5.5 Gal (21 L) Bag 860202449			
LinQ 4.5 Gal (17 L) Sport Bag 860202447			
LinQ Modular Box 715005494 • (10 L) 715007112 • (20 L) 715006830 • (30 L)			
LinQ Roll-Top Bag 715008110	No compatibility		
LinQ Accessories with 36" Base <ul style="list-style-type: none"> • Mount on LinQ racks often used by Can-Am ORV vehicles. • Higher loading capacity than the LinQ with 16" base accessories. • Usage is limited to Can-Am ORV vehicles. 			
LinQ 12 Gal (45 L) Cargo Box 715003879	No compatibility	No further requirements	No further requirements
LinQ 23 Gal (86 L) Trunk Box 715004923			No compatibility
LinQ 11.5 Gal (43 L) Audio Cargo Box 715003018			No further requirements
LinQ 8 Gal (30 L) Cooler Box 715004778 • Black 715004698 • Gray			No further requirements
LinQ Premium Storage Bag by OGIO® 715002923 • Black			No further requirements
LinQ Heavy Duty Basket 715001215			
LinQ Low Profile Basket 715004282			
LinQ Holders			
LinQ Gear Grips 715005340	No further requirements	No further requirements	Side wall installation LinQ Adapters 715003058
LinQ Tool Holder 715007358			

LinQ Accessories with 16" base

LinQ Modular Box	Defender, Defender MAX	715005494 · (10 L) 715007112 · (20 L) 715006830 · (30 L)
	<ul style="list-style-type: none"> ▪ Allows stacking of other modular boxes to always have the right gear accessible. ▪ Always have the right box size to fit everything. ▪ Can be installed on any LinQ base with a 16" width. ▪ See table for installation location and requirements. 	
Thermal Insert for LinQ Modular Box (10 L)	Defender, Defender MAX	219401110
	<ul style="list-style-type: none"> ▪ Insulated liner. ▪ Fits very well in the LinQ Modular Box (10 L). ▪ Can contain five 473 ml cans or six 355 ml cans. 	
LinQ Tool Box	Defender, Defender MAX	715008111
	<ul style="list-style-type: none"> ▪ High precision injected HDPE construction provides rigidity and durability. ▪ 5 gal (19 L) maximum capacity. ▪ Weather-resistant, sealed and lockable cover. ▪ Easy one-second on/off tool-less system. ▪ All the benefits of LinQ—simple, fast and secure. ▪ See table for installation location and requirements. 	
LinQ Tool Kit	Defender, Defender MAX	715006829
	<ul style="list-style-type: none"> ▪ Includes: <ul style="list-style-type: none"> - Cutter pliers - Long-nose pliers - Locking plier - Ratchet wrench 3/8" drive - 6" ratchet extension - Integrated CVT belt storage location (belt not included) - Long-socket 19 mm 3/8" drive - 6pts - Socket 18 mm 3/8" drive - Long-socket 17 mm 3/8" drive - 6pts - Socket 15 mm 3/8" drive - Socket 13 mm 3/8" drive - Socket 10 mm 3/8" drive - Socket 8 mm 3/8" drive - Combined wrench 19 mm - Combined wrench 18 mm - Combined wrench 15 mm - Combined wrench 13 mm - Combined wrench 10 mm - Combined wrench 8 mm - Socket Torx® T40 3/8" drive - Socket Torx® T30 3/8" drive - Socket Torx® T20 3/8" drive - Breaker bar 3/8" drive ▪ See table for installation location and requirements. 	
LinQ 4.2 Gal (16 L) Cooler	Defender, Defender MAX	■ 219400964 · Black ■ 295100698 · Gray
	<ul style="list-style-type: none"> ▪ All the benefits of LinQ—simple, fast and secure. ▪ Rotomolded construction for exceptional rigidity and durability. ▪ Premium-quality foam insulation for optimal ice retention. ▪ Uses LinQ mounting system (Patent US 8777531 and US 8875830). ▪ Easy one-second on/off tool-less system. ▪ See table for installation location and requirements. 	
LinQ SR 5.5 Gal (21 L) Bag	Defender, Defender MAX	860202449
	<ul style="list-style-type: none"> ▪ Semi-rigid expandable bag. ▪ 5.5 gal (21 L) capacity. ▪ See table for installation location and requirements. 	

LinQ 4.5 Gal (17 L) Sport Bag	Defender, Defender MAX	860202447
--------------------------------------	------------------------	------------------



- 4.5 gal (17 L) capacity.
- Rigid bottom, semi-rigid top.
- See table for installation location and requirements.

LinQ Roll-Top Bag	Defender, Defender MAX	715008110
--------------------------	------------------------	------------------



- Fully waterproof roll-top dry bag will securely store and confine your equipment.
- LinQ mounted using heavy-duty rigid plastic base.
- High capacity storage solution (40 L).
- Bottom foam liner for additional equipment protection.
- Integrated handle for easy transportation on/off the vehicle.
- Sea-Doo: marinized LinQ for salt water uses.
- See table for installation location and requirements.

LinQ Accessories with 36" base

LinQ 12 Gal (45 L) Cargo Box	Defender, Defender MAX	715003879
-------------------------------------	------------------------	------------------



- Holds cargo safely and securely while riding.
- See table for installation location and requirements.

LinQ 23 Gal (86 L) Trunk Box	Defender, Defender MAX	715004923
-------------------------------------	------------------------	------------------



- Lockable and weather-resistant.
- Holds cargo safely and securely while riding.
- See table for installation location and requirements.

LinQ 11.5 Gal (43 L) Audio Cargo Box	Defender, Defender MAX	715003018
---	------------------------	------------------



- An affordable and quick solution for adding music and storage to your next ride.
The rear installation does not use up any cab space and allows easy listening at an average speed.
- Mounts on/off easily to hold/carry cargo safely and securely.
- The Bluetooth enabled receiver and 6.5" (16.5 cm) speakers are smartly concealed and integrated in the cover.
- Automatic shut-off function protects your battery by turning the system off after 10 minutes of inactivity.
- Backlit control panel perfect for night riding.
- Water-resistant speakers.
- See table for installation location and requirements.

LinQ 8 Gal (30 L) Cooler Box	Defender, Defender MAX	 715004698 · Gray 715004778 · Black
-------------------------------------	------------------------	--



- Installs without vehicle modification.
- Rotomolded construction provides exceptional rigidity and durability.
- Premium-quality foam insulation for optimal ice retention.
- Integrated, fully removable compartment protects food.
- Robust rubber latches keep the cover tightly closed.
- Weather-resistant.
- Convenient drain plug.
- See table for installation location and requirements.

LinQ Premium Storage Bag by OGIO	Defender, Defender MAX	 715002923 · Black
---	------------------------	--



- 17.2 gal (65 L) capacity semi-rigid cargo bag ideal for carrying anything you need on your vehicle.
- Buckle and elastic closure with a rubber seal that protects dust from entering the bag.
- 3-section lid for partial or full access to your bag.
- Inside separators for optimal bag organization.
- See table for installation location and requirements.

LinQ Heavy-Duty Basket	Defender, Defender MAX	715001215
	<ul style="list-style-type: none"> ▪ Made of high-strength, low-alloy steel. ▪ See table for installation location and requirements. 	
LinQ Low Profile Basket	Defender, Defender MAX	715004282
	<ul style="list-style-type: none"> ▪ Low profile, open basket increases cargo space. ▪ Perfect for easy access to tools, rope, winch and plow accessories. ▪ Multiple bungee cord and tie-down anchor points. ▪ Made of impact-resistant injected polypropylene. ▪ See table for installation location and requirements. 	
LinQ Tailgate Extension	Defender, Defender MAX (except 6x6 and PRO models) Defender 6x6 & PRO	715002464 715005412
	<ul style="list-style-type: none"> ▪ Adds rear cargo capacity when the tailgate is open. ▪ Steel-tubing-system-style barrier mounts on top of the bed walls using the easy, tool-less LinQ System. ▪ Can be mounted to serve as cargo divider at different locations along the bed wall while preventing larger items from falling off the back. ▪ Stores neatly out of the way and offers additional cab area protection since it can be mounted upside down on the front bed wall as a mini headache rack. ▪ Anti-corrosion coating with durable powder coat finish. ▪ Not compatible with hard rear windows on Defender MAX produced before January 2021. 	
LinQ Tyre Holder	Defender (except 6x6 & PRO models), Defender MAX	715003448
	<ul style="list-style-type: none"> ▪ Cargo box spare-tyre holder. ▪ Heavy-duty steel construction. ▪ Inside and outside anti-corrosion coating with durable powder coat finish. ▪ Mounts on top of the bed walls using the easy, tool-less LinQ System. ▪ Compatible with Bed Wall Extender. ▪ Uses BRP standard wheel bolt pattern to mount tyre (nuts included). ▪ Accommodates BRP tyres up to 28" (wheel not included). ▪ Quickly allows installation in multiple positions thanks to the LinQ System. 	
LinQ Cargo Rack	Defender, Defender MAX	715006140
	<ul style="list-style-type: none"> ▪ Strong, durable steel rack. ▪ Easy and tool-less installation thanks to the LinQ System. ▪ Allows the installation of LinQ accessories. ▪ 2 racks can be installed at the same time. ▪ Allows multi-level storage on cargo bed, accommodates 5 gal (19 L) bucket. ▪ Helps keep cargo securely in place. ▪ Multiple bungee cord and tie-down anchor points. ▪ Kit includes LinQ Base. ▪ Provides more usable space in the cargo box. ▪ Extends vehicle cargo options. 	
LinQ Front Rack	Defender, Defender MAX	715006064
	<ul style="list-style-type: none"> ▪ Rugged looking front rack mounts on top of vehicle hood and provides additional storage. ▪ Heavy-duty 1.25" (3.2 cm) diameter steel-tube construction. ▪ Inside and outside anti-corrosion coating with durable powder coat finish. ▪ Flip-up configuration provides easy access to service area. ▪ Allows the installation of LinQ accessories (especially for use with LinQ Low Profile Basket [715004282]). ▪ Kit includes LinQ Base. ▪ Multiple bungee cord and tie-down anchor points. ▪ Requires Rancher Bumper (715005410) or Front Bumper (715002418 or 715005754) for installation. ▪ A great place to store tools while working in the field. ▪ Allows the installation of LinQ Low Profile Basket. 	

LinQ Holders

LinQ Tool Holder

Defender, Defender MAX

715007358



- Ultra-versatile tool holder.
- Convenient swivel-latch allows tools to be stored in any orientation.
- Suitable for installation onto the cargo walls, Deluxe Headache Rack, Bed Wall Extender, Adventure Roof Rack and LinQ Loadout Rack.
- If mounted on the Deluxe Headache Rack or the Bed Wall Extender, LinQ Adapter is required for installation.
- Sold in pairs.

LinQ Gear Grips

Defender, Defender MAX

715005340



- Durable and flexible grips provide a custom fit for a variety of items from 1" to 4" (2.5 cm to 10 cm) in diameter.
- Heavy-duty design for carrying bows, fishing poles, rakes, farm tools and more.
- Quick-release button opens grip quickly for easy access to gear.
- Heavy-duty base system built for the toughest adventures.
- Make transporting your tools a snap by combining the Gear Grips with the LinQ System.
- 360° orientation.
- Sold in pairs.

LinQ Mounting

LinQ Adapter

Defender, Defender MAX

715003058



- Allows the installation of the LinQ Tool Holder to the Bed Wall Extender or the Deluxe Headache Rack.
- Sold in pack of 4.

LinQ Lock

Defender, Defender MAX

860201968



- Simple way to securely lock most LinQ accessories.
- Lock cover protects lock from the elements.
- Corrosion resistant.
- Pack of 1, includes 2 keys.
- Not compatible with LinQ 4.2 US gal (16 L) Cooler, LinQ Tool Box, LinQ Tool Holder or LinQ Gear Grips.

LinQ Base Installation Kit

Defender, Defender MAX

715008125



- Unique mounting fastener usable on any LinQ System accessory.
- Included: 2 LinQ Cargo Bases and hardware.

LinQ Replacement Part

Defender, Defender MAX

715001707



- Unique mounting fastener usable on any LinQ System accessory.
- Tool-less installation and removal.
- Sold in pairs.

CARGO & STORAGE

Loadout Rack

Defender, Defender MAX

715005447



- LinQ installed versatile rack that creates a second level of storage.
- Adjustable height that goes from mid cab height to roof line.
- Modular basket adapts to different cargo with folding front and rear panels.
- Multiple hooks and holes to hang items both inside and outside the rack.
- Basket accommodates multiple LinQ positions.
- Combine with cargo net to create a hanging storage net below the basket for additional space.
- 2 racks can be installed on Defender Pro & Defender 6x6.

Hanging Storage Box Kit

Defender, Defender MAX

715005449



- Versatile rack designed to hold a standard storage box.
- Fully adjustable, the rack can be tailored to hold the crates in multiple positions: headache rack position, inside the box along the sidewall, and outside the box along the side wall.
- Includes Can-Am branded storage box.
- Exterior Cargo Reinforcement Panel is recommended when used outside of bed wall.

Can-Am Storage Box

(Not illustrated)

Defender, Defender MAX

708303237

- Conventional 13" x 13" plastic storage box with Can-Am branding.
- Perforated bottom allows water and debris to escape.

Exterior Cargo Reinforcement Panel

(Not illustrated)

715006198

- Plate that attaches to the bed side to further support and protect bed wall when in outward position.
- Recommended use of the hanging storage box and/or gun and tool holder when installed outside of the bed wall (except Defender 6x6 & PRO).

Deluxe Headache Rack

Defender, Defender MAX

715002423



- Protects cab components from cargo load.
- Increases box capacity when used in tandem with the Bed Wall Extender (715002421).
- Required to install the Bed Wall Extender (715002421).
- Compatible with gear rail.

Headache Rack

Defender, Defender MAX

715003873



- Full rear roll cage coverage offers a heavy-duty steel protective line of defense between your head or cab's components and the load in your cargo bed.
- Compatible with gear rail.
- Rack's open design helps maintain a clear rear view.
- Not compatible with Bed Wall Extender.

Bed Wall Extender

Defender,
Defender MAX (except Defender 6x6 & Defender PRO)
Defender 6x6 & PRO models

715002421

715005411



- Increases box capacity.
- Quick and easy tool-less modularity.
- Easily removable rear door can be latched open.
- Variable full or half height settings.
- Foldable top panels come off in seconds.
- Requires Deluxe Headache Rack (715002423).

Tonneau Cover

Defender 2018 & up (except Mossy Oak Break-Up Country Camo model), Defender MAX

715008306



- Fitted to cover all of the items in your cargo box thoroughly.
- Prevents splash from entering the cargo box.
- Rolls up to the front.
- Easily removable for quick access.
- Not compatible with accessories that exceed the box height.

Removable Storage Bin

Defender, Defender MAX

715004344



- Handy, removable on-dash tool box will make sure you have your critical equipment where you need it.
- Provides 1.7 gal (6.3 L) of storage and clips on and off in a snap.
- Water-resistant to ensure your contents remain safe and dry.
- Standard on all models except Base.

Removable Storage Bin – Passenger

Defender, Defender MAX

715003314



- Convenient passenger-side underseat storage.
- Polypropylene-injected 3.7 gal (14 L) storage capacity bin.
- Bin installs and removes in a snap and comes with an integrated handle.
- Water-resistant.

Driver Underseat Storage Bin

Defender, Defender MAX

715003399



- Polypropylene-injected 4 gal (15 L) capacity bin fits securely under the driver's seat.
- Front opening for quick and easy access.
- Ideal for storing weather-resistant items, such as ropes, tow straps and winch accessories that are needed at a moment's notice.

Center Underseat Storage Bin

Defender, Defender MAX

715003446



- Polypropylene-injected 2 gal (8 L) capacity storage bin.
- Watertight design keeps ice and drinks cold.
- Easy to drain and wash by removing it with integrated handle.
- Accessible by lifting center seat section.

Cargo Bed Rails

Defender (except 6x6 & PRO), Defender MAX

715003444



- Add integrated tie-down area to your cargo box while enhancing the look.
- Added cargo box protection.
- Inside and outside anti-corrosion coating with durable powder coat finish.
- Heavy-duty 1" (2.5 cm) diameter steel-tube construction.
- Add height to the bed side wall and serve as a tie-down anchor for ropes, straps or bungees.
- Not compatible with Bed Wall Extender and Headache Rack (715003873).
- Sold in pairs.

Cargo Bed Net

Defender (except 6x6 & PRO), Defender MAX

715003445



- Solid net designed to hook to the bottom of the cargo box for secure and compact confinement of your cargo.
- Keeps items tightly against the bed floor.

Dash Storage Compartment Net for Heating System	Defender, Defender MAX (2019 & prior)	715003544
--	---------------------------------------	------------------



- Perfect for securing items in the dash storage area.
- To be installed when Lower Dashboard for Heating System is installed.

Lower Dashboard for Heating System	Defender, Defender MAX (2019 & prior)	715003441
---	---------------------------------------	------------------



- Replaces the dashboard that comes stock with the vehicle, and features a tablet that makes it possible for driver and passenger to conveniently store small items in the dash.
- To be installed when the Defrost, Heat & Ventilation System is installed.
- Use together with the Dash Storage Compartment Net for Heating System (715003544) to prevent the items placed in the dash storage compartment from falling.

Dash Storage Compartment Nets	Defender, Defender MAX (except Limited models)	715003129
--------------------------------------	--	------------------



- Perfect for securing items in the dash storage area.
- Not compatible with Defrost, Heat & Ventilation System.
- Sold in pairs.

Bed Tool Box	Defender, Defender MAX	715003028
---------------------	------------------------	------------------



- Large 40 gal (150 L) multifunction weather-resistant tool box designed for cargo beds.
- Rotomolded construction provides exceptional rigidity and durability.
- Features cup holders and integrated groove for pipe or 2x4 cutting.
- Sized to give you the option of installing 2 tool boxes in the cargo bed (quick bolt-on installation).
- Double side openings with lockable covers and rubber latches.

Soft Storage Bag	Defender, Defender MAX	715003759
-------------------------	------------------------	------------------



- 11.8 gal (45 L) capacity soft cargo bag designed with vehicle's rear in mind to maximize potential storage.
- 3 sections.
- Weatherproof.

Backrest Rear Storage	Defender MAX	715003019
------------------------------	--------------	------------------



- Netting installs easily.
- Made from polyester that won't discolour.
- Sold in pairs.

Storage 2.6 Gal (10 L) Bag	Defender, Defender MAX	269502121
-----------------------------------	------------------------	------------------



- Roll-top dry bag for fully protecting your cargo from the elements.

RACKS & HOLDERS

Rear Accessory Bar

Defender, Defender MAX

715005450



- Strong accessory bar allowing installation or hanging items off the back.
- Holes for carabiners, duck decoy hangers or other items.
- LinQ anchors allow installation of many LinQ accessories.

Adventure Roof Rack

Defender
Loads of up to 40 lb (18 kg).

715003870

Defender MAX
Loads of up to 75 lb (34 kg).

715004391



- Ideal cargo solution for packing everything you need to live your Off-Road experience fully and completely.
- Built with heavy-duty 1.25" (3.2 cm) diameter steel tubing.
- Modular LinQ support plates allow for installation of most LinQ cargo accessories.
- Integrated mounting points for lights can hold up to 8 pod-type LED lights (6 front and 2 back) or a 39" (99 cm) LED bar (front)—see table for compatibility.
- Features anchor points for spare tyre attachment.
- Spare Tyre Tie-Downs sold separately.
- Add the Cargo Box Net or the Cargo Box Elastic Net to secure and confine your cargo in the rack.
- Not compatible with Bimini Roof or Audio Roof.

Spare Tyre Ratchet Tie-Downs

Defender, Defender MAX

280000955



- 3-way ratcheting tie-down strap with loop ends.
- Designed to securely hold spare tyres on accessories equipped with integrated spare tyre attachment points.
- Adjustable to accommodate most common UTV tyre sizes.
- Ratchet and junction ring made of durable zinc-plated steel.
- Required for spare tyre attachment on Adventure Roof Rack.

LinQ Tool & Gun Holder

Defender, Defender MAX (except 6x6 and PRO models)

715005466



- 2-in-1 holding rack can be used both on the job or on the hunt.
- Includes 5 locations to securely hold tools and guns using rubber grips and retention straps at the top and a rubber mat with gunstock shaped molding at the bottom.
- Easy to remove, install or reposition using our simple and secure LinQ System.
- Can be attached at multiple positions along the cargo bed walls, facing inside or outside the bed.
- Recommended to use with the Exterior Cargo Reinforcement Panel (715006198) when installed outside the bedwall.

LinQ Gun Case

Defender, Defender MAX

715004968



- Practical design allows you to store shotguns and rifles up to 52" (132 cm) even with most optic configurations.
- Adapt to different weapon shapes and features with foam cushions that can be repositioned.
- LinQ-mounted for efficient and secure storage, locked in place with only a quarter turn.

LinQ Gun Case Mounting Kit







Defender, Defender MAX

715006443

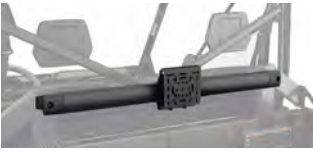

- Required to install the LinQ Gun Case on a Defender and Defender MAX.
- Allows you to install up to two LinQ gun cases.

Gun Boot 6.0[†] Impact by Kolpin[†]	Defender, Defender MAX	715001419
	<ul style="list-style-type: none"> ▪ Extra room for pistol-grip-type weapons and small bipods. ▪ Easily fits firearms up to 51" (1.3 m) in total length. ▪ Provides ample room for 2.4" (60 mm) scopes. ▪ Hatchback design allows easy access. ▪ Snap-close cover with locking capability. ▪ Ergonomically designed handle and molded attachment points for sling. ▪ Designed to accommodate left- and right-hand bolt-action rifles and shotguns. ▪ Requires Gear Rail and Gun Boot Mount by Kolpin for installation. ▪ Includes removable, shock-absorbing foam and nylon Impact liner for superior interior protection. ▪ Compatible for dual mount with additional Gun Boot Mount. 	
Stronghold Gun Boot Impact[†] by Kolpin[†]	Defender, Defender MAX	705011442
	<ul style="list-style-type: none"> ▪ Compact low-profile design with Kolpin Stronghold styling securely holds up to 52" (132 cm) long rifles and shotguns with optics. ▪ Includes a removable, shock absorbing foam Impact[†] liner. ▪ Single-handed opening with an attached lid for quick access along with an integrated closure strap. ▪ For use with the Kolpin Stronghold Auto Latch Mount System. 	
Stronghold Auto-Latch Mount by Kolpin	Defender, Defender MAX (except X mr models)	715003899
	<ul style="list-style-type: none"> ▪ Auto-latching design provides quick and secure gun boot attachment to your vehicle. ▪ Bracket is made from rugged high impact, reinforced nylon and coated steel. ▪ For use with Stronghold Gun Boot. ▪ Requires Gear Rail for Stronghold (715004089). 	
Gear Rail For Stronghold	Defender, Defender MAX	715004089
	<ul style="list-style-type: none"> ▪ Designed for the Stronghold Auto-Latch Mount by Kolpin. ▪ Can hold up to two Stronghold Gun Boots (two Latch mounts required). ▪ Deluxe Headache Rack (715002423) or Gear Rail Adapter (715003392) required. 	
Gun Boot Mount by Kolpin	Defender, Defender MAX	715001420
	<ul style="list-style-type: none"> ▪ Fits one Kolpin Gun Boot 6.0 Impact. ▪ Lightweight and extremely durable. ▪ Easily adjustable without the use of any tools. ▪ Offers precision gun angle adjustability. ▪ Requires Gear Rail for installation. 	
Additional Gun Boot Mount <i>(Not illustrated)</i>	Defender, Defender MAX	715001586
Dual Gun Holder	Defender, Defender MAX	715005265
	<ul style="list-style-type: none"> ▪ Accommodates shotguns, rifles or muzzleloaders. ▪ Mounts in the cab, on floor board between driver and passenger. ▪ Rubber pads provide gun protection. ▪ Can be removed to allow a center passenger. ▪ Anti-corrosion coating with durable powder coat finish. ▪ Comes with all hardware for easy installation. ▪ Keeps your weapons within easy reach and protected within the cab area. ▪ Refer to your local regulations governing the transportation of firearms before purchase. 	

Gear Rail	Defender, Defender MAX (except X mr models)	715003391
	<ul style="list-style-type: none"> • Stationary rail system specially designed for your side-by-side vehicle. • Universal mounting options for many Kolpin accessories like Gear Grips and Universal Saw Press. • Rail is made with heavy-duty 7-gauge extruded anodized black aluminum. • Mounts on roll bar. • Includes one versatile Gear Rail Mount by Kolpin. • Requires Deluxe Headache Rack (715002423), Headache Rack (715003873) or Gear Rail Adapter (715003392). 	
Gear Rail Adapter	Defender, Defender MAX (except X mr models)	715003392
	<ul style="list-style-type: none"> • Allows the installation of gear rails directly onto the cargo box without the need for a headache rack. 	
Gear Rail Mount by Kolpin	Defender, Defender MAX	715001422
	<ul style="list-style-type: none"> • Accessory bracket for mounting additional accessories to the Gear Rail. • Includes C-clamp and metal mounting brackets. 	
Double Gun Bag	Defender (except XT Cab, X mr models), Defender MAX (except XT Cab and Limited package)	<ul style="list-style-type: none"> ■ 715003133 · Black ■ 715003134 · Mossy Oak Break-Up Country Camo
	<ul style="list-style-type: none"> • Shell constructed with heavy-duty, weather-resistant polyester to shelter guns from dust and other outdoor elements, while the thick interior padding protects the guns from shocks. • Fits perfectly on rear cage, and guns are readily accessible from both sides of vehicle. • Design features include a removable center pocket that can be mounted on both sides of the bag, and extra front storage pockets for hunting gear. • Solid, quick installation. • Not compatible with rear wind protection, headache racks and gear rails. • May interfere with the tilt function of the Defender 6x6 or Defender PRO models' bed. 	
Universal Saw Press by Kolpin	Defender, Defender MAX (except X mr models)	715001423
	<ul style="list-style-type: none"> • Specially crafted for transporting your chainsaw securely and safely aboard your side-by-side vehicle. • Heavy-duty, black powder-coated metal bracket designed to attach any chainsaw model with up to a 20" (51 cm) bar. • Rubber pads provide cushion and tight fit. • Hinged design for quick removal. • Holds saw in vertical position or 45° angle in either direction. • Requires Gear Rail. • Protective sheath included. 	
LinQ Gear Grips	Defender, Defender MAX	715001421
	<ul style="list-style-type: none"> • Durable, flexible grips cushion and protect while providing a custom fit for a variety of items from 1" to 4" (2.5 cm to 10 cm) in diameter. • Heavy-duty design for carrying bows, fishing poles, rakes, farm tools and more. • Quick-release button opens grip quickly for easy access to gear. • Heavy-duty base system built for the toughest adventures. • Easy installation on tubular racks, extension racks, brackets or bumpers. • Sold in pairs. 	

LIGHTS

1 Choose your mount point		2 Find your platform		3 Choose your lights		
		10" (25 cm) Double Stacked LED Bar	15" (38 cm) Double Stacked LED Bar	39" (99 cm) Double Stacked LED Bar	4" (10 cm) Round LED LIGHTS (Sold in pairs)	3.5" (9 cm) LED Lights (Sold in pairs)
Front Bumper Rancher Bumper XT Front Bumper X mr Front Bumper (w/o winch) X-TP Front Bumper	Defender Defender MAX 2019 & prior	715002933 PLUS 715002454 (Light Power Cable)	715002934 PLUS 715002454 (Light Power Cable)	N/A	715002935 (4" Round), 715003665 (3.5" Flood) or 715003666 (3.5" Spot) PLUS 715002454 (Light Power Cable)	
	Defender Defender MAX 2020 & up	715002933 PLUS 715006034 (Light Power Cable)	715002934 PLUS 715006034 (Light Power Cable)	N/A	715002935 (4" Round), 715003665 (3.5" Flood) or 715003666 (3.5" Spot) PLUS 715006034 (Light Power Cable)	
Light Rack or Light Bars <i>*Roof Power Cable and Front Roof Liner may not be required if already installed with other accessories.</i>	Defender & Defender MAX (except XT Cab)	715002933 PLUS 715003094 (Roof Power Cable) & 715008226 (Front Roof Liner)	715002934 PLUS 715003094 (Roof Power Cable) & 715008226 (Front Roof Liner)	715006226 (Light Bar Support) PLUS 715004007 (39" Light Bar) PLUS 715005822 (Power Cable) & 715008226 (Front Roof Liner)	715002935 (4" Round), 715003665 (3.5" Flood) or 715003666 (3.5" Spot) PLUS 715003094 (Roof Power Cable) & 715008226 (Front Roof Liner)	
	Defender Defender MAX XT Cab Limited	715002933	715002934	715006226 (Light Bar Support) PLUS 715004007 (39" Light Bar) PLUS 715005822 (Power Cable)	715002935 (4" Round), 715003665 (3.5" Flood) or 715003666 (3.5" Spot)	
Adventure Roof Rack <i>*Roof Power Cable may not be required if already installed with other accessories.</i>	Defender & Defender MAX (except XT Cab Limited)	N/A	Front only: 715002934 PLUS 715003417 (Power Cable) & 715003094 (Roof Power Cable) & 715008226 (Front Roof Liner)	Front only: 715004007 PLUS 715005822 (Power Cable) & 715003094 (Roof Power Cable) & 715008226 (Front Roof Liner)	Front or Rear: 715002935 (4" Round), 715003665 (3.5" Flood) or 715003666 (3.5" Spot) PLUS 715003417 (Power Cable) & 715003094 (Roof Power Cable) & 715008226 (Front Roof Liner)	
	Defender, Defender MAX XT Cab Limited	N/A	Front only: 715002934 PLUS 715003417 (Power Cable)	Front only: 715004007 PLUS 715005822 (Power Cable)	Front or Rear: 715002935 (4" Round), 715003665 (3.5" Flood) or 715003666 (3.5" Spot) PLUS 715003417 (Power Cable)	

4 Order **Order all part numbers in intersecting box**
**Note: When installing more than one light kit, additional light power cable or mounting kit is required.*

Roof Power Cable <i>(Not illustrated)</i>	Defender, Defender MAX	715003094
---	------------------------	------------------

- Required for installation of some electrical accessories.
- Brings power from the battery.

Light Kit Power Cable <i>(Not illustrated)</i>	Defender, Defender MAX (2019 & prior)	715002454
	Defender, Defender MAX (2020 & up)	715006034

- Power cable for installation of compatible Can-Am light kits at front bumper location.

10" (25 cm) Double Stacked LED Light Bar (60 W)

Defender, Defender MAX

715002933



5,400 lumens

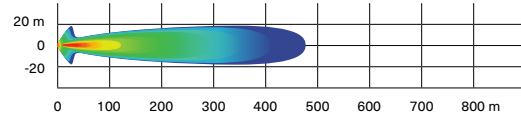

- Equipped with twelve 5 W Cree LEDs.
- 5,400 lumens.
- Packs a big punch for its size.
- Rugged and waterproof.
- Can be installed on front bumpers, sport roof and Bimini roof with sun visor.
- Requires light power cable for installation.
- Lights up to more than 1,500 ft (460 m) in front of the vehicle and around 65 ft (20 m) wide on each side.
- EC compliant.

15" (38 cm) Double Stacked LED Light Bar (90 W)

Defender, Defender MAX

715002934



8,400 lumens

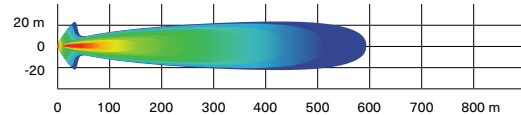

- Equipped with 18 5 W Cree LEDs.
- 8,400 lumens.
- Complements the Light Racks and most bumpers.
- Rugged and waterproof.
- Lights up to more than 1,900 ft (580 m) in front of the vehicle and around 65 ft (20 m) wide on each side.
- EC compliant.

39" (99 cm) Double Stacked LED Light Bar (270 W)

Defender, Defender MAX

715004007



24,300 lumens

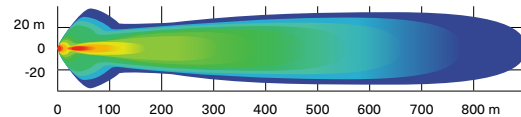

- Equipped with 54 5W Cree LEDs.
- 24,300 lumens.
- Lights up to more than 2,900 ft (900 m) in front of the vehicle and around 115 ft (35 m) wide on each side.
- Compatible on the Adventure Roof Rack.
- Compatible with Flip Windshield, Full Windshield and Can-Am Intrusion Bar if the Light Bar Support (715006226) and/or Mounting Kit For 39" (99 cm) LED Light Bar (715005822) is installed.

4" (10 cm) Round LED Lights (2 x 25 W)

Defender, Defender MAX

715002935



1,800 lumens

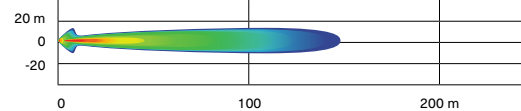

- 25 W LED spotlights.
- 1,800 lumens.
- Rugged and waterproof.
- Includes basic wiring and switch.
- Can-Am branded grill.
- Requires light power cable.
- Sold in pairs.
- Not EC compliant.

3.5" (9 cm) LED Driving Lights (2 x 14 W)

Defender, Defender MAX

715003666



1,260 lumens

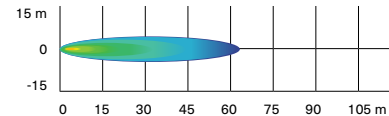

- 14 W LED lights producing 1,260 lumens each.
- Spot lens for a narrow and long light beam spread, ideal when driving at higher speeds.
- Equipped with six high-power LEDs in a heavy-duty die-cast aluminum housing.
- Features two attachment points. If one attachment point fails due to a collision, rotate to the next channel point and remount the light.
- Sold in pairs.
- EC compliant.

3.5" (9 cm) LED Flood Lights (2 x 14 W)

Defender, Defender MAX

715003665

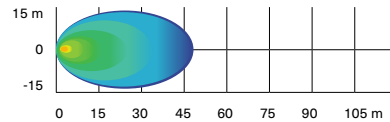

- 14 W LED lights producing 1,260 lumens each.
- Flood lens for a wide light beam spread, ideal for working applications like plowing or cornering. Suitable for dusty or foggy riding conditions.
- Equipped with six high-power LEDs in a heavy-duty die-cast aluminum housing.

- Features two attachment points. If one attachment point fails due to a collision, rotate to the next channel point and remount the light.
- Sold in pairs.
- EC compliant.

Light Bar Support

Defender, Defender MAX

715006226



- Mounting Bracket that allows the installation of the Can-Am 39" Lightbar (715004007).
- Low and forward mounting position for a sleek look.
- Compatible with all windshields, roofs and doors.

Light Rack

Defender, Defender MAX

715002456



- Rugged steel construction serves as both mount and protection for accessory light systems.
- Lights not included.
- Front Roof Liner is required for installation on the roof (except Cab models or with Deluxe Sport Roof).
- Power Cable, Sport Roof, Deluxe Sport Roof or Sport Roof for MAX required for installation.
- Integrates elegantly and seamlessly into our roof products.

Rear Cargo Light

Defender, Defender MAX (2020 & up)

715007077



- Powerful 55W H3 illumination for rear cargo area.
- Convenient in-dash switch.
- Wiring included.
- Sport Roof (715002430), Deluxe Sport Roof (715002511) or Sport Roof for MAX (715003038) is required for installation.
- Not EC compliant.
- Not compatible with headache rack on Defender Pro and Defender 6x6.

RAM[†] LED Spotlight

Defender, Defender MAX (2019 & prior)

710005423



- 540 lumens LED light (9 watt) heavy-duty spotlight standard-equipped with 1" (2.5 cm) diameter rubber-coated double ball and socket system.

Dome Light

Defender, Defender MAX

715002455



- LED array integrates perfectly with vehicle.
- Wiring included.
- Can be installed on cage or roof, with or without roof liner.

LED Signature Lights

Defender, Defender MAX (2020 & up)

715006896



- The stylish LED set puts the finishing touch to your Defender, accentuating its aggressive stance.
- Included on Limited and Lone Star models.

AUDIO & COMMUNICATION SYSTEMS

Can-Am Audio Roof

Defender

715005206



- Full roof with sleek built-in audio.
- Fully sealed and waterproof.
- Easy to install: one wire connects the roof to the vehicle's electronics.
- Four 8" speakers, one 280 watt amplifier, and one weatherproof source unit supplied by JL Audio¹.
- Speakers include LED lighting integrated into the grille, designed to uniformly illuminate with an RGB glow.
- A 3" full-colour LCD display, with separate day/night lighting themes for visibility, even in bright sunshine.
- AM/FM tuner.
- To install the Audio Roof with the following accessories, the Power Harnesses 715003094 & 715008781 are required:
Flip Glass Windshield With Wiper & Washer Kit (715002441), Windshield Wiper & Washer Kit (715001638), Front Full Doors With Power Windows (715006331), Rear Full Doors (715006329), Front Deluxe Full Doors (715005214), Rear Deluxe Full Doors (715005215).
- Not compatible with Adventure Roof Rack.

Can-Am Audio Roof MAX

Defender MAX

715006879



- Full roof with premium JL Audio system for Defender MAX.
- Fully sealed and waterproof components and construction.
- Simple to install: one connector connects the roof to the vehicle's electrical system.
- Weatherproof components: Six 7.7" coaxial speakers, 280 watt amplifier and 70 watt Mediamaster[®] source unit.
- AM/FM tuner.
- Expertly tuned for exceptional sound on the move in your Defender MAX.
- Speakers include adjustable RGB LED cone illumination, controlled via an app on your smartphone.
- Mediamaster[®] source unit equipped with 3" full-colour LCD display, with day/night lighting modes.
- Designed to not drain the battery.
- Specific to the type of riding.
- To install the Audio Roof with the following accessories, the Power Harnesses 715003094 & 715008781 are required:
Flip Glass Windshield With Wiper & Washer Kit (715002441), Windshield Wiper & Washer Kit (715001638), Front Full Doors With Power Windows (715006331), Rear Full Doors (715006329), Front Deluxe Full Doors (715005214), Rear Deluxe Full Doors (715005215)
- Not compatible with Adventure Roof Rack.

Wetsound Stealth XT 6 Can-Am Edition Sound Bar

Defender, Defender MAX

715008282



- Built-in Bluetooth connectivity with source control.
- Built-in Broadcast mode.
- Backlit control panel with Integrated LED RGB cabin lights.
- Integrated LED Dome.
- IP67 rated RF wireless remote control.
- 3.5 aux input/output.
- Built-in 300 W Class D Amplifier.
- 4 marine-rated 3" full range drivers.
- 2 marine-rated 1" tweeters.
- Operating voltage: 12 V.
- IP rated: IP67.
- Length: 21.31"
- Width: 4.04"
- Height: 3.85"
- Sound Bar Mounting Kit required for installation.

Sound Bar Mounting Kit

Defender, Defender MAX

715007840



- Required to install the Wetsound Stealth XT 6 Can-Am Edition Sound Bar on a Defender and Defender MAX.

Overhead Audio System



- Rugged waterproof Jensen¹ Bluetooth Stereo Audio System offers multi-source input: AM/FM/WB and USB (iPod[®] and iPhone[®] ready).
- Convenient white LED-backlit LCD display and buttons.
- Stream from any Bluetooth-enabled device (smartphone, MP3 player).
- Powerful 4x40W amplifier with remote turn-on.
- Voice-control of AVRCP-active device.
- 30 programmable AM/FM stations with auto-store/pre-set scan.
- Separate RCA audio output and input.
- UV-resistant finish/corrosion-resistant components.
- Requires Sport Roof (715002430), Front Roof Liner (715008226) or Deluxe Sport Roof (715002511) and Power Cable (715003094).

Complete Overhead Audio System

Defender, Defender MAX

715002019

- Complete with 4 ultra-sturdy outdoor speakers (2 front and 2 rear) and 4 black speaker boxes.

Overhead Front Audio System

Defender, Defender MAX

715003095

- Complete with 2 ultra-sturdy front outdoor speakers and black speaker box.

Rugged Radios Car-to-Car System	Defender, Defender MAX	715003440 · US ONLY
--	------------------------	----------------------------



- Perfect for communicating with friends and family on group rides.
 - Push-to-talk button conveniently mounted on the steering wheel.
 - May be connected with the Rugged Radios Intercom System (with provided adapter cable).
- This kit includes:
- 5-watt V3 Radio: UHF/VHF + FM frequency, programmable channels, 5 watts of power, includes belt clip, recharging cable, high capacity, all day lithium-ion battery, 1-3 mile range, NOAA weather channels, 1-touch FM radio, backlit screen/buttons.
 - Helmet Speaker/Mic Kit: Clear Hear audio speakers, Full Flex mic boom, cloth mic cover, Velcro mount speakers, quick & easy install.
 - Harness & Cables: Single Person Harness, Driver Coil Cord PTT, waterproof PTT, radio mounting bracket, complete plug & play kit.

Rugged Radios Intercom System	Defender, Defender MAX	715002891 · US ONLY
--------------------------------------	------------------------	----------------------------



- Specifically designed to facilitate clear in-vehicle communication between driver and passenger(s).
- Expandable to 4 people.
- Includes music port for enjoying your favorite tunes.
- Seamless integration with in-dash switch panel.
- May be synched with the Rugged Radios Car-to-Car System (715003440).

ELECTRONIC ACCESSORIES

Rear View Mirror & Camera Monitor	Defender, Defender MAX	715004905
--	------------------------	------------------



- Fully waterproof rear view camera and monitor kit.
- Multiple camera feeds can be seen with the rear view camera, to see what you need.
- Unit replaces stock rear view mirror (screen is integrated in the unit's replacement rear view mirror).
- Camera uses infrared light for night vision capabilities.

Back-Up Monitor and Camera Kit	Defender, Defender MAX	715003834
---------------------------------------	------------------------	------------------



- Fully waterproof rear view camera and monitor kit.
- The camera is one of the clearest and sharpest available on the market, with 250,000 pixel image resolution and a 2.1 mm lens with 130° viewing angle.
- Features 18 infrared lights that allow up to 50 ft. (15.24 m) visibility in complete darkness, an auto iris sensor that adapts to light intensity changes and an adjustable sunshade.
- 7" (17.78 cm) digital TFT LCD colour monitor comes with power harness and can support up to two camera inputs.
- The camera can be roof mounted to monitor your cargo load or to see farther behind, and it can be mounted under the cargo box for hitching purpose.
- Not compatible with Defrost Heat and Ventilation System or HVAC.

Canadian Map for Garmin Montana 680t GPS <small>(Not illustrated)</small>	Defender, Defender MAX	710005065
---	------------------------	------------------

- Additional and readily programmable Canadian basemap for Garmin Montana 680T GPS system.
- Requires Garmin Montana 680T GPS.

Power Tilt Bed	Defender (except 6x6), Defender MAX (2020 & up)	715007096
	Defender 6x6	715007204



- Powerful cargo box tilter with dash-integrated switch.
- Electrical actuated hydraulics for a strong and quick tilting system.

Battery Charger/Maintainer

715005061



- Keeps stored lead-acid batteries charged.
- Charges and maintains small batteries.
- Microprocessor controlled multi-stage charging for added precision, safety and battery life.
- Automatically detects 6 or 12 volt batteries.
- Reverse hook-up protection helps protect battery and charger from damage.
- Auto-voltage detection.
- Press the display button to show the charge progress.
- Content: 3 amp battery charger, clamp adapter, DC adapter, 24" (61 cm) fused ring leads harness with weather cap, owner's manual.
- Not EC compliant.

Jump Starter

715005062



- IPX3 water-resistant and enclosed output ports.
- 4 LED battery indicators for easy read on battery charge level.
- Compact design, will conveniently fit in your backpack, glove box or any other storage compartment.
- 2.4A + 1A/5V USB ports for fast charging of all USB devices.
- Smart cable provides protection against reverse polarity, short circuit, low voltage, high temperature and reverse charging.
- Built-in LED light (3 modes).
- Content: 300CA jump starter, SA858 smart cable clamp, MC-USB to USB charging cable, travel bag, user manual.
- Not EC compliant.

Quick Connect Battery Cable

715005408



- Quickly and easily connect and charge different batteries with your charger.
- Included in the Battery Charger/Maintainer.
- Sold individually.

Quick Connect Cable with Battery Indicator

715006055



- Quickly and easily connect and charge different batteries with your charger.
- 3-colour LED indicator provides constant battery health indication.
- Sold individually.

3-Mode Switch

Defender, Defender MAX

715004445



- Switches quickly and conveniently between normal/work/eco modes.
- Work mode: Reduced throttle sensitivity for smoother acceleration and reduced load impact.
- Eco mode: Increased fuel economy.
- In-dash plug-and-play mount.
- Standard on 2020 models.

RAM GPS Mount

715003325



- Allows for GPS integration onto vehicle.
- Standard AMPS hole pattern for Garmin Cradle.

Digitally Encoded Security System (DESS™) Keys

Defender, Defender MAX

715002458



- Top-security anti-theft protection for your vehicle.
- Encrypted chip technology restricts access to your vehicle's electronic ignition system.
- One vehicle/one code.
- A vibration/shock-resistant ball-and-socket design that ensures a reliable connection.
- 3 programmable modes:
 - Work mode: Limits vehicle speed to 40 kph (25 mph) but does not limit engine torque.
 - Normal mode: Limits vehicle speed to 70 kph (44 mph) and 50% torque reduction.
 - Performance mode: No restrictions.

Auxiliary Battery Installation Kit	Defender, Defender MAX (2019 & prior)	715003758
	Defender, Defender MAX (2020 & up)	715006035



- Allows you to add a second 30Ah battery for that dual battery setup that will give you the extra juice you'll need to power auxiliary electrical components like a sound system or winch.
- Additional battery sold separately (515176151).
- Equipped with an integrated smart battery isolator that will prevent your auxiliary electrical components from draining your starting battery.
- Kit includes an additional battery junction block, all necessary wiring and the battery holder.

USB Power Outlet Kit	Defender, Defender MAX (2020 & up)	219400510
-----------------------------	------------------------------------	------------------



- Recharges your electronic devices while riding* (smartphone, MP3, heating gear, etc.).
 - Dual port USB connectors.
- *The power outlet is not capable of recharging all device types while riding.*

Defrost, Heat & Ventilation System	Defender, Defender MAX 2019 & prior (not compatible with HD5 Motorization)	715004917
	Defender, Defender MAX 2020 (except Defender PRO & HD5 models)	715005904



- Best integrated system on the market with 3-ventilation speed and in-dash adjustable temperature.
- Adjustable/directional vents.
- 10 vents specially positioned for better windshield and side windows defrosting/deicing, foot and hand heat.
- Easy-service air filter.
- Once installed, you might want to add storage space with the Lower Dashboard for Heating System and Dash Storage Compartment Net for Heating System.

Defender, Defender MAX (2021 & up)	715008093
------------------------------------	------------------

- Best integrated in-dash system on the market with 3 fan speeds and adjustable temperature.
- Adjustable/directional vents can be closed to concentrate heat at specific areas.
- A total of 8 vents specially positioned for windshield and occupant heating.
- Easy-to-service air filter.
- Includes the replacement lower dashboard compartment for the heating system.
- Dash Storage Compartment Net for Heating System is recommended.

Heated Steering Wheel	Defender, Defender MAX	715003837
------------------------------	------------------------	------------------



- Ruggedly constructed steering wheel designed to withstand cold conditions while channeling heat directly to your hands.
- Perfect for making hand mobility and grip readily available, e.g., hunting, manual farming.
- Replaces stock steering wheel.
- This kit includes the heated steering and in-dash switch.
- Draws a maximum of 45W and 3.2A at 13.5V.
- Heated Accessory Electrical Harness (710005757) is required on all models except XT cab 2020 & up and PRO models, which require Heated Accessories Wiring Harness (715006036).

Radiator Winter Front	Defender, Defender MAX (2019 and prior)	715005108
------------------------------	---	------------------



- Allows you to get higher heating temperature out of the Defrost, Heat & Ventilation System in extremely cold conditions.

Heated Grab Bar Cover	Defender, Defender MAX	715003835
------------------------------	------------------------	------------------

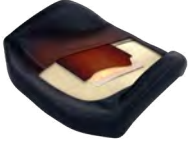

- Made tough to hold up to the stresses of rough riding, this heated cover will keep your passenger's hands warm and securely gripped during long cold outings.
- Easy to install and remove.
- This kit includes the heated grab bar cover and in-dash switch.
- Heated Accessory Electrical Harness (710005757) is required on all models except XT cab 2020 and PRO models, which require Heated Accessories Wiring Harness (715006036).

Heated Seat	Defender, Defender MAX	715006112
	<ul style="list-style-type: none"> • 25W seat heater delivers chill-free riding comfort. • High/low temperature settings allow you to control the desired degree of warmth. • This kit includes one carbon fiber seat heater, foam sheet and in-dash switch. • Installs directly in the original seat cushion. 	<ul style="list-style-type: none"> • Heated Accessories Wiring Harness (710005757) is required for installation on front seat. • Heated Accessories Wiring Harness (715006036) is required for installation on Defender XT Cab, PRO and Limited models. • Heated Accessories Wiring Harness (715006004) is required for installation on rear seats on MAX models.

Heated Seat Harness for MAX Model <i>(Not illustrated)</i>	Defender MAX	715006004
<ul style="list-style-type: none"> • Electric harness required to hook up and operate rear heated seats. 		

Heated Visor Outlet	Defender, Defender MAX	715001246
	<ul style="list-style-type: none"> • Strategically positioned on vehicle to maintain your agility. • Optional visor outlet that delivers fog-free riding. • Quick and easy installation. • Sold individually. • Heated Visor not included. 	

Heated Accessories Wiring Harness <i>(Not illustrated)</i>	Defender, Defender MAX (Models with defrost, heat & ventilation system), All Defender PRO models	715006036
	Defender, Defender MAX (Models without defrost, heat & ventilation system)	710005757
<ul style="list-style-type: none"> • Electric harness required to hook up and operate heated accessories. • Power up to 4 accessories: 2 hand accessories (grab bar/steering wheel) and 2 seat covers. 		

WINCHES & HITCHES

Can-Am HD Winches

Can-Am HD 4500 Winch	Defender, Defender MAX	715006416
	<ul style="list-style-type: none"> • Ergonomic clutch handle. • Rugged all-steel gears and bushings for more torque and durability. • Automatic 100% load-holding brake. • Sealed solenoid for all-weather protection. • Weather sealed corded remote and dash mounted switch. • EC compliant. 	<ul style="list-style-type: none"> • Pulling strength capability of 4,500 lb (2,041 kg). • 43' of 1/8" (13.1 m of 6.3 mm) wire steel cable. • Heavy-duty 4-way roller fairlead. • Winch Electrical Harness (715007078) is required for installation on a Defender 2021 and prior. Winch Electrical Harness (715008152) is required for installation on a Defender Base and DPS 2022 & up.

Can-Am HD 4500-S Winch	Defender, Defender MAX	715006417
	<ul style="list-style-type: none"> • Ergonomic clutch handle. • Rugged all-steel gears and bushings for more torque and durability. • Automatic 100% load-holding brake. • Sealed solenoid for all-weather protection. • Weather sealed corded remote and dash mounted switch. 	<ul style="list-style-type: none"> • Pulling strength capability of 4,500 lb (2,041 kg). • 50' of 3/4" (15.2 m of 6.35 mm) synthetic rope. • Corrosion-proof aluminum hawse fairlead. • Winch Electrical Harness (715007078) is required for installation on a Defender 2021 and prior. Winch Electrical Harness (715008152) is required for installation on a Defender Base and DPS 2022 & up.

WARN[†] VRX Winches

WARN VRX 45 Winch

Defender, Defender MAX
(except XT Cab 2018-2019, Lone Star Edition, X mr, Limited,
DPS Cab & Hunting Edition 2020 & up)

715006110



- Extreme IP68-rated waterproof sealing keeps the elements out.
- Durable all-metal construction.
- Black powder-coated finish and stainless steel fasteners for corrosion resistance.
- Robust new clutch design based on 70+ years of WARN 4 WD hub lock know-how.
- Load-holding brake for great control.
- Smooth and reliable all-metal three-stage planetary gear train.
- Dash-mounted rocker control.
- Limited lifetime warranty (mechanical), 3-year warranty (electrical).
- Pulling strength capability of 4,500 lb (2,041 kg).
- 50' of ¼" (15 m of 6.3 mm) wire steel cable.
- Roller fairlead.
- Winch Electrical Harness (715007078) is required for installation on a Defender 2021 and prior. Winch Electrical Harness (715008152) is required for installation on a Defender 2022 & up.

WARN VRX 45-S Winch

Defender, Defender MAX
(except XT Cab 2018-2019, Lone Star Edition, X mr, Limited,
DPS Cab & Hunting Edition 2020 & up)

715006111



- Extreme IP68-rated waterproof sealing keeps the elements out.
- Durable all-metal construction.
- Black powder-coated finish and stainless steel fasteners for corrosion resistance.
- Robust new clutch design based on 70+ years of WARN 4 WD hub lock know-how.
- Load-holding brake for great control.
- Smooth and reliable all-metal three-stage planetary gear train.
- Dash-mounted rocker control.
- Limited lifetime warranty (mechanical), 3-year warranty (electrical).
- Pulling strength capability of 4,500 lb (2,041 kg).
- 50' of ¼" (15 m of 6.3 mm) synthetic rope.
- Cast aluminum hawse fairlead.
- Winch Electrical Harness (715007078) is required for installation on a Defender 2021 and prior. Winch Electrical Harness (715008152) is required for installation on a Defender 2022 & up.

Cargo Bed Winch

Defender, Defender MAX

715006355



- Allows you to pull heavy loads into the cargo box easily.
- Perfect for hunting applications, i.e., loading game.
- Includes support base made of heavy-duty 2" (5 cm) steel tubing, winch and weather-sealed corded remote.
- 750 lb (340 kg) maximum pulling capacity.
- Electronic security module to prevent vehicle damage that could occur if loaded vehicle exceeds manufacturer's gross weight rating.
- Adapter Kit (715004709) required for installation with Gear Rail Adapter.
- Requires Powertilt bed for Defender 6x6 and PRO.
- Not EC compliant.

Synthetic Winch Cable*

With WARN winch

715007783



- 50' of ¼" (15.2 m of 6.35 mm) synthetic cable for WARN winch.
- WARN Hawse Fairlead is required when upgrading to a synthetic cable to avoid damage and premature wear of the cable.

**Ask your dealer or visit canamoffroad.com for price details.*

Synthetic Winch Cable*

With Can-Am HD winch

715006430



- 50' of ¼" (15.2 m of 6.35 mm) synthetic cable for Can-Am HD winches.
- Hawse Fairlead (715006426) required when upgrading to a synthetic cable to avoid premature cable damage and wear.

**Ask your dealer or visit canamoffroad.com for price details.*

Synthetic Cable Extension

715001120



- Lightweight ¼" (6.35 mm) diameter, easy to handle and won't rattle in cargo box.
- Easily attaches to winch cable to provide additional 50' (15.2 m) of distance.
- 4,500 lb (2,041 kg) single line capacity.

Replacement Wire Rope*	With WARN winch	715006699
	<ul style="list-style-type: none"> • 55' of ¼" (16.8 m of 6.35 mm) wire rope for WARN winch kit. • 4,500 lb (2,041 kg) pulling strength. <p><i>*Ask your dealer or visit canamoffroad.com for price details.</i></p>	
Replacement Wire Rope*	With Can-Am HD winch	705014978
	<ul style="list-style-type: none"> • 43' of ⅝" (13.1 m of 6.3 mm) wire rope. • 4,500 lb (2,041 kg) pulling strength. <p><i>*Ask your dealer or visit canamoffroad.com for price details.</i></p>	
WARN Hawse Fairlead*	With WARN winch	715007785
	<ul style="list-style-type: none"> • Double-powder-coated construction. • Required to use the Synthetic Winch Cable (715007783) on WARN winches. • To be used with synthetic winch cables only. 	
Can-Am HD Hawse Fairlead	With Can-Am HD winch	715006426
	<ul style="list-style-type: none"> • A must when upgrading your winch with a synthetic cable, this corrosion-proof aluminum hawse fairlead will prevent the cable from snapping in a corner of a roller fairlead and from wearing prematurely due to the rough surface of the worn roller guide. • Must be used with synthetic cables only. 	
Roller Fairlead	With Can-Am HD winch	710007082
	<ul style="list-style-type: none"> • Suggested when changing the wire rope. • Heavy-duty replacement fairlead for winches. 	
Multimount Winch Harness <i>(Not illustrated)</i>	Defender MAX, Defender 6x6	710005082
<ul style="list-style-type: none"> • Converts Removable Winch Mounting Kit into a practical multimount winch kit. 		
Wired Remote Control	With Can-Am HD winch	715006504
	<ul style="list-style-type: none"> • This kit allows winch owners to add the hand-held remote to vehicles with a stock winch. • Works in conjunction with the mini-rocker switch. • Remote control and connection socket are included with Can-Am HD winch. • EC compliant. 	
Wireless Remote Control	With WARN winch (Defender 2019 & prior)	715002542
	<ul style="list-style-type: none"> • The system is quick and easy to install, thanks to a wiring harness with an integrated antenna and all necessary mounting hardware. • Allows you to operate your winch from anywhere within a 50' (15.2 m) radius, increasing your recovery options. • All components are weatherproof. 	
Drop Tow Bar	Defender, Defender MAX	715002521
	<ul style="list-style-type: none"> • Sturdy 2" (5 cm) ball-less tow bar. • Conveniently set at standard trailering height. • Requires Higher Front Receiver Hitch (715003109). 	

Removable Winch Mounting Kit	Defender, Defender MAX (except Limited models)	715001652
-------------------------------------	--	------------------



- Allows you to remove your winch when needed.
- Use in combination with the Multimount Winch Harness to quickly and conveniently relocate a front-mounted winch to the rear of the vehicle.
- Not compatible for use with the Lower Front Receiver Hitch.
- Requires Higher Front Receiver Hitch (715003109).

Lower Front Receiver Hitch	Defender, Defender MAX	715002519
-----------------------------------	------------------------	------------------



- Heavy-duty 1,500 lb (680 kg) towing capacity 2" (5 cm) receiver hitch.
- Expand and enhance functionality by pairing it with Higher Front Receiver Hitch and Removable Winch Mounting Kit (need to relocate winch from its standard mounting position).

Higher Front Receiver Hitch	Defender, Defender MAX (except Limited models)	715003109
------------------------------------	--	------------------



- Heavy-duty 1,500 lb (680 kg) towing capacity 2" (5 cm) receiver hitch.
- No need to relocate winch from its standard mounting position.

Winch Electrical Harness <i>(Not illustrated)</i>	Defender, Defender MAX (2019 & prior)	715003093
	Defender, Defender MAX (2020 & 2021)	715007078
	Defender, Defender MAX 2022	715008152

- Required to install a winch on a Defender without a factory-installed winch.

Front and Rear Hitch Drawbar	Defender, Defender MAX	715008350
-------------------------------------	------------------------	------------------



- Standard on 2" (5 cm) receiver hitch.
- It offers 1,650 lb (750 kg) of towing capacity.
- Hitch ball not included.
- Forged steel.

Rubber Receiver Plug		705204503
-----------------------------	--	------------------



- Rubber cap for 2" (5 cm) Receiver Hitch.

SEATS

Central Headrest	Defender, Defender MAX	715005163
-------------------------	------------------------	------------------

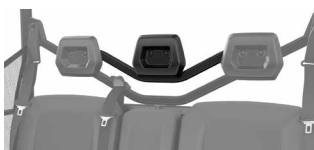

- Headrest for front-center-seating position on 3-seated models and for rear-center-seating position on MAX models.
- Front Headrests are available separately for front passengers on MAX models.
- Headrests are required for all passengers on some regulated trails.
- Not EC compliant.

Headrests are required for all passengers on some regulated trails.

Front Headrests	Defender MAX	715005164
------------------------	--------------	------------------

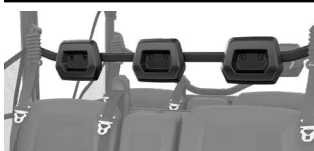

- Additional headrest for all three front-seating positions on MAX models.
- Central Headrest is available separately for rear-center-seating positions on MAX models.
- Headrests are required for all passengers on some regulated trails.
- Not EC compliant.

Headrests are required for all passengers on some regulated trails.

PERFORMANCE

S3 Front High Clearance A-Arm

Contact your authorized dealer or visit our online store at can-amoffroad.com

■ **715003784** · Black



- Prevents A-Arm damage over rough terrain.
- Preserves factory ride quality and turning radius without reducing performance.
- Not compatible with Apache 360 LT Track System and Front A-Arm Protectors.
- "S3 for Can-Am" branded.

S3 Rear High Clearance A-Arm

Contact your authorized dealer or visit our online store at can-amoffroad.com

■ **715003785** · Black
 ■ **715005118**
 • Sunburst Yellow



- Prevents A-Arm damage over rough terrain.
- Preserves factory ride quality and turning radius without reducing performance.
- Not compatible with Apache 360 LT Track System and Rear A-Arm Protectors.
- "S3 for Can-Am" branded.

Brake Holding Mechanism

Defender, Defender MAX

715004733



- Maintains constant pressure on the brake pedal to keep the vehicle from moving on sloped terrain, without having to put the transmission in P (park).

Heavy-Duty Spring Kit

Defender (2019 & prior), Defender HD8 (2020 & up),
 Defender (select 2022 models)

715005084



- This set of heavy-duty springs will stiffen your suspension.
- Perfect for reducing vehicle overall sag when shocks are under heavy demand: heavy loading and hauling or for snow clearing.
- Complete kit of 4 springs.
- Not compatible with Defender HD5, XT CAB, Mossy Oak Edition & X mr models and Defender MAX.

850 W Magneto Kit

Defender, Defender MAX (2020 & up except HD5 & HD7)

715007122



- Increases the magneto output to 850 W.
- Includes rotor, stator and regulator.

Emergency Kit

Defender, Defender MAX

715006102



- Complete emergency kit provides all essential equipment and supplies to get out of most unfavorable situations powersport enthusiasts can find themselves in.
- Includes: jumper cables, air compressor, tyre repair kit, first aid kit, ratchet tie-down, duct tape, tow strap 3,300 lb (1,500 kg), zip-ties, cloth rags.

Smart-Lok Technology

Smart-Lok Differential	Defender, Defender MAX (2019 & prior)	705402936
-------------------------------	---------------------------------------	------------------



- Can-Am-exclusive Smart-Lok technology constitutes a true full lockable on-the-fly front differential with electronically controlled automatic modes.
- Choose your differential settings according to your riding need: "2x4" for rear wheel traction only, "4x4 Front Diff Lock" for a fully locked 4 wheel drive, and "4x4 Smart Modes" that offer preset, intelligent calibrations for your type of riding.
- Using multiple input sources, "Smart Modes" will instantaneously engage locking with the right load at the right moment to procure maximum traction while retaining low-speed maneuverability, allowing for optimal placement and a feeling of confidence.
- The Smart-Lok Kit comes standard with the Trail Mode.
- Requires Performance Half Shafts (2x) and Front Differential Kit for installation.

Performance Half Shaft	Defender and Defender MAX (2019 & prior –except X mr, XT-P and XT CAB 2018 & up)	705402353
	Defender, Defender MAX XT Cab 2018-2019, Lone Star Edition 2019 & prior	705402575



- High-performance design ideal for off-road use, with superior wheel power and acceleration for racing, dunes and desert riding.
- Includes CVs, shaft and boots with the best suited geometry for your Can-Am vehicle.

Mud Smart Mode Module <i>(Not illustrated)</i>	Models with Smart-Lok Differential	715005282
--	------------------------------------	------------------

- These modules allow you to add the Mud, Rock or Trail Activ Smart Mode to vehicles equipped with the Smart-Lok Differential Kit.
- Designed to deliver superior traction in the deepest mud holes.
- When high engine torque and/or slippage is detected, Smart-Lok will fully lock the front end.
- The system will stay locked until throttle release.
- Only one Smart Mode Module can be installed at a time.

Rock Smart Mode Module <i>(Not illustrated)</i>	Models with Smart-Lok Differential	715005283
---	------------------------------------	------------------

- These modules allow you to add the Mud, Rock or Trail Activ Smart Mode to vehicles equipped with the Smart-Lok Differential Kit.
- Designed to help cross challenging rocks.
- When high engine torque is detected at low vehicle speed, Smart-Lok will progressively lock the front end and will stay engaged until throttle release to prevent wheel slippage and provide optimal traction.
- The progressive engagement allows for easier steering when maneuvering the vehicle.
- Only one Smart Mode Module can be installed at a time.

Trail Activ Smart Mode Module <i>(Not illustrated)</i>	Models with Smart-Lok Differential	715005284
--	------------------------------------	------------------

- These modules allow you to add the Mud, Rock or Trail Activ Smart Mode to vehicles equipped with the Smart-Lok Differential Kit.
- Designed for aggressive riding delivering the ultimate cornering precision.
- When high engine torque and/or an increase in vehicle speed is detected, Smart-Lok will progressively engage the front end and maintain it engaged until throttle release or vehicle speed reduction.
- The progressive engagement allows for lower smooth steering effort.
- Only one Smart Mode Module can be installed at a time.

Air Intakes & Exhaust

Snorkel Kit

Defender, Defender MAX (except Defender HD5, HD7 and Defender PRO)

715003727



- Raises point of engine and CVT air intakes so vehicle can be semi-submersed in water/mud without taking in water to the engine.
- Not compatible with Headache Racks, Gear Rail equipment, DragonFire Cargo Bed Roll Bar and Windshield Wiper & Washer Kit.
- Snorkel Extension Kit is available for roof level air intake and CVT exhaust.
- Adapter for Snorkel Kit (715004414) and Sealed Air Box (707801033) are required for installation on 2017 and prior models.
- Standard on Defender X mr models.

Snorkel Extensions

Defender, Defender MAX

715004415



- Extend the Snorkel Kit for roof engine and CVT air intake.
- Add aggressive look to your vehicle and help keep your intakes clear from mud, snow, dust, etc. in severe riding conditions.
- Not compatible with all rear panels and windows, Rear Cargo Light and roof-mounted Rear View Camera.
- Snorkel Kit (715003727) is required, except for X mr models.

Adapter for Snorkel Kit

(Not illustrated)

Defender and Defender MAX 2017 & prior

715004414

- Required for the installation of Snorkel Kit (715003727) on Defender 2017 and prior models.
- Includes rear firewall for Snorkel Kit and hardware.
- Standard on Defender 2018 & up models.

Sealed Air Box

(Not illustrated)

Defender, Defender MAX 2017 & prior

707801033

- Required when installing the Snorkel Kit (715003727) on Defender and Defender MAX 2017 and prior models.
- Standard on Defender 2018 & up models.

Snorkel Pre-FILTER

Defender, Defender MAX (except Defender PRO)

715005597



- Pre-filter specifically for snorkels.
- Adds extra protection to your engine in harsh riding conditions.
- Helps keep air filter cleaner.
- Filter blocks particles larger than 0.005" (0.13 mm).
- Necessary to maintain vehicle warranty when tracks are installed.
- For Defender MY20 & up: Use only one of 2 pre-filter for engine intake and combine with kit 715008651 for the CVT inlet.

Air Intake Pre-Filter

Defender (except X mr models), Defender MAX

715003483



- Adds extra protection to your engine in harsh riding conditions.
- Helps keep air filter cleaner.
- Filter blocks particles larger than 0.007" (0.19 mm).
- Easy, tool-less installation.
- Necessary to maintain vehicle warranty when tracks are installed.
- Required to install the Apache and Backcountry Track Systems.
- Not compatible with Snorkel Kit.

Foam Air Filter by Twin AIR†

Defender, Defender MAX

715003630



- The best choice for the harshest conditions.
- Multiple staged oiled filtering foam for superior dust retaining capacity with high air flow.
- Washable and reusable.

CVT Air Intake Relocation Kit

Defender, Defender MAX (except X mr, HD5 & PRO models)

715004183

Defender, Defender MAX 2020 & up (except HD5)

715008651



- Relocates the CVT air intake protected in the cab area.
- Keeps the CVT air intake away from snow splashing from wheels or tracks.
- Mandatory for track equipped 2020 & up Defender models HD10 and highly recommend for others models.
- Not compatible with Snorkel Kit.

APACHE TRACK SYSTEMS

Winter Tracks

Apache BackCountry LT Track Kit

Defender, Defender MAX (except 6x6)

715005891



- Tracks designed to deliver the best snow performance on the market with unmatched flotation level and traction on snow surface.
- Large contact patch, 37% bigger than the Apache 360 LT.
- Impressive added ground clearance of 6.4" (16 cm) helps keep the vehicle over the snow.
- Lightweight snowmobile-inspired rail design.
- Aggressive track design with 2" (5 cm) lug height for maximum traction on snow.
- Apache Backcountry LT Mounting Kit, Track DPS Module and Engine & CVT Pre-Filter are required.
- Fine-tune your track system using extra Idler Wheels, Sliders with Vespel Inserts and Rail Ice Scratcher.
- For winter use only.

Apache Backcountry LT Mount Kit

(Not illustrated)

See table for fit, compatibility and requirements.

715005888

715005493

715006196

- Required for installation of the Apache Backcountry LT Track System.
- DPS module and engine pre-filter are required and sold separately.
- The CVT air intake relocation kit is MANDATORY for track-equipped 2020 & up Defender models HD10 and highly recommended for other models. This kit is sold separately.

Rail Ice Scratchers

Apache Backcountry and Backcountry LT Track Systems

860201728



- Provide additional lubrication in hard and icy conditions and extend slider life.
- Rail mounted, small, light.
- Design expands on coil concept to allow reversing without damage.
- Easily stored when not in use.

Extra Wheel Kit

Apache Backcountry LT Wheel kit

715006293



- Additional wheel kit for Backcountry LT rear tracks.
- Reduces drag and rolling resistance in hard snow conditions or when transporting heavier loads.
- Extends slider life in hard snow conditions.
- Includes two wheels, cross shaft and mounting hardware per kit to service one track corner.
- Up to two kits per rear track can be installed.

Apache Backcountry LT Tracks Fitting Guide

Model Year / Model	Length	Track	Track Mount	Track DPS Module	Prefilter without Snorkel	Prefilter with Snorkel
2019 & Prior Defender Base, DPS, XT, XT Cab 2017 & Hunting Edition, XT-P	62"	715005891	715005888	715007338	715003483 & 715004183 (except X mr)	715005597
2019 & Prior Defender XT Cab 2018-2019, Lone Star Edition & X mr	67"		715006196			
2020 & Up Defender Base, DPS (HD5, HD7, HD8 & HD9), XT (HD8 & HD9)	62"		715005888			
2020 & Up Defender DPS (HD10), XT (HD10), XT-P, PRO DPS, PRO XT	64"		715005493			
2020 to 2022 Defender XT Cab, XT Cab Limited, Hunting Edition, Lone Star Edition, X mr, PRO Limited, PRO Lone Star	67"		715006196			
2023 Defender XT Cab, XT Cab Limited, Hunting Edition, Lone Star Edition, X mr, PRO Limited, PRO Lone Star	67"		715005493			

Year-Round Tracks

Apache 360 LT Track System

Defender, Defender MAX (except 6x6)

715005103



- Multifunctional tracks designed to support heavy loads and to fit on most Can-Am Off-Road vehicles.
- Extra contact patch adjustment for better performance over rough terrain.
- Contact patch is 7 to 9% bigger than the Apache 360's.
- Average ground clearance increase of 4.5" (11.44 cm). 1" (2.5 cm) lugs in the front and 1.25" (3.2 cm) in the back.
- Apache 360 LT Mounting Kit is required.
- EC compliant.

Apache 360 LT Mounting Kit

(Not illustrated)

See table for fit, compatibility and requirements.

715004832

715004831

715005492

- Required to install Apache 360 LT Track System.
- DPS module and engine pre-filter are required and sold separately.
- The CVT air intake relocation kit is MANDATORY for track-equipped 2020 & up Defender models HD10 and highly recommended for other models. This kit is sold separately.

Track DPS Module

(Not illustrated)

715007338

- An innovative DPS module that ensures speedometer accuracy and optimized steering assist, which make for perfect track control and riding ease.
- Required to install the Apache and Backcountry Track Systems.

Apache 360 LT Tracks Fitting Guide

Model Year / Model	Length	Track	Track Mount	Track DPS Module	Prefilter without Snorkel	Prefilter with Snorkel
2019 & Prior Defender Base, DPS, XT, XT Cab 2017 & Hunting Edition, XT-P	62"	715005103	715004831	715007338	715003483 & 715004183 (except X mr)	715005597
2019 & Prior Defender XT Cab 2018-2019, Lone Star Edition & X mr	64"		715004832			
2020 & Up Defender Base, DPS (HD5, HD7, HD8 & HD9), XT (HD8 & HD9)	62"		715004831			
2020 & Up Defender DPS (HD10), XT (HD10), XT-P, PRO DPS, PRO XT	64"		715005492			
2020 to 2022 Defender XT Cab, XT Cab Limited, Hunting Edition, Lone Star Edition, X mr, PRO Limited, PRO Lone Star	67"		715004832			
2023 Defender XT Cab, XT Cab Limited, Hunting Edition, Lone Star Edition, X mr, PRO Limited, PRO Lone Star	67"		715005492			

PROMOUNT PLOWS

Can-Am ProMount Flex2 Plow kit

Can-Am ProMount Flex2 72" (183 cm) Blade Plow Kit

Defender, Defender MAX

715008170



- These kits include:
 - Can-Am ProMount Flex2 Blade
 - Push Frame with Quick-Attach System
 - Mounting plate

Can-Am ProMount Flex2 Blades

Can-Am ProMount Flex2 66" (168 cm) Blade

Fits ProMount Push Frame

715006265



- Plow blade made of UHMWPE, flexible and impact absorbing material prevents damaging your plow when accidental impact occurs.
- Replaceable wear blade.
- Large pin designed for easy blade rotation to eliminate snow buildup at pivot point.
- Blade design provides best snow roll-off at any angle.
- Clears 60" (152 cm) when plow is fully angled.
- Blade height of 17" (43 cm).
- Compatible with Can-Am ProMount Blade accessories to further enhance plow versatility.

Can-Am ProMount Flex2 72" (183 cm) Blade

Fits ProMount Push Frame

715004485



- Plow blade made of UHMWPE, flexible and impact absorbing material prevents damaging your plow when accidental impact occurs.
- Replaceable wear blade.
- Large pin designed for easy blade rotation to eliminate snow buildup at pivot point.
- Blade design provides best snow roll-off at any angle.
- Clears 66" (168 cm) when plow is fully angled.
- Blade height of 17" (43 cm).
- Compatible with Can-Am ProMount Blade accessories to further enhance plow versatility.

Can-Am ProMount Steel Plow Kit

Can-Am ProMount Steel 72" (183 cm) Blade Plow kit

Defender, Defender MAX

■ 715008172 · Black
■ 715008171 · Yellow



- These kits include:
 - Can-Am ProMount Steel Blade
 - Push Frame with Quick-Attach System
 - Mounting plate

Can-Am ProMount Steel Blades

Can-Am ProMount Steel 66" (168 cm) Blade

Fits ProMount Push Frame

■ 715006337 · Black
■ 715006338 · Yellow



- Plow blade made from 12-gauge steel.
- Replaceable wear blade.
- Large pin designed for easy blade rotation to eliminate snow buildup at pivot point.
- Blade design provides best snow roll-off at any angle.
- Clears 60" (152 cm) when plow is fully angled.
- Blade height of 17" (43 cm).
- Compatible with Can-Am ProMount Blade accessories to further enhance plow versatility.
- Not compatible with S3 High Clearance Front A-Arm.

Can-Am ProMount Steel 72" (183 cm) Blade

Fits ProMount Push Frame

■ 715004474 · Black
■ 715006021 · Yellow



- Plow blade made from 12-gauge steel.
- Replaceable wear blade.
- Large pin designed for easy blade rotation to eliminate snow buildup at pivot point.
- Blade design provides best snow roll-off at any angle.
- Clears 66" (168 cm) when plow is fully angled.
- Blade height of 17" (43 cm).
- Compatible with Can-Am ProMount Blade accessories to further enhance plow versatility.
- Not compatible with S3 High Clearance Front A-Arm.

ProMount Plow Kits - Reference Charts

	66" Black Steel	66" Yellow Steel	66" Flex2	72" Black Steel	72" Yellow Steel	72" Flex2
Plow Kit	-	-	-	715008172	715008171	715008170
Blade	715006337	715006338	715006265	715004474	715006021	715004485
Push Frame	715008116	715008116	715008116	715008116	715008116	715008116
Mounting Plate	715007745	715007745	715007745	715007745	715007745	715007745

Can-Am ProMount Angle Plows

Can-Am ProMount 66" (168 cm) Steel Oneway State Blade

Fits ProMount Push Frame

715007263



- Make the job easier with the right tools, clear long alleys and make the task easier by sending the snow further out of the way.
- Wing end of plow measures 26" (67 cm) high and tapers down to 16" (41 cm).
- One-way "winged" state plow designed to throw snow higher.
- Rubber flap (715007299) designed to keep snow away from the driver is offered as accessory (sold separately).
- Can-Am branded.

Can-Am ProMount 72" (183 cm) Steel Oneway State Blade

Fits ProMount Push Frame

715007264



- Make the job easier with the right tools, clear long alleys and make the task easier by sending the snow further out of the way.
- Wing end of plow measures 26" (67 cm) high and tapers down to 16" (41 cm).
- One-way "winged" state plow designed to throw snow higher.
- Rubber flap (715007299) designed to keep snow away from the driver is offered as accessory (sold separately).
- Can-Am branded.

Can-Am ProMount Plow Accessories

Can-Am ProMount Edge Markers

Defender, Defender MAX

715004206



- Help locate the edges of your plow.
- Height: 24" (60 cm).
- Sold in pairs.
- Compatible with Can-Am ProMount Steel and Flex2 blades with or without Blade Extensions (except for the Can-Am ProMount Steel 54" (137 cm) Blades).

Can-Am ProMount 66" (168 cm) Plastic Wear Blade

Defender, Defender MAX

715004482

Can-Am ProMount 72" (183 cm) Plastic Wear Blade

Defender, Defender MAX

715004483



- To help prevent scratches on smooth driveways and markable surfaces.

Can-Am ProMount Drift Cutters

Defender, Defender MAX

715006258



- Help keep snow in the plow.
- Dimensions: 17" x 13" (43.2 cm x 33 cm).
- Sold in pairs.
- Compatible with Can-Am ProMount Steel and Flex2 blades with or without Blade Extensions (except for the Can-Am ProMount Steel 54" (137 cm) Blades).





Can-Am ProMount Blade Extensions

Defender, Defender MAX

■ 715004205 · Black
■ 715005319 · Yellow

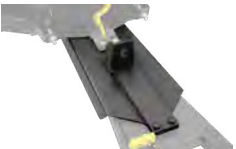

- Add 3" (8 cm) each side.
- Compatible with Can-Am ProMount Blades (except for Can-Am ProMount Steel 54" [137 cm] Blade).
- Longer Wear Blade can be installed to further extend the extra length already provided by the extensions.
- Compatible with Can-Am ProMount Steel and Flex2 Blades (except for the Can-Am ProMount Steel 54" [137 cm] Blades).

Back Drag Blade <i>(Not illustrated)</i>	ProMount Plows (60" and more)	715007794
<ul style="list-style-type: none"> ▪ ¼ thick steel swivel scraper. ▪ Lifts up when the vehicle is moving forward so as not to affect the scraping. ▪ Increased capacity to pull snow. ▪ More aggressive scraping in reverse mode. ▪ Lifts the scraper off the ground so that it scrapes evenly. ▪ Adjustable in length for compatibility with 60", 66" and 72" blades. ▪ Compatible with ProMount blades (Flex and Steel). 		
Can-Am ProMount Push Frame with Quick-Attach System	Defender, Defender MAX	715008116
	<ul style="list-style-type: none"> ▪ Heavy-duty steel tubes designed to withstand the roughest use. ▪ Mid-mount carriage provides ultimate push strength and traction. ▪ Designed for maximum plow lift height. ▪ Features a self-aligning quick-attach system, an easy foot release pedal and an ergonomic handle for plow angle adjustment. ▪ Plow Limit Switch recommended to extend winch cable lifespan. ▪ Can-Am ProMount Mounting Plate required for installation. ▪ Blade swivels left or right, 5 positions. ▪ Large pin designed for easy blade rotation to eliminate dirt and snow buildup at pivot point. 	
Can-Am ProMount Push Frame Extension	Defender, Defender MAX	715006257
	<ul style="list-style-type: none"> ▪ 12" (30 cm) push frame extension required when plow is installed with Apache Track Systems. 	
Can-Am ProMount Mounting Plate	Defender, Defender MAX (2021 & prior)	715007743
	<ul style="list-style-type: none"> ▪ Required to install the Can-Am ProMount Push Frame with Quick-Attach System. ▪ Mounting plate precision-designed to stay on year round without compromising ground clearance. ▪ Comes with the Plow Roller Fairlead. ▪ Not compatible with S3 Front High Clearance A-Arm (715003784). 	
Can-Am ProMount Mounting Plate	Defender, Defender MAX (2022 & up)	715007745
	<ul style="list-style-type: none"> ▪ Required to install the Can-Am ProMount Push Frame with Quick-Attach System. ▪ Mounting plate precision-designed to stay on year round without compromising ground clearance. ▪ Comes with the Plow Roller Fairlead. ▪ Not compatible with S3 Front High Clearance A-Arm (715003784). 	
Plow Angling System*	Defender, Defender MAX	715006022
	<ul style="list-style-type: none"> ▪ Converts your plow system into an easy-to-control unit from the driver's seat. ▪ Allows you to have full up/down and left/right plow control at your fingertips by using the supplied joystick. ▪ Using one hand to control all plow motions will allow you to easily concentrate and manage your plowing tasks. ▪ Push Frame Extension (715006257) is required for installation with the Front Rancher Bumper. ▪ Not compatible with Apache Backcountry Track System. 	
ProMount Plow Limit Switch <i>(Not illustrated)</i>	Defender, Defender MAX	715006259
<ul style="list-style-type: none"> ▪ For controlling the cable tension when over-raising your plow system. ▪ Prevents winch, plow push frame and vehicle damage. ▪ Sensor relocated for optimal lift height. 		
Plow Roller Fairlead	Defender, Defender MAX	715001223
	<ul style="list-style-type: none"> ▪ Cylindrical roller fairlead ▪ Larger diameter lower roller reduces wear on wire rope for plow application. ▪ Can be used with all ProMount plows. 	

Super-Duty Plow System

Super-Duty 72" (183 cm) Blade Plow Kits	Defender, Defender MAX	715003416
--	------------------------	------------------



- A comprehensive plow system with manual lift and angling.
- Ultra-durable 72" (183 cm) blade made of 12-gauge steel with integrated reinforcement and heavy-duty push tubes to tackle the most demanding jobs.
- Requires a winch for raising and lowering.
- Convenient disconnect system for quick and easy installation or removal.
- Front mount provides minimum 11" (28 cm) lift distance.

This kit includes:

- 72" (183 cm) Super-Duty Plow.
- Super-Duty Plow Push Frame.
- Super-Duty Plow Mounting Kit.

Super-Duty Plow Hydraulic Angling Kit	Defender, Defender MAX (2019 & prior)	715002840
	Defender, Defender MAX (2020 & up)	715006038



- Allows you to have full up/down and left/right plow control at your fingertips.
- Pre-assembled, it comes with everything you need to turn your Super-Duty Plow into a quick, easy-to-control unit from the driver's seat.
- Using one hand to control all plow motions with the supplied joystick will allow you to easily concentrate and manage your plowing tasks.
- With this commercial grade kit, you will send snow exactly where you want reliably all winter long.
- Winch and plow sold separately.

Super-Duty Plow Push Frame Extension <i>(Not illustrated)</i>	Super-Duty Plow	715001221
---	-----------------	------------------

- Extension to use the Super-Duty Plow with the Apache 360 LT Track System.
- Comes with Plow Magnetic Switch and Plow Pulley.
- Requires Front Bumper or Front Accessory Bar for installation.

Plow Blade Extensions	Super-Duty Plow	715001217
------------------------------	-----------------	------------------



- Side extensions for widening your plow blade by 6" (15 cm) on each side.
- Include rubber flaps for extension parts.
- Sold in pairs.

Plow Edge Markers <i>(Not illustrated)</i>	Super-Duty Plow	715001216
--	-----------------	------------------

- For a more accurate view of the width of your plow.
- Allows you to work closely around objects.

Plow Drift Cutter <i>(Not illustrated)</i>	Super-Duty Plow	715001218
--	-----------------	------------------

- Keeps snow securely in the plow.
- Allows you to cut a cleaner pass.
- Sold individually.

Plow Rubber Flap <i>(Not illustrated)</i>	Super-Duty Plow	715001219
---	-----------------	------------------

- Keeps snow away from the driver and helps snow to roll in front of the plow.

Plow Pulley <i>(Not illustrated)</i>	Super-Duty Plow	715002042
--	-----------------	------------------

- For use with the Super-Duty Plow.
- Helps winching efficiency.
- Requires Front XT Bumper.

Plow Magnetic Switch <i>(Not illustrated)</i>	Super-Duty Plow	715001995
---	-----------------	------------------

- Magnetic switch that stops the winch to prevent cable, winch and frame damage.
- For use with Super-Duty Plow.

COVERS & ADD-ONS

Trailing Cover

Defender, Defender 6x6, Defender PRO
Defender MAX

715004453

715004454



- Heavy-duty canvas made of UV-resistant solution-dyed polyester.
- Inner soft liner protects windshield and coloured panels from abrasion.
- All high-abrasion areas are reinforced with a double canvas layer.
- Weather-resistant trailable cover protects your vehicle during storage and transportation.
- Opening for fuel cap.
- Quick and easy installation.
- Designed to perfectly fit your vehicle with or without Can-Am accessories.
- Does not fit with Adventure Roof Rack (715003870).

Bolt-On[†] Retractable Ratcheting Tie-Downs

295101072



- Perfect for transporting your powersport vehicle or securing loads.
- Mounts easily: Bolts on any flat surface (e.g., truck bed or frame).
- 1" x 6' (2.5 cm x 1.8 m) tie-down strap with heavy-duty stitching that delivers a 500 lb (226 kg) working load strength and 1,500 lb (680 kg) break strength.
- Convenient retractable push button automatically slackens, spools and stores away strap, while the ratchet mechanism tightens the strap snugly to secure your vehicle or load into place.
- Rubber ratcheting handle provides firm grip, and the hook is vinyl coated to protect whatever surface it hooks into.
- Sold in pairs.

Ratchet Tie-Downs

■ **715008309** · Black/Gray



- 400 lb (181 kg) safe working load.
- 1" x 10' (2.5 cm x 3 m) strap with Sea-Doo, Ski-Doo and Can-Am logos.
- Deluxe ratchet with rubber handle.
- Coated S hooks.
- Pack of 2.

Heavy-Duty Ratchet Tie-Down

715008308



- 1,000 lb (454 kg) safe working load.
- 1.5" x 6' (38 mm x 1.8 m) strap with BRP brands.
- Deluxe ratchet with rubber handle.
- Black-coated clip hooks.
- 12" (300 mm) webbing included.
- Pack of two.

TYRES & RIMS

Tyres

XPS Swamp Force Tyres

Defender X mr, Defender MAX X mr

705403201 · Front

705503387 · Rear



- Front: 30" x 9" x 14"
- Rear: 30" x 11" x 14"

XPS Trac Force

Defender (Limited & Lone Star models)

705403080 · Front

705503354 · Rear



- Front: 30" x 9" x 14"
- Rear: 30" x 10" x 14"
- All-Terrain Light Truck Style Radial tyre
- 8-ply rating offered in 30X9R14
- Central tread for good grip and comfort on compact terrain.
- Tread depth: 18 mm
- Max PSI: 42 front, 44 rear

XPS Trail Force Tyres

Defender MAX HD8, Defender DPS HD8, Defender MAX DPS HD8, Defender XT HD8, Defender MAX XT HD8, Defender DPS CAB HD8, Defender LTD HD10, Defender MAX LTD HD10 (front only)

705402754 · Front

705503103 · Rear



- All-terrain radial tyre.
- 8-ply construction offered in 27X9R14.
- Versatile and suitable for many types of terrain.
- Aggressive tread pattern for better traction on dirt, mud and rocky terrains.
- Tread depth: 20 mm.
- Max PSI: 42.

ITP Cryptid

Defender X mr

705402504 · Front

705502913 · Rear



- Front: 30" x 9" x 14".
- Rear: 30" x 11" x 14".
- Graduated lug height and paddle-like shoulder configuration provide maximum side bite for climbing in and out of the mud without compromising ride comfort on trails and hard pack.
- 6-ply rated.

Maxxis Bighorn 2.0 Tyre



- Front: 27" x 9" x 14".
- Rear: 27" x 11" x 14".

Defender (XT, XT Cab)

705402168 · Front

705400961 · (C€)

705502665 · Rear

705501295 · (C€)

- Front: 27" x 9" x 12".
- Rear: 27" x 11" x 12".

Defender

705402560 · Front

705401386 · (C€)

705502938 · Rear

705501818 · (C€)

- Front: 28" x 9" x 14".
- Rear: 28" x 11" x 14".

Defender

705402080 · Front

705502603 · Rear

Maxxis M923J/M924J

Defender (Base & DPS models only)

705402107 · Front

705502626 · Rear



- Front: 25" x 8" x 12".
- Rear: 25" x 10" x 12".

Rear Tyre Chains

715003839 · 27" x 9"x 14"

715000225 · 29" x 9"x 14"



- Improve your traction in mud and snow.
- Sold in pairs.

Rims

14" Rim

(Not illustrated)

Defender, Defender MAX

705401594 · Front

705503191 · Rear

- Front: 14" x 6.5" offset = 41 mm.
- Rear: 14" x 8" offset = 51 mm.
- Black with clear coat aluminum rim.
- Choice of beadlock colour (not included).
- Needs 16 bolts (250000787) for installing the beadlock.

14" Beadlock Rings

Defender, Defender MAX

705401586 · Manta Green

705401837 · Can-Am Red

705401702 · Octane Blue

705401840 · Black



- Cast aluminum beadlock.
- Must be installed on Front Rim (705401594) and Rear Rim (705503191).

Matching Nuts - 250100184

Matching Cap - 705400928

12" Rim

(Not illustrated)

Defender, Defender MAX

■ 705401678 · Black · Front

■ 705502244 · Black · Rear

- Front: 12" x 6" offset = 41 mm.
- Rear: 12" x 7.5" offset = 51 mm.
- Black with clear coat aluminum rim.
- Choice of beadlock colour (not included).
- Needs 16 bolts (250000787) for installing the beadlock.

12" Beadlock Rings

Defender, Defender MAX

■ 705401816 · Can-Am Red

■ 705401815 · Orange Crush

■ 705401814 · Yellow

■ 705401695 · Octane Blue



- Cast aluminum beadlock.
- Must be installed on Front Rim (705401678) and Rear Rim (705502244).

Matching Nuts - 250100184

Matching Cap - 705400928

Outlander X mr and Defender Rim

Defender, Defender MAX (front wheels)

■ 705401848 · Black and machinged · Front

■ 705401849 · Black · Front

■ 705502397 · Black and machinged · Front

■ 705502398 · Black · Rear



- Cast aluminum rim with trendsetting explosive styling so you can ride—and look—like a trailblazer.
- Front: 14" x 6.5" offset = 10 mm.
- Rear: 14" x 8.5" offset = 23 mm.

Matching Nuts - 250100184 Black, 250100185 Chrome

Matching Cap - 705401541

Defender Cast-Aluminum 14" Rim

Defender, Defender MAX

■ 705402338 · Black · Front

■ 705502778 · Black · Rear



- Front: 14" x 7" offset = 41 mm.
- Rear: 14" x 8.5" offset = 51 mm.

Matching Nuts - 250100184

Matching Cap - 705401541

Lone Star Cast-Aluminum 14" Rim

(Not illustrated)

Defender, Defender MAX

705402334 · Front

705502775 · Rear

- Front: 14" x 7" offset = 41 mm.
- Rear: 14" x 8.5" offset = 51 mm.

Matching Nuts - 250100184

Matching Cap - 705401541

Defender Rim

(Not illustrated)

■ 705402120 · Black · Front

■ 705402118 · Silver and machinged · Front

■ 705402121 · Black and machinged · Front

■ 705502637 · Black · Rear

■ 705502634 · Silver and machinged · Rear

■ 705502635 · Black and machinged · Rear

- Front: 14" x 7" offset = 41 mm.
- Rear: 14" x 8.5" offset = 51 mm.

Matching Nuts - 250100184 Black, 250100185 Chrome

Matching Cap - 705401541



CAN-AM MAVERICK X3

CAN-AM MAVERICK X3

MODEL PACKAGES

Can-Am Maverick X3 X ds Turbo RR	71
Can-Am Maverick X3 X ds Turbo RR Competitive Chart	72
Can-Am Maverick X3 X rs Turbo RR	73
Can-Am Maverick X3 X rc Turbo RR 72"	74
Can-Am Maverick X3 MAX X rs Turbo RR	75

COMPARATIVE CHART

Can-Am Maverick X3 Lineup	76
---------------------------	----

ACCESSORIES

Roofs	78
Soft Cab Enclosure	79
Windshields & Mirrors	79
Doors	81
HMWPE Skid Plates	83
Bumpers & Guards	84
Seat Accessories	87
LinQ: Easy On, Easy Off Cargo	88
Racks & Storage	93
Lights	94
Audio & Communication Systems	98
Electrical & Electronic Accessories	99
Winches & Hitches	101
Performance	103
Trailer	107
Apache Track Systems	108
ProMount Plows	110
Tyres & Rims	113



WHAT'S NEW

Sport Roof & 4-Point Retractive Harness

For Maverick X3 X ds Turbo RR packages

New Premium Colouration

Mineral Gray & Desert Tan:
Can-Am Maverick X3 X rc Turbo RR 72" package

2023 CAN-AM MAVERICK X3 X_{DS} TURBO RR



Triple Black / TURBO RR

PACKAGE HIGHLIGHTS

- 200 hp. turbo charged Rotax powerplant with intercooler
- Smart-Lok front differential
- FOX® 2.5 PODIUM RC2¹ piggyback shocks
- Belt monitoring system
- 850 W magneto
- 7.6 in. digital display with keypad
- X-package graphics/seats
- 4-point harness with shoulder pads
- Can-Am signature LED lights
- 14 in. aluminum beadlock wheels
- Maxxis Carnivore 30 in. tyres
- 64 in. wide with more than half a metre of suspension travel
- Full roof
- HMWPE full skid plate

ENGINE	TURBO RR
Type	200 hp, Rotax® ACE (Advanced Combustion Efficiency) 900 cc turbocharged triple-cylinder engine, liquid-cooled with integrated intercooler, and high-performance air filter
Fuel Delivery System	Intelligent Throttle Control (iTC™) with Electronic Fuel Injection (EFI)
Transmission	pDrive primary and Quick Response System X (QRS-X) CVT with high airflow, L/H/N/R/P
Drive Train	Lockable front differential with exclusive Smart-Lok technology. True 4 modes traction system: 2WD/4WD with front diff. lock/4WD TRAIL ACTIV/4WD TRAIL
Power Steering	High torque Tri-Mode Dynamic Power Steering (DPS™)

SUSPENSIONS

Front Suspension	Double A-arm with sway bar/20 in. (50.8 cm) travel
Front Shocks	FOX 2.5 PODIUM RC2 Piggyback with dual speed compression and rebound adjustments
Rear Suspension	4-link Torsional Trailing-arm X (TTX) with sway bar/20 in. (50.8 cm) travel
Rear Shocks	FOX 2.5 PODIUM RC2 Piggyback with dual speed compression, rebound adjustments and bottom-out control

TYRES & WHEELS

Front Tyres	Maxxis Carnivore ¹ 30 x 10 x 14 in.
Rear Tyres	Maxxis Carnivore ¹ 30 x 10 x 14 in.
Wheels	14 in. cast-aluminum beadlock

BRAKES

Front	Dual 262 mm disc brakes with hydraulic twin-piston calipers
Rear	Dual 248 mm disc brakes with hydraulic twin-piston calipers

DIMENSIONS & CAPACITIES

Estimated Dry Weight	1,554 lb (704.9 kg)
Chassis/Cage	Dual-phase 980 steel
L x W x H	132 x 64 x 65.7 in. (335.3 x 162.5 x 166.9 cm)
Wheelbase	102 in. (259.1 cm)
Ground Clearance	14 in. (35.6 cm)
Rack Capacity	200 lb (91 kg) with LinQ® Quick-Attach
Storage Capacity	Total: 2.5 gal (9.4 L)
Fuel Capacity	10.5 gal (40 L)
Person Capacity	2

FEATURES

Gauge	7.6 in. wide digital display with keypad
Instrumentation	DC outlet (10-A)
Anti-theft System	RF Digitally Encoded Security System (D.E.S.S.™) with Start/Stop button
Lighting	LED headlight, LED signature lights, LED tail lights
Winch	N/A
Magneto	850 W
Protection	Integrated front bumper, quarter doors, full roof, 4-point harness with shoulder pads, HMWPE full skid plate, rear tow hook

WARRANTY & EXTENDED SERVICE

Factory Warranty	2 years / 15,000 km, whichever comes first
Service Intervals	100 hours / 12 months / 3000 km



		Can-Am Maverick X3 X DS Turbo RR	Polaris Pro XP Premium EPS	Yamaha YZX1000R SS XT-R - 2023
Engine Size (cc)		900 cc	925 cc	998 cc
No of Cylinders	=	3	2	3
Horsepower	+	200 hp	181 hp	103 hp
Turbo	=	Yes	Yes	No
Transmission	+	pDrive primary and Quick Response System X CVT	Automatic PVT (CVT)	Constant Mesh 5 speed, paddle shift, auto clutch, with reverse
Front Diff. Type	+	Lockable front differential with exclusive Smart-Lok	Isolated Xtreme performance true on demand AWD/2WD	On command 3 way locking differential 2WD/4WD/diff lock
Power Steering	+	Hi torque tri-mode Dynamic Power Steering	Electronic Power Steering	Electronic Power Steering
Seating Capacity	=	2	2	2
Front Suspension	=	Double A-arm with sway bar	High clearance dual a-arm with stabilizer bar	Independent double wishbone with anti-sway bar
Rear Suspension	=	4-link torsional trailing arm X with sway bar	Trailing arm with stabilizer bar	Independent double wishbone with anti-sway bar
Wheel Size	=	14"	14"	14"
Wheel Material	=	Aluminium	Aluminium	Aluminium
Tyre Height	=	30"	30"	29"
Ground Clearance		35.6 cm	36.8 cm	33 cm
Overall Width	=	335.3 cm	320 cm	312.1 cm
Overall Length	+	162.5 cm	162.6 cm	162.6 cm
Vehicle Dry Weight		704.9 kg	809 kg	689.9 kg
Fuel Capacity		40 L	45.4 L	34 L
Anti Theft Device	+	RF Digitally Encoded Security system (D.E.S.S)	None	None
Warranty Period		2 years/15,000 km, whichever comes first	1 year unlimited km	3 years unlimited km
Display	+	7.6" wide digital display with keypad	7" glove touch display	Supersport-style dashboard

2023 CAN-AM MAVERICK X3 X_{RS} TURBO RR

WITH SMART-SHOX



■ Intense Blue, Carbon Black, & Chalk Gray / TURBO RR

PACKAGE HIGHLIGHTS

- 200 hp. turbo charged Rotax powerplant with intercooler
- 72.7 in. wide with over 55cm of suspension travel
- Smart-Lok front differential
- Smart-Shox Technology featuring DDA Valve
- FOX[®] 3.0 PODIUM[†] shocks with bypass
- Belt monitoring system
- 850 W magneto
- 7.6 in. digital display with keypad
- X-package graphics/seats
- 4-point harness with shoulder pads
- Can-Am LED signature lights
- 14 in. aluminum beadlock wheels
- 32 in. Maxxis Carnivore[†] tyres
- Full roof
- HMWPE full skid plate

ENGINE	TURBO RR
Type	200 hp, Rotax [®] ACE (Advanced Combustion Efficiency) 900 cc turbocharged triple-cylinder engine, liquid-cooled with integrated intercooler and high-performance air filter
Fuel Delivery System	Intelligent Throttle Control (iTC [™]) with Electronic Fuel Injection (EFI)
Transmission	pDrive primary and Quick Response System X (QRS-X) CVT with high airflow, L/H/N/R/P
Drive Train	Lockable front differential with exclusive Smart-Lok technology. True 4 modes traction system: 2WD/4WD with front diff. lock/4WD TRAIL ACTIV/4WD TRAIL
Power Steering	High torque Tri-Mode Dynamic Power Steering (DPS [™])

SUSPENSIONS

Front Suspension	Double A-arm with sway bar/22 in. (55.9 cm) travel/ Trophy truck inspired arms
Front Shocks	FOX 2.5 PODIUM Piggyback with bypass and Smart-Shox Technology featuring DDA Valve (Dynamic Damping Adjustment)
Rear Suspension	4-link Torsional Trailing-arm X (TTX) with sway bar/24 in. (61 cm) travel
Rear Shocks	FOX 3.0 PODIUM remote reservoir with bypass and Smart-Shox Technology featuring DDA Valve (Dynamic Damping Adjustment)

TYRES & WHEELS

Front Tyres	Maxxis Carnivore [†] 32 x 10 x 14 in.
Rear Tyres	Maxxis Carnivore [†] 32 x 10 x 14 in.
Wheels	14 in. cast-aluminum beadlock

BRAKES

Front	Dual 262 mm disc brakes with hydraulic twin-piston calipers
Rear	Dual 248 mm disc brakes with hydraulic twin-piston calipers

DIMENSIONS & CAPACITIES

Estimated Dry Weight	1,699 lb (770.7 kg)
Chassis/Cage	Dual-phase 980 steel
L x W x H	132 x 72.7 x 68.5 in. (335.3 x 184.7 x 174 cm)
Wheelbase	102 in. (259.1 cm)
Ground Clearance	16 in. (40.6 cm)
Rack Capacity	200 lb (91 kg) with LinQ [®] Quick-Attach
Storage Capacity	Total: 2.5 gal (9.4 L)
Fuel Capacity	10.5 gal (40 L)
Person Capacity	2

FEATURES

Gauge	7.6 in. wide digital display with keypad
Instrumentation	DC outlet (10-A)
Anti-theft System	RF Digitally Encoded Security System (D.E.S.S. [™]) with Start/Stop button
Lighting	LED headlight, LED signature lights, LED tail lights
Winch	N/A
Magneto	850 W
Protection	Integrated front bumper, quarter doors, full roof, 4-point harness with shoulder pads, HMWPE full skid plate, rear tow hook

WARRANTY & EXTENDED SERVICE

Factory Warranty	2 years / 15,000 km, whichever comes first
Service Intervals	100 hours / 12 months / 3000 km

2023 CAN-AM MAVERICK X3 X_{RC} TURBO RR 72"



■ Mineral Gray & Desert Tan / TURBO RR

ENGINE	TURBO RR
Type	200 hp, Rotax [®] ACE (Advanced Combustion Efficiency) 900 cc turbocharged triple-cylinder engine, liquid-cooled with integrated intercooler and high-performance air filter
Fuel Delivery System	Intelligent Throttle Control (ITC™) with Electronic Fuel Injection (EFI)
Transmission	pDrive primary and Quick Response System X (QRS-X) CVT with high airflow, L/H/N/R/P
Drive Train	Lockable front differential with exclusive Smart-Lok technology. True 4 modes traction system: 2WD/4WD with front diff. lock/4WD ROCK/4WD TRAIL
Power Steering	High-torque Tri-Mode Dynamic Power Steering (DPS™)

SUSPENSIONS

Front Suspension	Trophy truck inspired arched double A-arm with sway bar/22 in. (55.9 cm) travel
Front Shocks	FOX 2.5 PODIUM RC2 Piggyback with bypass, dual speed compression, and rebound adjustments
Rear Suspension	4-link Torsional Trailing-arm X (TTX) with sway bar and arched lower links/24 in. (61 cm) travel
Rear Shocks	FOX 3.0 PODIUM RC2 remote reservoir with bypass, dual speed compression and rebound adjustments

TYRES & WHEELS

Front Tyres	Maxxis Liberty [†] 32 x 10 x 15 in.
Rear Tyres	Maxxis Liberty [†] 32 x 10 x 15 in.
Wheels	15 in. cast-aluminum beadlock

BRAKES

Front	Dual 262 mm disc brakes with hydraulic twin-piston calipers
Rear	Dual 248 mm disc brakes with hydraulic twin-piston calipers

PACKAGE HIGHLIGHTS

- 200 hp. turbo charged Rotax powerplant with intercooler
- 72.8 in. wide with over 55cm of suspension travel
- Smart-Lok[®] front differential
- FOX[®] 3.0 PODIUM RC2[†] shocks with bypass
- Belt monitoring system
- 850 W magneto
- 7.6 in. digital display with keypad
- X-package graphics/seats
- 4-point harness with shoulder pads
- Can-Am LED signature lights
- 15 in. aluminum beadlock wheels
- 32 in. Maxxis Liberty[†] tyres
- Front bumper, half-doors, aluminum roof, intrusion bar
- Front tow hook
- 4,500 lb (2,041 kg) winch with synthetic rope
- HMWPE differential and under bumper skid plates
- HMWPE front and rear suspension arm
- UHMWPE rock sliders

DIMENSIONS & CAPACITIES

Estimated Dry Weight	1,843 lb (836 kg)
Chassis/Cage	Dual-phase 980 steel
L x W x H	134.5 x 72.8 x 68.5 in. (341.6 x 184.9 x 174 cm)
Wheelbase	102 in. (259.1 cm)
Ground Clearance	16 in. (40.6 cm)
Rack Capacity	200 lb (91 kg) with LinQ [®] Quick-Attach
Storage Capacity	Total: 2.5 gal (9.4 L)
Fuel Capacity	10.5 gal (40 L)
Person Capacity	2

FEATURES

Gauge	7.6 in. wide digital display with keypad
Instrumentation	DC outlet (10-A)
Anti-theft System	RF Digitally Encoded Security System (D.E.S.S.™) with Start/Stop button
Lighting	LED headlight, LED signature lights, LED tail lights
Winch	4,500 lb (2,041 kg) winch with synthetic rope
Magneto	850 W
Protection	Front bumper, Half doors, Aluminum roof, Intrusion bar, 4-point harness with shoulder pads, UHMWPE rock sliders, HMWPE skidplates: full heavy-duty with differential/under bumper/front and rear suspension arm

WARRANTY & EXTENDED SERVICE

Factory Warranty	2 years / 15,000 km, whichever comes first
Service Intervals	100 hours / 12 months / 3000 km

2023 CAN-AM MAVERICK X3 MAX X_{RS} TURBO RR

WITH SMART-SHOX



■ Intense Blue, Carbon Black, & Chalk Gray / TURBO RR

PACKAGE HIGHLIGHTS

- 200 hp. turbo charged Rotax powerplant with intercooler
- 72.7 in. wide with over 55cm of suspension travel
- Seating for 4 people
- Smart-Lok front differential
- Smart-Shox Technology featuring DDA Valve
- FOX® 3.0 PODIUM® shocks with bypass
- Belt monitoring system
- 850 W magneto
- 7.6 in. digital display with keypad
- X-package graphics/seats
- 4-point harness with shoulder pads
- Can-Am LED signature lights
- 14 in. aluminum beadlock wheels
- 32 in. Maxxis Carnivore® tyres
- Full roof
- HMWPE full skid plate

ENGINE	TURBO RR
Type	200 hp, Rotax® ACE (Advanced Combustion Efficiency) 900 cc turbocharged triple-cylinder engine, liquid-cooled with integrated intercooler and high-performance air filter
Fuel Delivery System	Intelligent Throttle Control (iTC™) with Electronic Fuel Injection (EFI)
Transmission	pDrive primary and Quick Response System X (QRS-X) CVT with high airflow, L/H/N/R/P
Drive Train	Lockable front differential with exclusive Smart-Lok technology. True 4 modes traction system: 2WD/4WD with front diff. lock/4WD TRAIL ACTIV/4WD TRAIL
Power Steering	High-torque Tri-Mode Dynamic Power Steering (DPS™)

DIMENSIONS & CAPACITIES

Estimated Dry Weight	1,942 lb (880.9 kg)
Chassis/Cage	Dual-phase 980 steel
L x W x H	165 x 72.7 x 68.5 in. (419.1 x 184.7 x 174 cm)
Wheelbase	135 in. (342.9 cm)
Ground Clearance	16 in. (40.6 cm)
Rack Capacity	150 lb (68 kg) with LinQ® Quick-Attach
Storage Capacity	Total: 3 gal (11.4 L)
Fuel Capacity	10.5 gal (40 L)
Person Capacity	4

SUSPENSIONS

Front Suspension	Double A-arm with sway bar/22 in. (55.9 cm) travel/ Trophy truck inspired arms
Front Shocks	FOX 2.5 PODIUM Piggyback with bypass and Smart-Shox Technology featuring DDA Valve (Dynamic Damping Adjustment)
Rear Suspension	4-link Torsional Trailing-arm X (TTX) with sway bar/22 in. (55.9 cm) travel
Rear Shocks	FOX 3.0 PODIUM remote reservoir with bypass and Smart-Shox Technology featuring DDA Valve (Dynamic Damping Adjustment)

TYRES & WHEELS

Front Tyres	Maxxis Carnivore® 32 x 10 x 14 in.
Rear Tyres	Maxxis Carnivore® 32 x 10 x 14 in.
Wheels	14 in. cast-aluminum beadlock

BRAKES





Front	Dual 262 mm disc brakes with hydraulic twin-piston calipers
Rear	Dual 248 mm disc brakes with hydraulic twin-piston calipers

FEATURES

Gauge	7.6 in. wide digital display with keypad
Instrumentation	DC outlet (10-A)
Anti-theft System	RF Digitally Encoded Security System (D.E.S.S.™) with Start/Stop button
Lighting	LED headlight, LED signature lights, LED tail lights
Winch	N/A
Magneto	850 W
Protection	Integrated front bumper, Quarter doors, Full roof, 4-point harness with shoulder pads, HMWPE full skid plate, Rear tow hook

WARRANTY & EXTENDED SERVICE

Factory Warranty	2 years / 15,000 km, whichever comes first
Service Intervals	100 hours / 12 months / 3000 km

MAVERICK X3		X ds TURBO RR	X rs TURBO RR	X rc TURBO RR 72"	MAX X rs TURBO RR
					
COLOUR OPTIONS		Triple Black	Intense Blue, Carbon Black, & Chalk Gray	Mineral Gray & Desert Tan	Intense Blue, Carbon Black, & Chalk Gray
ENGINES	Type	200 hp, Rotax® ACE (Advanced Combustion Efficiency) 900 cc turbocharged triple-cylinder engine, liquid-cooled with integrated intercooler and high-performance air filter			
	Fuel Delivery System	Intelligent Throttle Control (ITC™) with Electronic Fuel Injection (EFI)			
	Transmission	pDrive primary and Quick Response System X (QRS-X) CVT with high airflow, L/H/N/R/P			
	Drive Train	Lockable front differential with exclusive Smart-Lok* technology. True 4 modes traction system: 2WD/4WD with front diff. lock/4WD TRAIL ACTIV/4WD TRAIL.	Lockable front differential with exclusive Smart-Lok* technology. True 4 modes traction system: 2WD/4WD with front diff. lock/4WD ROCK/4WD TRAIL.	Lockable front differential with exclusive Smart-Lok* technology. True 4 modes traction system: 2WD/4WD with front diff. lock/4WD TRAIL ACTIV/4WD TRAIL.	Lockable front differential with exclusive Smart-Lok* technology. True 4 modes traction system: 2WD/4WD with front diff. lock/4WD TRAIL ACTIV/4WD TRAIL.
	Driving Assistance	High torque Tri-Mode Dynamic Power Steering (DPS™)			
SUSPENSIONS	Front Suspension	Double A-arm with sway bar/20 in. (50.8 cm) travel	Double A-arm with sway bar/22 in. (55.9 cm) travel/Trophy truck inspired arms	Trophy truck inspired arched double A-arm with sway bar/22 in. (55.9 cm) travel	Double A-arm with sway bar/22 in. (55.9 cm) travel/ Trophy truck inspired arms
	Front Shocks	FOX [†] 2.5 PODIUM RC2 [†] Piggyback with dual speed compression and rebound adjustments	FOX [†] 2.5 PODIUM Piggyback with bypass and Smart-Shox** Technology featuring DDA Valve (Dynamic Damping Adjustment)	FOX [†] 2.5 PODIUM RC2 [†] Piggyback with bypass, dual speed compression and rebound adjustments	FOX [†] 2.5 PODIUM Piggyback with bypass and Smart-Shox** Technology featuring DDA Valve (Dynamic Damping Adjustment)
	Rear Suspension	4-link Torsional Trailing-arm X (TTX) with sway bar/20 in. (50.8 cm) travel	4-link Torsional Trailing-arm X (TTX) with sway bar/24 in. (61 cm) travel	4-link Torsional Trailing-arm X (TTX) with sway bar and arched lower links/24 in. (61 cm) travel	4-link Torsional Trailing-arm X (TTX) with sway bar/22 in. (55.9 cm) travel
	Rear Shocks	FOX [†] 2.5 PODIUM RC2 [†] Piggyback with dual speed compression, rebound adjustments and bottom-out control	FOX [†] 3.0 PODIUM remote reservoir with bypass and Smart-Shox** Technology featuring DDA Valve (Dynamic Damping Adjustment)	FOX [†] 3.0 PODIUM RC2 [†] remote reservoir with bypass, dual speed compression and rebound adjustments	FOX [†] 3.0 PODIUM remote reservoir with bypass and Smart-Shox** Technology featuring DDA Valve (Dynamic Damping Adjustment)
TYRES/WHEELS	Front/Rear Tyres	Maxxis Carnivore [†] 30 x 10/10 x 14 in. 14 in. cast-aluminum beadlock	Maxxis Carnivore [†] 32 x 10/10 x 14 in. 14 in. cast-aluminum beadlock	Maxxis Liberty [†] 32 x 10/10 x 15 in. 15 in. cast-aluminum beadlock	Maxxis Carnivore [†] 32 x 10/10 x 14 in. 14 in. cast-aluminum beadlock
	Wheels				
BRAKES	Front	Dual 262 mm disc brakes with hydraulic twin-piston calipers			
	Rear	Dual 248 mm disc brakes with hydraulic twin-piston calipers			
DIMENSIONS/CAPACITIES	Estimated Dry Weight	1,554 lb (704.9 kg)	1,699 lb (770.7 kg)	1,843 lb (836 kg)	1,942 lb (880.9 kg)
	Chassis/Cage	Dual-phase 980 steel			
	L x W x H	132 x 64 x 65.7 in. (335.3 x 162.5 x 166.9 cm)	132 x 72.7 x 68.5 in. (335.3 x 184.7 x 174 cm)	134.5 x 72.8 x 68.5 in. (341.6 x 184.9 x 174 cm)	165 x 72.7 x 68.5 in. (419.1 x 184.7 x 174 cm)
	Wheelbase	102 in. (259.1 cm)			135 in. (342.9 cm)
	Ground Clearance	14 in. (35.6 cm)	16 in. (40.6 cm)		
	Rack Capacity	200 lb (91 kg) with LinQ® quick-attach			
	Storage Capacity	Total: 2.5 gal (9.4 L)			150 lb (68 kg) with LinQ® quick-attach
	Fuel Capacity	Total: 3 gal (11.4 L)			
FEATURES	Person Capacity	2			4
	Gauge	7.6 in. wide digital display with keypad			
	Instrumentation	DC outlet (10-A)			
	Anti-theft System	RF Digitally Encoded Security System (D.E.S.S.™) with Start/Stop button			
	Lighting	LED headlight, LED signature lights, LED tail lights			
	Winch	N/A	4,500 lb (2,041 kg) winch with synthetic rope		N/A
	Magneto	850 W			
	Protection	Integrated front bumper, quarter doors, full roof, 4-point harness with shoulder pads, HMWPE full skid plate, rear tow hook	Front bumper, half doors, aluminum roof, intrusion bar, 4-point harness with shoulder pads, UHMWPE rock sliders, HMWPE skidplates: full heavy-duty with differential/under bumper/ front and rear suspension arm		Integrated front bumper, quarter doors, full roof, 4-point harness with shoulder pads, HMWPE full skid plate, rear tow hook

*Smart-Lok was developed in conjunction with TEAM Industries, a market leader in the drive train industry.

**Smart-Shox was developed in conjunction with Tractive Industries, a market leader in the suspension industry.



ACCESSORIES MAVERICK X3

Image for visual purposes only. Package shown not available in region.

ROOFS

Sport Roof

Maverick X3
Maverick X3 MAX

715005521
715003750



- Impact-resistant injected polypropylene.
- Excellent protection from the elements.
- Provides excellent downhill visibility.
- Windshield compatible.
- Standard on X rs model.
- Easy, tool-less installation and removal with quick-release ¼ turn fasteners and Velcro straps.

ProVent Roof Module Kit

Maverick X3, Maverick X3 MAX

715005279



- Provides fresh air in the cab area.
- Optimal performance with full cab enclosure.
- 4 vents provide infinite adjustment of air flow for driver and passenger.
- Filter and pre-filter to limit dust intrusion.
- Easy cleaning of filter and pre-filter.
- Patent pending water management system to keep water out of cabin while maintaining air flow.
- Outer plug closes air intake completely for winter or heavy weather.
- Sport Roof requires ProVent Module Adapter Kit.
- Not compatible with roof mounted LED bars, roof racks or roof liners, Lonestar Roof, and Bimini tops.

ProVent Roof Module Adapter Kit for Sport Roof

(Not illustrated)

Maverick X3
Maverick X3 MAX

715006199
715006371

- Adapter for fitting ProVent Roof Module Kit onto Maverick X3.
- Includes roof adapter and hardware.
- Requires ProVent Roof Module Kit (715005279).

Aluminum Roof

Maverick X3

■ **715004224** · Black
■ **715002900** · Silver



- Formed aluminum roof 0.09" (2.3 mm) thick.
- Durable and lightweight.
- Sporty look.
- Windshield compatible.
- Easy and tool-less installation.

Bimini[†] Roof with Sun Visor

Maverick X3
Maverick X3 MAX

715002901
715003749



- Heavy-duty canvas made of UV-resistant solution-dyed polyester.
- Innovative soft top comes with a hard visor that allows for storage of rolled-up soft top.
- Easy, tool-less installation and removal with quick-release/turn fasteners and Velcro straps.

Tinted Sun Visor

Maverick X3, Maverick X3 MAX

715007098



- Tinted polycarbonate construction.
- Extra protection for driver and passenger from the sun.
- Not compatible with Aluminum Roof and Full Windshields.

Lonestar Racing Aluminum Roof

Maverick X3 produced after January 1, 2017

Maverick X3 MAX

■ **715005508** · Hyper Silver
■ **715005507** · Black
■ **715004436** · Can-Am Red
■ **715005516** · Hyper Silver
■ **715005515** · Black
■ **715004341** · Can-Am Red



- 0.083" (2.1 mm) thick aluminum roof.
- Durable and lightweight.
- Enhances the vehicle's racing appearance thanks to an authentic sporty look combined with unique graphics.
- Offers you protection from the elements with a personalized touch.
- Lower profile than other roofs.
- Compatible with Lonestar Racing Light Bar Racks.
- Not compatible with LinQ Pivoting Rack, Light Support Bar and Full Windshields.
- "Lonestar Racing for Can-Am" branded.
- Includes middle intrusion bars for installation.

SOFT CAB ENCLOSURE

Soft Cab Enclosure

Maverick X3 (except X mr models)

715003754

Maverick X3 MAX (except X mr models)

715003755



- Protection for rider and passenger from the elements.
- For added cabin comfort, complete your cab enclosure with Cab Seal Kit.
- Includes:
 - Bimini roof with sun visor
 - Full windshield — hardcoated
 - Upper soft door panels
 - Front lower door panels
 - Soft rear window

Cab Seal Kit

(Not illustrated)

Maverick X3

715004433

Maverick X3 MAX

715004434

- Prevents dirt, dust and wind infiltration in the cab area.
- Improves cabin comfort for driver and passenger.
- Recommended with Soft Cab Enclosures.

WINDSHIELDS & MIRRORS

Windshields

PowerFlip Windshield

Maverick X3, Maverick X3 MAX

715007097



- The PowerFlip Windshield is equipped with electric cylinders that allow the rider to adjust the windshield opening at the touch of a button.
- Windshield is made of hardcoated polycarbonate with a rubber seal contour and a tinted top section.
- Allows you to quickly adapt to changing conditions by adjusting the windshield as you go.
- Can be fully opened for optimal visibility and ventilation, fully closed for maximum protection from the elements, and in between, you have an infinite number of opening possibilities depending on protection, visibility and air flow preferences.
- Compatible with Can-Am roofs.

Windshield Wiper for PowerFlip Windshield

Maverick X3, Maverick X3 MAX

715006310



- An ideal way to keep your windshield clear in rain or while riding through mud and water.
- Wiper from the top allows windshield pivoting. Includes single-speed wiper and washer-fluid dispenser.
- Wiper mechanism and washer-fluid dispenser perfectly concealed within the vehicle.
- Must be installed with the PowerFlip Windshield (sold separately).

Provent Windshield

Maverick X3, Maverick X3 MAX

715005277



- High-impact-resistant Quantum hardcoated polycarbonate full windshield.
- Controllable vents to manage air flow.
- Optimal performance with full cab enclosure.
- Channels air into the cabin, defogs windshield, fully closes to eliminate air flow.
- One upper vent and one lower vent with pre-filters.
- Formed polycarbonate construction for enhanced rigidity.
- Provides excellent optical clarity and better abrasion resistance.
- Protects driver and passenger from the elements.
- Quick and easy tool-less installation or removal.
- Not compatible with wiper kits and Wet Sounds Stealth 6 Ultra HD Can-Am Edition Sound Bar.
- Upper vent channels air into the cabin.
- Lower vents defog windshield.

Glass Windshield	Maverick X3, Maverick X3 MAX	715008859
-------------------------	------------------------------	------------------



- Curved and laminated glass full windshield.
- Seals firmly against the cage and protects rider and passenger from the elements.
- Provides the best optical clarity and abrasion resistance.
- Must be used with Windshield Wiper & Washer Kit to maintain clear visibility during severe riding conditions, such as mud riding.
- Recommended to use with rear wind protection to maximize comfort for passenger.

Glass Windshield with Wiper & Washer Kit	Maverick X3, Maverick X3 MAX	715008858
---	------------------------------	------------------



- Complete kit that includes a curved and laminated glass windshield with a single-speed wiper and washer fluid dispenser.
- Seals firmly against the cage and protects rider and passenger from the elements.
- An ideal way to keep your windshield clear in rain, or while riding through mud and water.
- Recommended to use with rear wind protection to maximize comfort for passenger.

Full Windshield	Maverick X3, Maverick X3 MAX	715002907
------------------------	------------------------------	------------------



- High-impact-resistant durable polycarbonate full windshield.
- Formed polycarbonate construction for enhanced rigidity.
- Formulated to be non-yellowing, non-crazing, non-cracking with excellent UV resistance and optical clarity.
- Protects driver and passenger from the elements.
- Quick and easy tool-less installation or removal.
- Recommended to use with rear wind protection to maximize comfort for passenger.

Full Windshield – Hardcoated	Maverick X3, Maverick X3 MAX	715004417
-------------------------------------	------------------------------	------------------



- High-impact-resistant Quantum hardcoated polycarbonate full windshield.
- Formed polycarbonate construction for enhanced rigidity.
- Provides excellent optical clarity and better abrasion resistance.
- Protects driver and passenger from the elements.
- Quick and easy tool-less installation or removal.
- Recommended to use with rear wind protection to maximize comfort for passenger.
- Can be used with the Windshield Wiper and Washer Kit (715004762).

Windshield Wiper & Washer Kit	Maverick X3, Maverick X3 MAX Fit with Full Windshield Hardcoated (715004417)	715004762
	Maverick X3, Maverick X3 MAX Fit with Glass Windshield (715008859)	715003282



- An ideal way to keep your windshield clear in rain, or while riding through mud and water.
- Includes single-speed wiper and washer fluid dispenser.
- Wiper mechanism and washer fluid dispenser perfectly concealed within the vehicle.

Half Windshield	Maverick X3, Maverick X3 MAX	<input type="checkbox"/> 715002909 · Clear <input checked="" type="checkbox"/> 715004291 · Tinted
------------------------	------------------------------	--



- High-impact-resistant durable polycarbonate half windshield.
- Formed polycarbonate construction for enhanced rigidity.
- Formulated to be non-yellowing, non-crazing, non-cracking with excellent UV resistance and optical clarity.
- Protects driver and passenger from the elements.
- Features reverse angle lip to deflect air flow.
- Quick and easy tool-less installation or removal.

Mirrors

Rear Mirror & Camera Monitor

Maverick X3, Maverick X3 MAX

715004905



- Fully waterproof rear view camera and monitor kit.
- Multiple camera feeds can be seen with the rear view camera, to see what you need.
- Unit replaces stock rear view mirror (screen is integrated in the unit's replacement rear view mirror).
- Camera uses infrared light for night vision capabilities.

Side Mirrors

Maverick X3, Maverick X3 MAX

715004236
• For stock quarter doors
715005315
• For aluminum doors



- Rugged cast aluminum mount with black nylon cover.
- Multi-position adjustable ball-joint mounted mirrors.
- Convex optics for a wide viewing angle.
- Spring-loaded pivots let mirrors fold back completely.
- Door mounted.
- Compatible with Upper Soft Door Panels.
- Sold in pairs.

Racing Side Mirrors

Maverick X3, Maverick X3 MAX

715002898



- Race-inspired design features rugged black nylon ½ construction with coated cast-aluminum mount.
- Dual adjustment provides optimal field of view (FOV).
- Multi-position adjustable ball-joint mounted mirrors.
- Flat optics deliver improved distance perception.
- Spring-loaded pivots let mirrors fold back completely.
- Not compatible with Lonestar Racing Light Racks, Upper Soft Door Panels or Flip Audio Roof Kit (715007131).
- Sold in pairs.

Rally Side Mirrors

Maverick X3, Maverick X3 MAX

715005262



- Sleek design with unique racing style.
- High-quality black molded aluminum for extreme durability.
- 4" (10 cm) convex surface provides a wider field of view and better visibility around the unit.
- Can be installed at any height on the cage A-pillar for optimized rider vision.
- Multi-position adjustable ball-joint-mounted mirrors.
- Spring-loaded pivots let mirrors fold back completely.
- Sold in pairs.
- Not compatible with Glass Windshield.

DOORS

Aluminum Half Doors

Maverick X3, Maverick X3 MAX

715007971 · Front

Maverick X3 MAX

715007972 · Rear



- Lightweight half doors made of formed 5/64" (2 mm) thick aluminum.
- Smooth finish.
- Engineered for maximum rigidity and durability.
- Designed for a perfect fit and seamless integration with the vehicle's lines.
- Contoured with a thick seal for better protection from the elements.
- Easy installation using the standard door frame.
- Includes the easy-to-operate Deluxe Door Handles.
- Compatible with the Upper Soft Door Panels, the Window Nets and Upper Door Storage Bags.
- Not compatible with the Lower Door Panel Storage Bags.
- Sold in pairs.

Deluxe Door Handles	Maverick X3, Maverick X3 MAX	715004758 · Front
	Maverick X3 MAX	715004860 · Rear

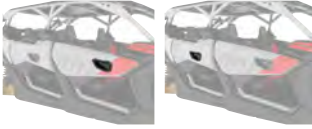

- Convert the standard door straps into easy-to-access door handles.
- Include inside and outside handles for each door.
- Greatly facilitate door opening.
- Standard on accessory Aluminum Half Doors.
- Sold in pairs.

Lower Door Panels	Maverick X3, Maverick X3 MAX	715002903 · Front
		715003751 · Rear



- Robust injection-molded polypropylene construction designed to match vehicle.
- Extend stock doors at bottom to protect and seal cab area.
- A great-looking add-on.
- Easy and quick installation.
- Sold in pairs.

Doors & Rear Wind Protection

Window Nets	Maverick X3	715006693 · Front
	Maverick X3 MAX	715004694 · Front
	Maverick X3 MAX	715006700 · Rear



- Window mesh screen for added protection from wind.
- Can be easily lowered in seconds.
- Sold in pairs.
- Not compatible with Can-Am Audio Roof.

Upper Soft Door Panels	Maverick X3 (except X mr models)	715008091 · 2 doors
	Maverick X3 MAX (except X mr models)	715008092 · 4 doors



- Weather-resistant panels reinforced with aluminum frame offer good protection from the elements.
- Extend stock quarter doors at the top.
- Made of heavy-duty UV-resistant solution-dyed polyester canvas for excellent resistance to tear and abrasion.
- Zip-down windows made of laminated polished vinyl material for added ventilation.
- To be combined with the Lower Door Panels to obtain complete door kits for your vehicle.
- Not compatible with Racing Side Mirrors and Can-Am Audio Roof.

Rear Wind Screen	Maverick X3, Maverick X3 MAX (except X mr models)	715006701
-------------------------	---	------------------



- Full rear mesh screen reduces windshield backdraft for added cabin comfort.
- Installs quickly and easily on roll cage.
- Large white Can-Am logo on black mesh.

Rear Polycarbonate Window	Maverick X3, Maverick X3 MAX (except X mr models)	715006387
----------------------------------	---	------------------



- High-impact-resistant polycarbonate window.
- Blocks windshield backdraft or dust and rain from entering for added cabin comfort.
- Quick and easy tool-less installation.
- Ready for MTX Audio System Rear Speakers.

Soft Rear Window	Maverick X3, Maverick X3 MAX (except X mr models)	715006702
-------------------------	---	------------------



- Clear, flexible window made from transparent vinyl.
- Resists cold-cracking to -4°F (-20 °C).
- Ideal for preventing backdraft of dust or rain in harsh environments.
- Quick tool-less installation.

HMWPE SKID PLATES

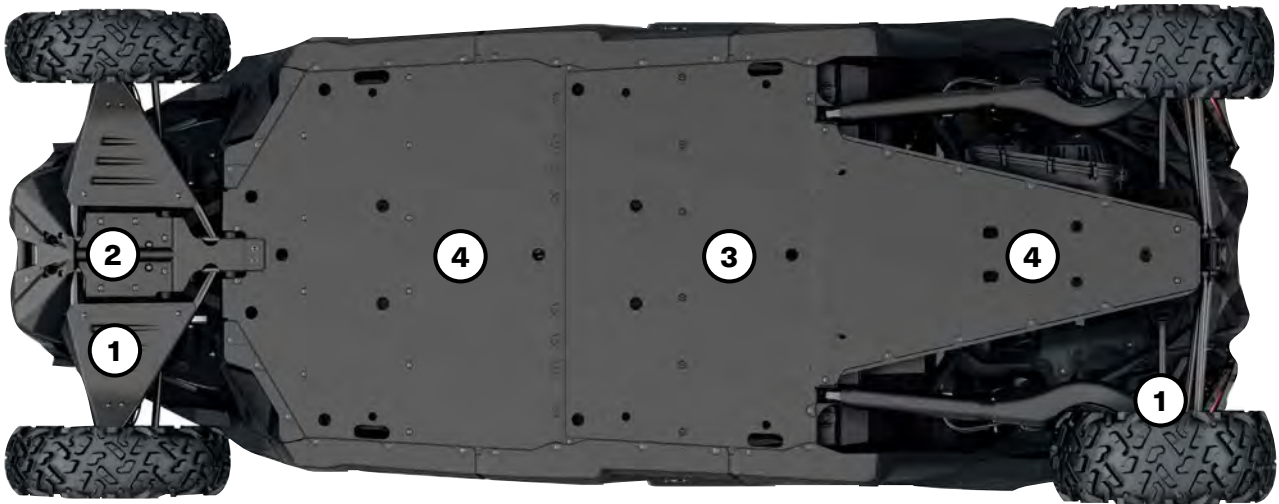

Our plastic plates glide smoothly and silently over obstacles, offering great protection in rough terrain. Made of abrasion-resistant thermoformed $\frac{3}{8}$ " (10 mm) thick High Molecular Weight Polyethylene (HMWPE).

- Lighter than aluminum.
- Superior stress crack resistance.
- High-impact strength.

MAVERICK X3, MAVERICK X3 MAX

HMWPE Skid Plates are standard on Maverick X3 X rc models.	Maverick X3 64" models	Maverick X3 Max 64" models	Maverick X3, Maverick X3 Max 72" models (except Base models)	Maverick X3 Base 72" models	Maverick X3 Max Base 72" models
HMWPE Skid Plate Protection Kit					
	715003713	715003747	715003718	715006767	715006769
Individual HMWPE Skid Plates					
① HMWPE Front A-Arm and Trailing Arm Protectors	715002905	715002905	715003552	715003552	715003552
② HMWPE Front Skid Plate	715003933	715003933	715003933	715003933	715003933
③ HMWPE Central Skid Plate	—	715003731	Standard on X rc models only	—	715003731
④ HMWPE Underbelly Plate	715004904	715004904	Standard on X rc models only	715004904	715004904

BUMPERS & GUARDS

Bumpers

Front Pre-Runner Bumper

Maverick X3, Maverick X3 MAX

■ **715002878** · Black
■ **715003433** · Can-Am Red



- Made of 1.5" (3.8 cm) diameter steel tubing with a 1/8" (3 mm) aluminum plate for extra durability.
- Inside and outside anti-corrosion coating with durable powder coat finish.
- Added heavy-duty protection in extreme driving conditions.
- Integrated winch mounting plate and mount points for lights.

Rear Pre-Runner Bumper

Maverick X3, Maverick X3 MAX

■ **715002880** · Black
■ **715003436** · Can-Am Red



- Extra-durable 1.5" (3.8 cm) diameter steel tubing with a 1/8" (3 mm) aluminum plate.
- Inside and outside anti-corrosion coating with durable powder coat finish.
- Protects vehicle bodywork and exhaust system.
- Rear Receiver Hitch compatible.
- Required for installation of the Rear Cage Extension.

Dune Front Bumper

Maverick X3, Maverick X3 MAX

■ **715002961** · Black
■ **715003432** · Can-Am Red



- Made of 1.5" (3.8 cm) diameter aluminum tubing with a 1/8" (3 mm) aluminum plate.
- Inside and outside anti-corrosion coating with durable powder coat finish.
- Provides added protection without sacrificing the agility and performance advantages of a lighter weight design.
- Features a more pronounced attack angle and integrated mounting points for lights.
- Not winch compatible.

Dune Rear Bumper

Maverick X3, Maverick X3 MAX 2021 & prior
Maverick X3, Maverick X3 MAX 2022 & up

■ **715002962** · Black
■ **715003437** · Can-Am Red
■ **715009242** · Black



- Made of 1.5" (3.8 cm) diameter aluminum tubing with a 1/8" (3 mm) aluminum plate.
- Inside and outside anti-corrosion coating with durable powder coat finish.
- Provides added protection without sacrificing the agility and performance advantages of a lighter weight design.
- Protects vehicle bodywork and exhaust system.
- Rear hitch compatible.
- Not compatible with Rear Cage Extension and Lonestar Racing Spare Tyre Holder.

X rc/X mr Front Bumper

Maverick X3, Maverick X3 MAX

■ **715004788** · Black



- Made of 1.5" (3.8 cm) diameter steel tubing with a 1/8" (3 mm) aluminum plate.
- Inside and outside anti-corrosion coating with durable powder coat finish on steel tubing.
- Offers all the essential features required for technical driving: low front-end protection, support base for winch installation and integrated tow hook.
- Standard on Maverick X3 X rc and X mr models.
- Not compatible with winches with steel cable.

Lonestar Racing Front Bumper

Maverick X3, Maverick X3 MAX
(not compatible X mr and X rc models)
Maverick X3, Maverick X3 MAX

■ **715005510** · Hyper Silver
■ **715005509** · Black
■ **715004161** · Can-Am Red



- Made of 1.5" (3.8 cm) diameter steel tubing with durable powder coat finish and a 1/8" (3 mm) thick aluminum plate for added vehicle-front protection in extreme driving conditions.
- Sleek styling enhances the vehicle's race-inspired look.
- Not winch compatible.
- Not compatible with 10" (25 cm) Baja Designs OnX6 LED Light Bar.
- Not compatible with stock Smart-Shox

Lonestar Racing Rear Bumper

Maverick X3, Maverick X3 MAX 2021 & prior

■ 715005512 · Hyper Silver
 ■ 715005511 · Black
 ■ 715004162 · Can-Am Red



- Made of 1.5" (3.8 cm) diameter steel tubing with durable powder coat finish.
- Provides additional vehicle-rear bodywork and exhaust system protection in extreme driving conditions.
- Sleek styling enhances the vehicle's race-inspired look.
- Compatible with Lonestar Racing Spare Tyre Holder.
- Not hitch compatible.

S3⁺ Front Bumper

Maverick X3, Maverick X3 MAX

■ 715004867 · Black



- Made of 1.5" (3.8 cm) diameter steel tubing with a 1/8" (3 mm) aluminum plate for extra durability.
- Inside and outside anti-corrosion coating with durable powder coat finish.
- Added heavy-duty protection in extreme driving conditions.
- Integrated winch support plate and mount points for lights.
- Hook support anchor allows you to keep the winch hook within easy reach when riding in deep mud.
- "S3 for Can-Am" branded.
- Winch not included.

S3 Rear Bumper

Maverick X3, Maverick X3 MAX 2021 & prior

■ 715004869 · Black
 ■ 715005232 · Can-Am Red



- Made of extra-durable 1.5" (3.8 cm) diameter steel tubing.
- Inside and outside anti-corrosion coating with durable powder coat finish.
- Added heavy-duty protection in extreme driving conditions—protects vehicle bodywork and exhaust system.
- Permits installation of a winch at a higher location to improve accessibility in muddy conditions.
- "S3 for Can-Am" branded.
- Engineered to sustain heavy winch loads without damaging the vehicle's frame.
- Compatible with Can-Am HD and WARN VRX winches—Rear Winch Harness 715006007 is required to install a winch on the bumper.
- Includes a robust recovery hook to facilitate vehicle recovery.
- Winch not included.
- Not EC compliant.

Rock Sliders

Rock Sliders

Maverick X3 (except X rc)

■ 715002963 · Black
 ■ 715003438 · Can-Am Red

Maverick X3 MAX

■ 715003730 · Black
 ■ 715003888 · Can-Am Red



- Made of heavy-duty 1.5" (3.8 cm) diameter steel tubing.
- Inside and outside anti-corrosion coating with durable powder coat finish.
- Protect vehicle's sides and undercarriage against large obstacles.
- Support plate adds rigidity and style.
- Sold in pairs.

X rc UHMWPE Rock Sliders

Maverick X3

715004730

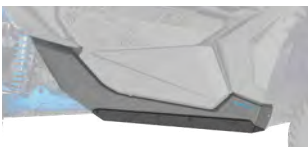

- Robust 1/4" (6 mm) UHMWPE construction.
- Include lower body panels and brackets for installation.
- Protect vehicle's sides and undercarriage against large obstacles.
- Lodge tight up against vehicle body for better clearance from obstacles.
- Slide smoothly over obstacles.
- Sold in pairs.

Lonestar Racing Rock Sliders

Maverick X3 MAX

■ 715005514 · Hyper Silver
 ■ 715008845 · Black
 ■ 715008846 · Can-Am Red

■ 715005518 · Hyper Silver
 ■ 715008847 · Black
 ■ 715008848 · Can-Am Red



- Race-engineered to Lonestar Racing's trademark standards for toughness, these stylishly crafted accessories will also enhance your vehicle with visual impact.
- Made of 1.5" (3.8 cm) diameter steel tubing with durable powder coat finish.
- Essential protection for your vehicle's sides from large obstacles.
- Sold in pairs.

Intrusion Bars

Front Intrusion Bar

Maverick X3, Maverick X3 MAX

■ **715002889** · Black
■ **715003435** · Can-Am Red



- Matches vehicle styling.
- Inside and outside anti-corrosion coating with durable powder coat finish steel intrusion bar.
- Tube design reduces obstructed lines of sight and blind spots for better visibility.
- Not compatible with windshields and Lonestar Racing Aluminum Roof.

Lonestar Racing Front Intrusion Bar

Maverick X3, Maverick X3 MAX

■ **715006342** · Hyper Silver
■ **715003916** · Black
■ **715004163** · Can-Am Red



- Made of 1.5" (3.8 cm) diameter steel tubing with durable powder coat finish.
- Enhances the racing look of the vehicle.
- Compatible with Lonestar Racing Aluminum Roof only.
- Not compatible with windshields.

Lonestar Racing Rear Intrusion Bar

Maverick X3 (except X mr models), Maverick X3 MAX

■ **715003918** · Black
■ **715004164** · Can-Am Red



- Made of 1.5" (3.8 cm) diameter steel tubing with durable powder coat finish.
- Sleek styling enhances the vehicle's race-inspired look.
- Required for the installation of the Lonestar Racing Spare Tyre Holder.
- Not compatible with LinQ mounted accessories and Pre-Filter in the cargo bed.

Other Accessories

Fender Flares

Maverick X3, Maverick X3 MAX

715002973



- Extended fender flares made from injection-molded polypropylene.
- Keep mud and debris out of vehicle.
- Designed for quick and easy installation.
- Include front and rear extensions and mounting hardware.

Lonestar Racing Spare Tyre Holder

Maverick X3, Maverick X3 MAX 2021 & prior
(except X mr models)

■ **715006344** · Hyper Silver
■ **715003922** · Black
■ **715004166** · Can-Am Red



- Made of 1.5" (3.8 cm) diameter steel tubing with durable powder coat finish.
- Adjustable height to fit Can-Am tyres up to 30 in.
- Requires Lonestar Racing Rear Bumper and Lonestar Racing Rear Intrusion Bar for installation.
- Cannot hold the Pro Armor Quickshot Wheel Jack and Off-Road Screw Jack.
- Wheel not included.
- Not compatible with the S&B Particle Separator and LinQ accessories intended for the rear of the vehicle.

Lonestar Racing Number Plate Holder

Maverick X3, Maverick X3 MAX

715003943



- Includes a pair of sturdy aluminum number plates that mount on either side of the vehicle rear.
- Not compatible with LinQ Pivoting Rack.
- Numbered decals are available through SCS Unlimited.
- Styling enhances the vehicle's race-inspired look while adding a personal touch.
- Black background.

Rear Cage Extension

Maverick X3 (except X mr models), Maverick X3 MAX

■ **715008298** · Black
■ **715008299** · Can-Am Red



- Durable 1.5" (3.8 cm) diameter steel tubing.
- Inside and outside anti-corrosion coating with durable powder coat finish.
- Allows holding a spare tyre in place (wheel not included).
- Custom tie-down strap for fast tyre installation or removal.
- Rear Pre-Runner Bumper required for installation.
- Not compatible with LinQ Pivoting Rack, cargo boxes (except LinQ 20 gal (73 L)
- Deluxe Modular Bag and Lonestar Racing roofs.

S3 Rear Pull Plate

Maverick X3, Maverick X3 MAX 2021 & prior

■ **715004870** · Black
■ **715005233** · Can-Am Red



- Offers a solid place to hook onto in case towing is needed.
- Allows you to attach most straps and hooks.
- "S3 for Can-Am" branded.

SEAT ACCESSORIES

4-Point Harness

Maverick X3, Maverick X3 MAX

715008033 · Driver
715008034 · Passenger



- Exclusive controlled decelerator technology (patent pending) absorbs additional energy in case of accident.
- Designed to offer maximum riding comfort.
- Easy one-click latch and release.
- Patent pending.
- Not EC compliant.

Retractable 4-Point Harness

Maverick X3, Maverick X3 MAX

715005021 · Driver
715005022 · Passenger



- Convenient harness allows you to move freely in your seat, and at the same time fully benefit from the extra support given by the 4-point attachments.
- Makes it easier to buckle up and requires fewer adjustments when switching passenger or driver.
- Retractor Protector (707900653) is required for installation on front seats of MAX models.
- Compatible with rear passenger seats on MAX models.
- Standard on select Maverick X3 models.

Retractor Protector

(Not illustrated)

Maverick X3 MAX

707900653

- Protective pad required for the installation of the Retractable 4-Point Harness on front seat of MAX models.
- Protects the passengers from the retractor mechanism.
- Sold individually.

Seat Belt Shoulder Pads

Maverick X3, Maverick X3 MAX

715002894



- Provide additional riding comfort by preventing seat belt from rubbing on neck and shoulder.
- Fit with stock 3-point seat belts and 4 point harness.
- Easy Velcro installation.
- Can-Am branded.
- Sold in pairs for driver and passenger.

LINQ: EASY ON, EASY OFF CARGO

MAVERICK'S LINQ ACCESSORIES

Mounting location and requirements

<ul style="list-style-type: none"> No tools needed: Quickly install and remove accessories by hand Equip your Can-Am for specialized tasks in no time Sturdy mounting system that holds up to the roughest terrain 	Standard Cargo Bed	LinQ Pivoting Rack 715008295/715008296	Adventure Roof Rack 715003868/715006225
LinQ Accessories with 16" Base <ul style="list-style-type: none"> LinQ anchors mounted 16 inches apart, center-to-center. Lower loading capacity than the LinQ with 36" base accessories. Can be used on Can-Am ATV and SSV vehicles, Can-Am Spyder and Ryker vehicles, Sea-Doo watercraft and Ski-Doo snowmobiles. 			
LinQ 4.2 Gal Cooler 295100698 • Gray 219400964 • Black	LinQ Anchor Adapter Kit 715004960	LinQ Anchor Adapter Kit 715004960	LinQ Base Installation Kit 715008125
LinQ Tool Kit 715006829			No further requirements
LinQ Tool Box 715008111			LinQ Base Installation Kit 715008125
LinQ SR 5.5 Gal (21 L) Bag 860202449			
LinQ 4.5 Gal (17 L) Sport Bag 860202447			No further requirements
LinQ Modular Box 715005494 • (10 L) 715007112 • (20 L) 715006830 • (30 L)			
LinQ Roll-Top Bag 715008110	LinQ Base Installation Kit 715008125		
LinQ Accessories with 36" Base <ul style="list-style-type: none"> Mount on LinQ racks often used by Can-Am ORV vehicles. Higher loading capacity than the LinQ with 16" base accessories. Usage is limited to Can-Am ORV vehicles. 			
LinQ 12 Gal (45 L) Cargo Box 715003879	No compatibility	No further requirements	No compatibility
LinQ 23 Gal (86 L) Trunk Box 715004923	No further requirements *Not compatible if the LinQ Pivoting Rack is installed.		
LinQ 32 Gal (121 L) Trunk Box 715001748			
LinQ 11.5 Gal (43 L) Audio Cargo Box 715003018	No further requirements		
LinQ 8 Gal (30 L) Cooler Box 715004778 • Black 715004698 • Gray			
LinQ Premium Storage Bag by OGIO[†] 715002923 • Black	No further requirements		
LinQ Heavy Duty Basket 715001215	No further requirements		
LinQ Low Profile Basket 715004282			
LinQ Holders			
LinQ Gear Grips 715005340	No further requirements	No further requirements	Side wall installation LinQ Adapters 715003058
LinQ Tool Holder 715007358			

LinQ Accessories with 16" base

LinQ Modular Box	Maverick X3, Maverick X3 MAX	715005494 · (10 L)
		715007112 · (20 L)
		715006830 · (30 L)



- Modular LinQ cargo boxes with 10 L (2.6 gal) capacity.
- Allows stacking of other modular boxes to always have the right gear accessible.
- Always have the right box size to fit everything.
- Can be installed on any LinQ base with a 16" width.
- See table for installation location and requirements.

Thermal Insert for LinQ Modular Box (10 L)	Maverick X3, Maverick X3 MAX	219401110
---	------------------------------	------------------



- Insulated liner.
- Fits very well in the LinQ Modular Box (10 L).
- Can contain five 473 ml cans or six 355 ml cans.

LinQ Tool Box	Maverick X3, Maverick X3 MAX	715008111
----------------------	------------------------------	------------------



- High precision injected HDPE construction provides rigidity and durability.
- 5 gal (19 L) maximum capacity.
- Weather-resistant, sealed and lockable cover.
- Easy one-second on/off tool-less system.
- All the benefits of LinQ—simple, fast and secure.
- See table for installation location and requirements.

LinQ Tool Kit	Maverick X3, Maverick X3 MAX	715006829
----------------------	------------------------------	------------------



- Includes:
 - Cutter pliers
 - Long-nose pliers
 - Locking pliers
 - Ratchet wrench 3/8" drive
 - 6" ratchet extension
 - Integrated CVT belt storage location (belt not included)
 - Long-socket 19 mm 3/8" drive - 6pts
 - Socket 18 mm 3/8" drive
 - Long-socket 17 mm 3/8" drive - 6pts
 - Socket 15 mm 3/8" drive
 - Socket 13 mm 3/8" drive
 - Socket 10 mm 3/8" drive
 - Socket 8 mm 3/8" drive
 - Combined wrench 19 mm
 - Combined wrench 18 mm
 - Combined wrench 15 mm
 - Combined wrench 13 mm
 - Combined wrench 10 mm
 - Combined wrench 8 mm
 - Socket Torx T30 3/8" drive
 - Socket Torx T20 3/8" drive
 - Breaker bar 3/8" drive
- See table for installation location and requirements

LinQ 4.2 Gal (16 L) Cooler	Maverick X3, Maverick X3 MAX	<ul style="list-style-type: none"> ■ 219400964 · Black ■ 295100698 · Gray
-----------------------------------	------------------------------	---



- All the benefits of LinQ—simple, fast and secure.
- Rotomolded construction for exceptional rigidity and durability.
- Premium-quality foam insulation for optimal ice retention.
- Uses LinQ mounting system (Patent US 8777531 and US 8875830).
- Easy one-second on/off tool-less system.
- See table for installation location and requirements.

LinQ 4.5 Gal (17 L) Sport Bag	Maverick X3, Maverick X3 MAX	860202447
--------------------------------------	------------------------------	------------------



- 17-liter (4.5 US gallon, 1,037 cu. in.) capacity.
- Rigid bottom, semi-rigid top.
- See table for installation location and requirements.

SR 5.5 Gal (21 L) LinQ Bag	Maverick X3, Maverick X3 MAX	860202449
-----------------------------------	------------------------------	------------------



- All the benefits of LinQ—simple, fast and secure.
- Semi-rigid expandable bag.
- 5.5 gal (21 L) capacity.
- Utilizes LinQ mounting system (Patent US 8777531 and US 8875830).
- Easy one-second on/off tool-less system.
- See table for installation location and requirements.

LinQ Roll-Top Bag	Maverick X3, Maverick X3 MAX	715008110
--------------------------	------------------------------	------------------



- Fully waterproof roll-top dry bag will securely store and confine your equipment.
- LinQ mounted using heavy-duty rigid plastic base.
- High capacity storage solution (40 L).
- Bottom foam liner for additional equipment protection.
- Integrated handle for easy transportation on/off the vehicle.
- See table for installation location and requirements.

LinQ Accessories with 36" base

LinQ 12 Gal (45 L) Cargo Box	Maverick X3, Maverick X3 MAX	715003879
-------------------------------------	------------------------------	------------------



- LinQ mounted for easy-on, easy-off installation.
- Holds cargo safely and securely while riding.
- See table for installation location and requirements.

LinQ 23 Gal (86 L) Trunk Box	Maverick X3 (except X mr models), Maverick X3 MAX	715004923
-------------------------------------	---	------------------



- LinQ mounted for easy-on, easy-off installation.
- Holds cargo safely and securely while riding.
- See table for installation location and requirements.

LinQ 32 Gal (121 L) Trunk Box	Maverick X3 (except X mr models), Maverick X3 MAX	715001748 · (No rear tail light)
--------------------------------------	---	---



- Equipped with the LinQ System, the rear trunk box plugs in and out in seconds.
- 32 gal (121 L) load capacity with unobstructed space to maximize storage room and access to the trunk's interior.
- Made of injection-molded polyethylene, double walled in critical areas.
- The fully sealed lid protects your belongings from dust, moisture and the elements.
- No rear tail light.
- Trunk Box Panels available in many colours to match your vehicle (sold separately).
- See table for installation location and requirements.

LinQ 32 Gal (121 L) Trunk Box Panels	Fit with LinQ 32 Gal (121 L) Trunk Box EUROPEAN VERSION (EC compliant)
---	---

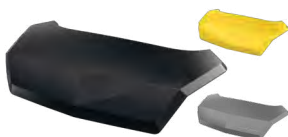

- Colour panels to match the LinQ 32 gal (121 L) Trunk Box to your vehicle.
- No rear tail light

- | | |
|---------------------------------|-----------------------------------|
| ■ 715001397 · Black | ■ 715006122 · Manta Green |
| ■ 715001398 · Yellow | ■ 715006123 · Orange Crush |
| ■ 715002483 · White | ■ 715006124 · Viper Red |
| ■ 715006121 · Can-Am Red | |

LinQ 8 Gal (30 L) Cooler Box	Maverick X3, Maverick X3 MAX	■ 715004778 · Black ■ 715004698 · Gray
-------------------------------------	------------------------------	---



- LinQ mounted for easy-on, easy-off installation.
- Rotomolded construction provides exceptional rigidity and durability.
- Premium-quality foam insulation for optimal ice retention.
- Integrated, fully removable compartment protects food.
- Robust rubber latches keep the cover tightly closed.
- Weather-resistant.
- Convenient drain plug.
- See table for installation location and requirements.

LinQ 11.5 Gal (43 L) Audio Cargo Box

Maverick X3, Maverick X3 MAX

715003018

- An affordable and quick solution for adding music and storage to your next ride.
- The rear installation does not use up any cab space and allows easy listening at an average speed.
- Mounts on/off easily to hold/carry cargo safely and securely.
- Backlit control panel perfect for night riding.
- Water-resistant speakers.
- The Bluetooth[®] enabled receiver and 6.5" (16.5 cm) speakers are smartly concealed and integrated in the cover.
- Automatic shut-off function protects your battery by turning the system off after 10 minutes of inactivity.
- See table for installation location and requirements.

LinQ Heavy-Duty Basket

Maverick X3, Maverick X3 MAX

715001215

- Made of high-strength, low-alloy steel.
- LinQ mount for easy-on, easy-off installation.
- See table for installation location and requirements.

LinQ Premium Storage Bag by OGIO

Maverick X3, Maverick X3 MAX

715002923 · Black

- Tool-less installation and removal thanks to the LinQ system.
- 17.2 gal (65 L) capacity semi-rigid cargo bag ideal for carrying anything you need on your vehicle.
- Buckle and elastic closure with a rubber seal that protects dust from entering the bag.
- 3-section lid for partial or full access to your bag.
- Inside separators for optimal bag organization.
- See table for installation location and requirements.

LinQ Low Profile Basket

Maverick X3, Maverick X3 MAX

715004282

- Low profile, open basket increases cargo space.
- Perfect for easy access to tools, rope, winch and plow accessories.
- Multiple bungee cord and tie-down anchor points.
- Made of impact-resistant injected polypropylene.
- See table for installation location and requirements.

LinQ Holders**LinQ Tool Holder**

Maverick X3, Maverick X3 MAX

715007358

- Ultra-versatile tool holder.
- Convenient swivel-latch allows tools to be stored in any orientation.
- Sold in pairs.

LinQ Gear Grips

Maverick X3, Maverick X3 MAX

715005340

- Durable and flexible grips provide a custom fit for a variety of items from 1" to 4" (2.5 cm to 10 cm) in diameter.
- Heavy-duty design for carrying bows, fishing poles, rakes, farm tools and more.
- Quick-release button opens grip quickly for easy access to gear.
- Heavy-duty base system built for the toughest adventures.
- Make transporting your tools a snap by combining the LinQ Gear Grips with the LinQ System.
- 360° orientation.
- Sold in pairs.

LinQ Mounting

LinQ Anchor Adapter Kit

Maverick X3, Maverick X3 MAX

715004960



- Allows the installation of LinQ accessories with 16" base on LinQ racks.
- Tool-less installation and removal.

LinQ Base Installation Kit

Maverick X3, Maverick X3 MAX

715008125



- Allows installation of compatible LinQ accessories.
- Included: 2 LinQ Cargo bases and hardware.

Tube LinQ Adapter

Maverick X3, Maverick X3 MAX

715004292



- Cage mounted LinQ receiver.
- Included in the LinQ Pivoting Rack assembly.
- Allows the installation of single LinQ mounted accessory.
- Diameter: 1.85" (47 mm).

LinQ Lock

Maverick X3, Maverick X3 MAX

860201968



- Simple way to securely lock most LinQ accessories.
- Lock cover protects lock from the elements.
- Corrosion resistant.
- Pack of 1, includes 2 keys.
- Not compatible with LinQ 4.2 US gal (16 L) Cooler, LinQ Tool Box, LinQ Tool Holder or LinQ Gear Grips.

LinQ Replacement Part

Maverick X3, Maverick X3 MAX

715001707



- Unique mounting fastener usable on any LinQ System accessory.
- Tool-less installation and removal.
- Sold in pairs.

LinQ Adapter

(Not illustrated)

Maverick X3 MAX

715003058

- Allows the installation of the LinQ Tool Holder on the Adventure Roof Rack.
- Sold in pack of 4.

Cargo Box Net

Maverick X3, Maverick X3 MAX

715001371



- Solid net designed to secure and ensure the compact confinement of your Adventure Roof Rack.

Spare Tyre Ratchet Tie-Downs

Maverick X3, Maverick X3 MAX

280000955



- 3-way ratcheting tie-down strap with loop ends.
- Designed to securely hold spare tyres on accessories equipped with integrated spare tyre attachment points.
- Adjustable to accommodate most common UTV tyre sizes.
- Ratchet and junction ring made of durable zinc-plated steel.
- Required for spare tyre attachment on Adventure Roof Rack.

RACKS & STORAGE

Racks

LinQ Pivoting Rack	Maverick X3 (except X mr models), Maverick X3 MAX	<ul style="list-style-type: none"> ■ 715008295 · Black ■ 715008296 · Can-Am Red
	<ul style="list-style-type: none"> • LinQ latched rack allows for extra LinQ mounted accessories or for carrying a spare tyre (tyre not included). • Includes custom tie-down strap for fast spare tyre installation or removal (tyre not included). • Gas-cylinder pivot action, locks in the raised position. • Trunk Boxes over 20 gal (74 L) do not fit on the vehicle when the rack is installed. • Not compatible with Rear Intrusion Bars, Rear Cage Extension and Lonestar Racing Aluminum Roofs. 	

Adventure Roof Rack	Maverick X3 Maverick X3 MAX	<ul style="list-style-type: none"> 715006225 715003868
	<ul style="list-style-type: none"> • Ideal cargo solution for packing everything you need to live your Off-Road experience fully and completely. • Built with lightweight 1.25" (3.2 cm) diameter steel tubing. • Integrated mounting points for lights can hold up to eight pod-type LED lights (six front and two back) or a 40" (102 cm) LED bar (front). • Features anchor points for spare-tyre attachment. • LinQ anchor on both sides. • Spare Tyre Tie-Downs sold separately. • Add the Cargo Box Net to secure and confine your cargo in the rack. • Loads up to 75 lb (34 kg). 	

Storage

Shoulder Storage Bag	Maverick X3 (except X mr models), Maverick X3 MAX (rear only)	715004277
	<ul style="list-style-type: none"> • Bag attaches in unused space between the seats to increase your vehicle's cargo capacity. • Installs between the rear seats only on MAX models. 	

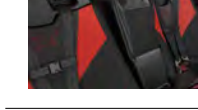
Front Shoulder Storage Bag	Maverick X3 MAX	715004888
	<ul style="list-style-type: none"> • Opens on each side so that both front and rear passengers can access the bag's content. • Installs between the driver and passenger seats on MAX models. 	

Overhead Storage Bag	Maverick X3, Maverick X3 MAX	715004275
	<ul style="list-style-type: none"> • Weather-resistant bag, holds your gear safely and securely while riding. • Makes smart use of your overhead space to increase your vehicle's cargo capacity by 2.6 gal (10 L). • Semi-rigid construction renders it flexible enough to fit odd-shaped loads. • Touchscreen-compatible clear front pocket allows for easy access to your smartphone. • Not compatible with the Bimini Roof. 	

Upper Door Storage Bags	Maverick X3, Maverick X3 MAX	715004276
	<ul style="list-style-type: none"> • Weather-resistant, they'll hold your gear safely and securely while riding. • Bags attach on stock quarter doors to increase your vehicle's cargo space. • Each bag is designed as a 1.3 gal (5 L) capacity pocket also equipped with inner netting compartments. • Semi-rigid construction renders them flexible enough to fit odd-shaped loads. • Sold in pairs. 	

Lower Door Panel Storage Bags	Maverick X3, Maverick X3 MAX	715004355
	<ul style="list-style-type: none"> • Weather-resistant, they'll hold your gear safely and securely while riding. • Bags attach on Lower Door Panels to increase your vehicle's cargo space. • Each bag is designed as a 1.6 gal (6 L) capacity pocket also equipped with inner netting compartments. • Semi-rigid construction renders them flexible enough to fit odd-shaped loads. • Sold in pairs. • Not compatible with aluminum doors and Off-Road Screw Jack. • Lower add-on doors required for installation. 	

Soft Storage Bag

Maverick X3, Maverick X3 MAX

715003759



- 11.8 gal (45 L) capacity soft cargo bag designed with vehicle's rear in mind to maximize potential storage.
- 3 sections.
- Weatherproof.

Storage 2.6 Gal (10 L) Bag

Maverick X3, Maverick X3 MAX

269502121



- Roll-top dry bag for fully protecting your cargo from the elements.

LIGHTS

2 Choose your lights

1 Choose your mount point	BAJA DESIGNS [†] LIGHTS					CAN-AM LIGHTS				
	10" (25 cm) LED light bar	40" (102 cm) Baja Design OnX6 Arc LED Light Bar	XL Sport LED lights (sold in pairs)	Squadron Sport LED Lights (sold in pairs)	XL80 LED lights (sold in pairs)	10" double stacked LED bar	15" double stacked LED bar	39" double stacked LED bar	4" round LED lights (sold in pairs)	3.5" spot or flood LED lights (sold in pairs)
	Consult p. 95 information on Baja Designs lights.					Consult p. 96 for information on Can-Am lights.				
Front Pre-Runner or Dune Bumpers	710006819 + 715007049 (Power Cable)	710006818 + 715007117 (Power Cable)	710006821 + 715002884 (Power Cable)	710006820 + 715002884 (Power Cable)	710005041 + 715007049 (Power Cable)	715002933 + 715003417 (Power Cable)	715002934 (Not compatible with Pre-Runner Bumper) + 715003417 (Power Cable)		715002935 (4" Round), 715003665 (3.5" Flood) or 715003666 (3.5" Spot) + 715003417 (Power Cable)	
Lonestar Racing Front Bumper	NA	710006818 + 715007117 (Power Cable)	710006821 + 715002884 (Power Cable)	710006820 + 715002884 (Power Cable)	710005041 + 715007049 (Power Cable)				715002935 (4" Round), 715003665 (3.5" Flood) or 715003666 (3.5" Spot) + 715003417 (Power Cable)	
Light Support Bar or Adventure Roof Rack	710006819 + 715007049 (Power Cable)	710006818 + 715007117 (Power Cable)	710006821 + 715002884 (Power Cable)	710006820 + 715002884 (Power Cable)	710005041 + 715007049 (Power Cable)	715002933 + 715003417 (Power Cable)	715002934 + 715003417 (Power Cable)	710004007 + 715005822 (Light Mounting Kit)	715002935 (4" Round), 715003665 (3.5" Flood) or 715003666 (3.5" Spot) + 715003417 (Power Cable)	
Lonestar Racing 40" (102 cm) LED Light Bar Rack	NA	710006818 + 715007117 (Power Cable)	NA	NA	NA	NA	NA	NA	NA	NA
Lonestar Racing Light Rack	NA	NA	710006821 + 715002884 (Power Cable)	NA	710005041 + 715007049 (Power Cable)	NA	NA	NA	NA	NA

3 Order

Order all part numbers in intersecting box

**Note: When installing more than one light kit, additional light power cable or mounting kit is required.*

*All lights are intended for off-road use only.

Lights Power Cable

(Not illustrated)

Maverick X3, Maverick X3 MAX

715003417
715007049
715002884
715007117

- Required for installation of Baja Designs LED lights onto roof or bumper.
- 10" (25 cm) Baja Designs OnX6 LED Bars and Baja Designs XL80 LED Lights (715007049).
- Baja Designs XL Sport LED Lights and Baja Designs Squadron Sport LED Lights (715002884).
- 40" (102 cm) Arc LED Light Bar ONX6 (715007117).

40" (102 cm) Baja Designs OnX6 Arc LED Light Bar

Maverick X3, Maverick X3 MAX

710006818

29,000 lumens

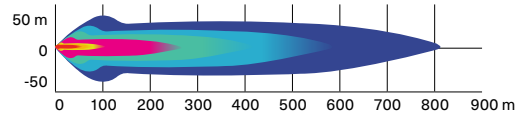

- 252 W light bar producing 29,000 lumens.
- Equipped with 24 Cree XM-L2 LEDs.
- Driving/Combo light pattern for smooth blend of light for both near field applications and distance.

- Designed for installation onto Light Support Bar equipped roofs.
- Requires Light Power Cable and Light Support Bar.

Baja Designs 10" (25 cm) OnX6 LED Light Bar

Maverick X3, Maverick X3 MAX

710006819

12,460 lumens

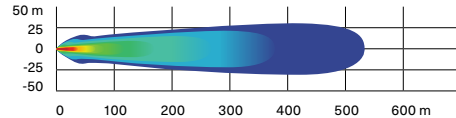

- 108 W light bar producing 12,460 lumens.
- Equipped with 6 Cree XM-L2 LEDs.
- Driving/combo light pattern for smooth blend of light for both near field applications and distance.

- Dual intensity (high/low) settings.
- Requires Baja Designs Light Power Cable.

Baja Designs XL80 LED Lights

Maverick X3, Maverick X3 MAX

710005041

9,500 lumens

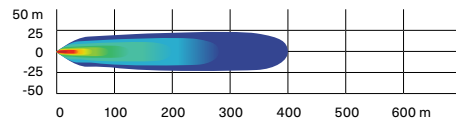

- 80 W per spot producing 9,500 lumens.
- Equipped with 4 Cree XHP50 LEDs per spot.
- Dual intensity (high/low) settings.
- Driving/combo light pattern for smooth blend of light for both near field applications and distance.

- Require Baja Designs Light Power Cable.
- Sold in pairs.
- Dimensions: 4.5" x 4.5" (11.4 cm x 11.4 cm).

Baja Designs Squadron Sport LED Lights

Maverick X3, Maverick X3 MAX

710006820

3,150 lumens

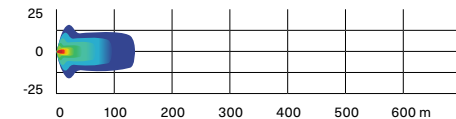

- 26 W per spot producing 3,150 lumens.
- Equipped with 4 Cree XP-G2 LEDs per spot.
- Wide cornering light pattern designed specifically for cornering, dust and/or fog conditions.

- Require Baja Designs Light Power Cable.
- Sold in pairs.
- Dimensions: 3" x 3" (7.6 cm x 7.6 cm).

Baja Designs XL Sport LED Lights

Maverick X3, Maverick X3 MAX

710006821

3,150 lumens

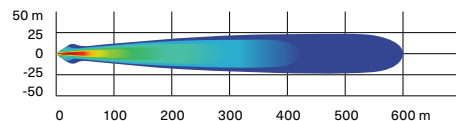

- 26 W per spot producing 3,150 lumens.
- Equipped with 4 Cree XP-G2 LEDs per spot.
- High Speed Spot features a longer and narrower beam focus for illumination farther down.

- Require Baja Designs Light Power Cable.
- Sold in pairs.
- Dimensions: 4.5" x 4.5" (11.4 cm x 11.4 cm).

10" (25 cm) Double Stacked LED Light Bar (60 W)

Maverick X3, Maverick X3 MAX

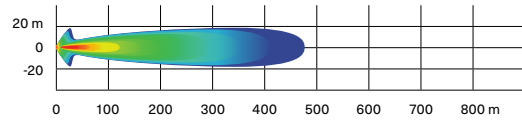
715002933**5,400 lumens**

- Equipped with twelve 5 W Cree LEDs.
- 5,400 lumens.
- Packs a big punch for its size.
- Rugged and waterproof.

- Requires light power cable for installation.
- Lights up to more than 1,500 ft. (460 m) in front of the vehicle and around 65 ft. (20 m) wide on each side.
- EC compliant.

15" (38 cm) Double Stacked LED Light Bar (90 W)

Maverick X3, Maverick X3 MAX

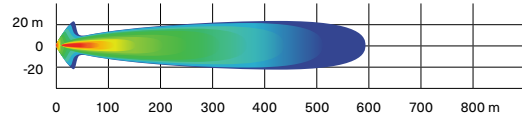
715002934**8,400 lumens**

- Equipped with 18 5 W Cree LEDs.
- 8,400 lumens.
- Complements the Light Racks and most bumpers.

- Rugged and waterproof.
- Lights up to more than 1,900 ft. (580 m) in front of the vehicle and around 65 ft. (20 m) wide on each side.
- EC compliant.

39" (99 cm) Double Stacked LED Light Bar (270 W)

Maverick X3, Maverick X3 MAX

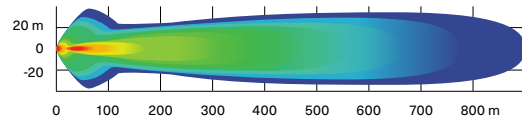
715004007**24,300 lumens**

- Equipped with 54 5 W Cree LEDs.
- 24,300 lumens.
- Lights up to more than 2,900 ft. (900 m) in front of the vehicle and around 115 ft. (35 m) wide on each side.

- Compatible on the Adventure Roof Rack.
- Refer to light chart for installation requirements.

4" (10 cm) Round LED Lights (2 x 25 W)

Maverick X3, Maverick X3 MAX

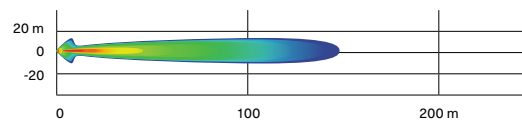
715002935**1,800 lumens**

- 25 W LED spotlights.
- 1,800 lumens.

- Rugged and waterproof.
- Includes basic wiring and switch.

- Can-Am branded grill.
- Requires light power cable.

- Sold in pairs.
- Not EC compliant.

3.5" (9 cm) LED Driving Lights (2 x 14 W)

Maverick X3, Maverick X3 MAX

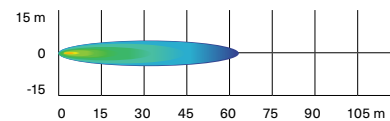
715003666**1,260 lumens**

- 14 W LED lights producing 1,260 lumens each.
- Spot lens for a narrow and long light beam spread, ideal when driving at higher speeds.
- Equipped with six high-power LEDs in a heavy-duty die-cast aluminum housing.

- Features two attachment points. If one attachment point fails due to a collision, rotate to the next channel point and remount the light.
- Sold in pairs.
- EC compliant.

3.5" (9 cm) LED Flood Lights (2 x 14 W)

Maverick X3, Maverick X3 MAX

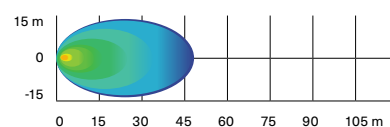
715003665**1,260 lumens**









- 14 W LED lights producing 1,260 lumens each.
- Flood lens for a wide light beam spread, ideal for working applications like plowing or cornering. Suitable for dusty or foggy riding conditions.

- Equipped with six high-power LEDs in a heavy-duty die-cast aluminum housing.
- Features two attachment points. If one attachment point fails due to a collision, rotate to the next channel point and remount the light.
- Sold in pairs.
- EC compliant.

Can-Am LED Signature Lights	Maverick X3, Maverick X3 MAX	715003673
	<ul style="list-style-type: none"> • Add style with a more aggressive look. • Use bright and energy efficient LEDs. • Do not give additional lighting for driving. 	
Dome Light	Maverick X3, Maverick X3 MAX	715002455
	<ul style="list-style-type: none"> • LED array integrates perfectly with vehicle. • Wiring included. • Can be installed on cage, Sport Roof or All-Terrain Trunk Cover. 	
Lonestar Racing 40" (102 cm) LED Light Bar Rack	Maverick X3, Maverick X3 MAX	715003920
	<ul style="list-style-type: none"> • Designed for use with 40" (102 cm) Baja Designs OnX6 Arc LED Light Bar. • Enhances the vehicle's race-inspired look. • Compatible with Aluminum Roof, Lonestar Racing Aluminum Roof and Sport Roof. • Not compatible with Racing Side Mirrors and PowerFlip Windshield. • Lights sold separately. 	
Lonestar Racing Light Rack	Maverick X3, Maverick X3 MAX	715003948
	<ul style="list-style-type: none"> • Designed for use with Baja Designs XL80 LED Light and Baja Designs XL Sport LED Light. • Accommodates up to two pairs of XL Lights. • Not compatible with Racing Side Mirrors and PowerFlip Windshield. • Compatible with Lonestar Racing Aluminum Roof, Aluminum Roof and Sport Roof. • Lights sold separately. 	
Chase Lights	Maverick X3, Maverick X3 MAX	715002887
	<ul style="list-style-type: none"> • Designed by Can-Am to make you visible to vehicles riding behind you, especially in dusty or harsh conditions. • Feature in-dash switches to activate one of the two modes and to choose among 11 different high-visibility coloured light patterns (blue, red and yellow). • Trail Mode: Serves as a tail light and as a brake light. • Race Mode: Displays light patterns and serves as a brake light (brake light function can be deactivated for racing applications). • Modular to allow installation with rear roll cage mounted accessories. • Plug-and-play installation. 	
Light Support Bar	Maverick X3, Maverick X3 MAX	715003529
	<ul style="list-style-type: none"> • Sleekly styled rugged aluminum construction. • Accommodates light bars and spotlights with or without any roof and windshield combination. • Full vehicle width to allow the installation of any large LED light bar. • Required for light installation on vehicle's roof. • Not compatible with Lonestar Racing Aluminum Roof. • Lights sold separately. 	
Mounting Kit for 39" (99 cm) LED Light Bar <i>(Not illustrated)</i>	Maverick X3, Maverick X3 MAX	715005822
<ul style="list-style-type: none"> • Required for installation of the 39" (99 cm) double stacked LED Light Bar. • Includes wiring and support bracket. • Light Support Bar required for installation. 		
Light Power Cable <i>(Not illustrated)</i>	Maverick X3, Maverick X3 MAX	715003417
<ul style="list-style-type: none"> • Required for installation of 10" (25 cm), 15" (38 cm) and Double Stacked LED Light Bars and 4" (10 cm) Round LED Lights. • For bumper and roof mounting locations. 		

AUDIO & COMMUNICATION SYSTEMS

Audio

Can-Am Audio Roof	Maverick X3	715007130
	<ul style="list-style-type: none"> • Full roof with sleek built-in audio. • Fully sealed and waterproof. • Easy to install: one wire connects the roof to the vehicle's electronics. • Four 8" speakers, one 400 RMS and 800 peak watt amplifier, and one Head Unit supplied by Rockford Fosgate Audio. 	<ul style="list-style-type: none"> • Multi-coloured RGB LED accent lighting around each speaker. • 2.7" colour display with Bluetooth and Pandora connectivity. • Flip Kit-compatible. • Not compatible with the Adventure Roof Rack if the Flip Kit is installed. • Not compatible with the Upper Soft Door Panels.
Can-Am Audio Roof	Maverick X3 MAX	715006709
	<ul style="list-style-type: none"> • Full roof with built-in audio. • Fully sealed and waterproof. • Easy to install, one wire connects the roof to the vehicle's electric system. • Six 8" Speakers, one 400 RMS and 800 Peak watt amplifier, one Head unit calibrated by Rockford Fosgate Audio. 	<ul style="list-style-type: none"> • Multi-coloured RGB LED accent lighting around each speaker. 2.7" • Colour Display with Bluetooth and Pandora connectivity. • Not compatible with the Adventure Roof Rack if the Flip Kit is installed. • Not compatible with the Upper Soft Door Panels.
Can-Am Audio Roof Flip Kit	Maverick X3, Maverick X3 MAX	715007131
	<ul style="list-style-type: none"> • Combines with Audio Roof 715007130 or 715006709 for Flip option. • Not compatible with the Racing Side Mirrors (715002898). 	
MTX Central Speakers	Maverick X3 MAX	715004748
	<ul style="list-style-type: none"> • Top mounted central speaker case holding two 6.5" (16.5 cm)/100W speakers. • Designed to be Can-Am-tough in the most demanding riding conditions. 	<ul style="list-style-type: none"> • Perfect add-on to the Complete MTX Audio System for a 7-speaker system or as a stand-alone system by plugging the AUX input jack directly into your music device. • Not compatible with Lonestar roofs.
Complete MTX Audio system	Maverick X3, Maverick X3 MAX	715002873
	<ul style="list-style-type: none"> • Bluetooth 5⁺ equipped 400 W RMS/800 W peak audio system by MTX. • Designed to be Can-Am-tough in the most demanding riding conditions. 	<ul style="list-style-type: none"> • Includes front-dashboard and rear-roll-cage mounted stereo speakers and head unit with an integrated 6.5" (16.5 cm) subwoofer. • Add the Electronic Device Holder to securely hold your Bluetooth device ready to play your favorite tunes.
Can-Am Subwoofer	Maverick X3, Maverick X3 MAX	715004956
	<ul style="list-style-type: none"> • Powerful Rockford Fosgate Underseat 10" Subwoofer speaker box. • Easy plug-and-play connections to Audio Roof system. • Sturdy construction tough enough to withstand harsh environments and sealed against moisture and dirt. 	<ul style="list-style-type: none"> • Requires 1 Amplifier kit (715007227) for 1 or 2 subwoofers. • Fits two per vehicle: under driver or passenger seat. • Wiring included.
Can-Am Amplifier kit	Maverick X3, Maverick X3 MAX	715007227
	<ul style="list-style-type: none"> • A powerful 400 W amplifier to feed up to two Underseat Subwoofers. • Easy plug-and-play connections to Audio Roof system and subwoofer. • Installation plate and wiring included. 	
Electronic Device Holder	Maverick X3, Maverick X3 MAX	715002874
	<ul style="list-style-type: none"> • A great in-ride entertainment system platform. • Robust injected-polypropylene construction allows for right fit and easy installation. • Adjustable unit safely holds most tablets and smartphones measuring between 5.1" (13 cm) and 10" (25.4 cm) (with protective case). 	<ul style="list-style-type: none"> • Combines seamlessly with Complete MTX Audio System and Rugged Radios Intercom System. • Allows the installation of Garmin Montana 680T GPS. • Integrated storage (1 gal [3.8 L] capacity) with access to the dash 12V outlet for device charging.

Communication Systems

Rugged Radios Car-to-Car System

Maverick X3, Maverick X3 MAX

715003440 · US ONLY



- Perfect for communicating with friends and family on group rides.
- Push-to-talk button conveniently mounted on the steering wheel.
- May be connected with the Rugged Radios Intercom System (with provided adapter cable).
- This kit includes:
 - 5-watt V3 radio: UHF/VHF + FM frequency, programmable channels, 5 watts of power, includes belt clip, recharging cable, high capacity, all day lithium-ion battery, 1-3 mile range, NOAA weather channels, 1-touch FM radio, backlit screen/buttons
 - Helmet speaker/mic kit: Clear Hear audio speakers, Full Flex mic boom, cloth mic cover, Velcro mount speakers, quick & easy install
 - Harness & cables: single person harness, driver coil cord PTT, waterproof PTT, radio mounting bracket, complete plug & play kit

Rugged Radios Intercom System

Maverick X3, Maverick X3 MAX

715002891 · US ONLY



- Specifically designed to facilitate clear in-vehicle communication between driver and passenger(s).
- Expandable to 4 people.
- Includes music port for enjoying your favorite tunes.
- Seamless integration with in-dash switch panel.
- May be synched with the Rugged Radios Car-to-Car System (715003440). Accessory not available in Canada.
- Power Cable is required for installation on MAX models.

Rugged Radios Helmet Headset Kit for Rear Passengers

With Rugged Radios Intercom System

715004380 · US ONLY



- Additional 12' (3.7 m) cables and Helmet Speaker/Mic Kits to upgrade your 2-person intercom system to a 4-person system.
- Power Cable is required for installation on MAX models.

ELECTRICAL & ELECTRONIC ACCESSORIES

Electrical

Seat Heater

Maverick X3, Maverick X3 MAX

715006112

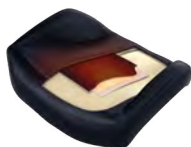

- 25 W seat heater delivers chill-free riding comfort.
- High/low temperature settings allow you to control the desired degree of warmth.
- This kit includes one carbon fiber seat heater, foam sheet and in-dash switch.
- Installs directly in the original seat cushion.
- Heated Accessories Wiring Harness (710005757) is required for front seat installation.
- Heated Accessories Wiring Harness (715006004) is required for rear seat installation.

Heated Visor Outlet

Maverick X3, Maverick X3 MAX

715001246



- Strategically positioned on vehicle to maintain your agility.
- Optional visor outlet that delivers fog-free riding.
- Quick and easy installation.
- Sold individually.
- Heated Visor not included.

Heated Accessories Wiring Harness

(Not illustrated)

Maverick X3, Maverick X3 MAX

710005757

- Electric harness required to hook up and operate front heated seats, heated steering wheel and heated grab bar.
- Heated Accessories Wiring Harness (715006004) is required for rear seat installation.

Auxiliary Battery Installation Kit

(Not illustrated)

Maverick X3, Maverick X3 MAX

715006315

- Allows you to add a second 18Ah battery for a dual battery setup necessary to power auxiliary electrical components such as sound systems or winches.
- Equipped with an IP67-rated waterproof electronic module that will prevent your auxiliary electrical components from draining your starting battery.
- Kit includes an additional battery junction block, all necessary wiring and the battery holder.
- Both batteries are perfectly integrated, in stock location, behind the passenger seat.
- Additional battery (410301203), plus battery hardware (250000282) sold separately.

Electronic Accessories

USB Power Outlet Kit

Maverick X3, Maverick X3 MAX

219400510



- Recharges your electronic devices while riding* (smartphone, MP3, heating gear, etc.).
- Dual port USB connectors.

*The power outlet is not capable of recharging all device types while riding.

Lighted Whip Flag

Maverick X3, Maverick X3 MAX

715002886



- A must for riding the dunes.
- 5 W Cree LED.
- 5 coloured lenses to allow personalization.
- Glow-through whip, quickly removable and replaceable pole.
- Increases vehicle's visibility.
- Meets most dune-area requirements.
- Die cast aluminum base, acetal hand nut.
- Includes mounting brackets and wiring.
- 4' (1.2 m) flag mounts on top of the roll cage.
- Can be installed on both sides of a vehicle.

Battery Charger/Maintainer

715005061



- Keeps stored lead-acid batteries charged.
- Charges and maintains small batteries.
- Microprocessor controlled multi-stage charging for added precision, safety and battery life.
- Automatically detects 6 or 12 volt batteries.
- Reverse hook-up protection helps protect battery and charger from damage.
- Auto-voltage detection.
- Press the display button to show the charge progress.
- Content: 3 amp battery charger, clamp adapter, DC adapter, 24" (61 cm) fused ring leads harness with weather cap, owner's manual.
- Not EC compliant.

Jump Starter

715005062



- IPX3 water-resistant and enclosed output ports.
- 4 LED battery indicators for easy read on battery charge level.
- Compact design, will conveniently fit in your backpack, glove box or any other storage compartment.
- 2.4A + 1A/5V USB ports for fast charging of all USB devices.
- Smart cable provides protection against reverse polarity, short circuit, low voltage, high temperature and reverse charging.
- Built-in LED light (3 modes).
- Content: 300CA jump starter, SA858 smart cable clamp, MC-USB to USB charging cable, travel bag, user manual.
- Not EC compliant.

Quick Connect Battery Cable

715005408



- Quickly and easily connect and charge different batteries with your charger.
- Included in the Battery Charger/Maintainer.
- Sold individually.

Quick Connect Cable with Battery Indicator

715006055



- Quickly and easily connect and charge different batteries with your charger.
- 3-colour LED indicator provides constant battery health indication.
- Sold individually.

Digitally Encoded Security System (D.E.S.S.) Green Key

Maverick X3 (Turbo/TurboR/Turbo RR motorization)

710005232



- Top-security anti-theft protection for your vehicle.
- Encrypted chip technology restricts access to your vehicle's electronic ignition system.
- One vehicle/one code.
- A vibration/shock-resistant ball-and-socket design that ensures a reliable connection.
- 3 programmable modes:
 - Work mode: Limits vehicle speed to 40 kph (25 mph) but does not limit engine torque.
 - Normal mode: Limits vehicle speed to 70 kph (44 mph) and 50% torque reduction.
 - Performance mode: No restrictions.

WINCHES & HITCHES

Can-Am HD Winches

Can-Am HD 4500 Winch

Maverick X3, Maverick X3 MAX

715006416



- Ergonomic clutch handle.
- Rugged all-steel gears and bushings for more torque and durability.
- Automatic 100% load-holding brake.
- Sealed solenoid for all-weather protection.
- Weather sealed corded remote and dash mounted switch.
- EC compliant.
- Pulling strength capability of 4,500 lb (2,041 kg).
- 43' of 1/8" (13.1 m of 6.3 mm) wire steel cable.
- Heavy-duty 4-way roller fairlead.
- Winch Electrical Harness (715003585) and winch compatible front bumper are required.

Can-Am HD 4500-S Winch

Maverick X3, Maverick X3 MAX

715006417



- Ergonomic clutch handle.
- Rugged all-steel gears and bushings for more torque and durability.
- Automatic 100% load-holding brake.
- Sealed solenoid for all-weather protection.
- Weather-sealed corded remote and dash mounted switch.
- Pulling strength capability of 4,500 lb (2,041 kg).
- 50' of 1/4" (15.2 m of 6.35 mm) synthetic rope.
- Corrosion-proof aluminum hawse fairlead.
- Winch Electrical Harness (715003585) and winch compatible front bumper are required.

WARN[†] VRX Winches

WARN VRX 45 Winch

Maverick X3, Maverick X3 MAX

715006110



- Extreme IP68-rated waterproof sealing keeps the elements out.
- Durable all-metal construction.
- Black powder-coated finish and stainless steel fasteners for corrosion resistance.
- Robust new clutch design based on 70+ years of WARN 4 WD hub lock know-how.
- Load-holding brake for great control.
- Smooth and reliable all-metal three-stage planetary gear train.
- Dash-mounted rocker control.
- Limited lifetime warranty (mechanical), 3-year warranty (electrical).
- Pulling strength capability of 4,500 lb (2,041 kg).
- 50' of 1/4" (15 m of 6.3 mm) wire steel cable.
- Roller fairlead.
- Winch Electrical Harness (715003585) and winch compatible front bumper are required.

WARN VRX 45-S Winch

Maverick X3, Maverick X3 MAX

715006111



- Extreme IP68-rated waterproof sealing keeps the elements out.
- Durable all-metal construction.
- Black powder-coated finish and stainless steel fasteners for corrosion resistance.
- Robust new clutch design based on 70+ years of WARN 4 WD hub lock know-how.
- Load-holding brake for great control.
- Smooth and reliable all-metal three-stage planetary gear train.
- Dash-mounted rocker control.
- Limited lifetime warranty (mechanical), 3-year warranty (electrical).
- Pulling strength capability of 4,500 lb (2,041 kg).
- 50' of 1/4" (15 m of 6.3 mm) synthetic rope.
- Cast aluminum hawse fairlead.
- Winch Electrical Harness (715003585) and winch compatible front bumper are required.

Winch Accessories

Can-Am HD Hawse Fairlead

Can-Am HD Winch

715006426



- A must when upgrading your winch with a synthetic cable, this corrosion-proof aluminum hawse fairlead will prevent the cable from snapping in a corner of a roller fairlead and from wearing prematurely due to the rough surface of the worn roller guide.
- Must be used with synthetic cables only.

WARN Hawse Fairlead

WARN Winch

715007785



- Double-powder-coated construction.
- Required to use the Synthetic Winch Cable (715001118) on WARN winches.
- To be used with synthetic winch cables only.

Synthetic Winch Cable

Can-Am HD Winch

715006430

WARN Winch

715007783



- 50' of 1/4" (15.2 m of 6.35 mm) synthetic cable for Can-Am HD winches.
- Can-Am HD Hawse Fairlead (715006426) is required when upgrading to a synthetic cable to avoid premature cable damage and wear.
- WARN Hawse Fairlead (715007785) is required when upgrading to a synthetic cable to avoid damage and premature wear of the cable.

Wire Rope Replacement	Can-Am HD Winch	705014978
	WARN Winch	715006699



- 43' of 15/64" (14.3 m of 6.3 mm) wire rope for Can-Am HD Winch.
- 55' of 1/4" (16.8 m of 6.35 mm) wire rope for WARN winch kit.
- 4,500 lb (2,041 kg) pulling strength.

Synthetic Cable Extension		715001120
----------------------------------	--	------------------



- Lightweight 1/4" (6.35 mm) diameter, easy to handle and won't rattle in cargo box.
- Easily attaches to winch cable to provide additional 50' (15.2 m) of distance.
- 4,500 lb (2,041 kg) single line capacity.

Winch Electrical Harness <i>(Not illustrated)</i>	Maverick X3, Maverick X3 MAX	715003585
---	------------------------------	------------------

- Required for winch installation.

Rear Winch Harness <i>(Not illustrated)</i>		715006007
---	--	------------------

- Required for installation of a winch on the S3 Rear Winch Bumper.

Wired Remote Control	Can-Am HD Winch†	715006504
-----------------------------	------------------	------------------



- This kit allows winch owners to add the hand-held remote to vehicles with a stock winch.
 - OEM stock winch is sold separately.
 - EC compliant.
- † Harness (710001023) is required to use remote control on a vehicle with a factory installed winch.
‡ Remote control (710007050) and connection socket are included.

Wireless Remote Control	WARN Winch	715002542
--------------------------------	------------	------------------



- The system is quick and easy to install, thanks to a wiring harness with an integrated antenna and all necessary mounting hardware.
- The system allows you to operate your winch from anywhere within a 50' (15.2 m) radius, increasing your recovery options.
- All components are weatherproof.

X rc/X mr Rear Tow Hook	Maverick X3, Maverick X3 MAX 2021 & prior	715004450
--------------------------------	---	------------------



- Offers a solid place to hook onto in case towing is needed.
- Allows you to attach most straps and hooks.
- Made of rugged 3/16" (5 mm) steel plate and 5/8" (16 mm) steel hook tube.
- Standard on Maverick X rc and X mr models.

Hitches

Rear Hitch	Maverick X3, Maverick X3 MAX 2021 & prior	715002883 · Black 715003938 · Can-Am Red
-------------------	---	---



- Rugged lightweight steel construction.
- E-coated finish.
- Fixed mounting point for trailer ball to provide vehicle with towing capabilities.
- This hitch offers 1,300 lb (590 kg) of towing capacity.
- Hitch ball not included.

Front and Rear Hitch Drawbar	Maverick X3, Maverick X3 MAX	715008350
-------------------------------------	------------------------------	------------------



- Standard on 2" (5 cm) receiver hitch.
- It offers 1,650 lb (750 kg) of towing capacity.
- Hitch ball not included.
- Forged steel.

PERFORMANCE

Smart-Lok Technology

Smart-Lok Differential	Maverick X3 produced after January 1, 2017 Maverick X3 MAX	705402936
-------------------------------	---	------------------



- Can-Am-exclusive Smart-Lok technology constitutes a true fully lockable on-the-fly front differential with electronically controlled automatic modes.
- Choose your differential settings according to your riding need: "2x4" for rear wheel traction only, "4x4 Front Diff Lock" for a fully locked 4 wheel drive, and "4x4 Smart Mode" that offers preset, intelligent calibrations for your type of riding.
- Using multiple input sources, "Smart Mode" will instantaneously engage locking with the right load at the right moment to procure maximum traction while retaining low-speed maneuverability, allowing for optimal placement and a feeling of confidence.
- The Smart-Lok Differential Kit comes standard with the Trail Mode.
- Mud, Rock and Trail Activ modes can be added by installing an additional Smart Mode Module (sold separately) to fine-tune your riding environment.
- Requires Performance Half Shafts (2x) and Smart-Lok Installation Kit for installation.

Performance Half Shaft	Maverick X3, Maverick X3 MAX	705401634 · 64"
	Maverick X3, Maverick X3 MAX	705402048 · 72"



- High-performance design ideal for off-road use, with superior protection in any riding usage.
- Includes CVs, shaft and boots with the best suited geometry for your Can-Am vehicle.
- Required to install the Smart-Lok Differential Kit.

Mud Smart Mode Module <i>(Not illustrated)</i>	Maverick X3, Maverick X3 MAX with Smart-Lok Differential (except Turbo RR models 2021 & up)	715005282
--	--	------------------

- This module allows you to add the Mud Smart Mode to vehicles with the Smart-Lok Differential Kit sold as an accessory or to change to the Mud Smart Mode on vehicles equipped with a standard Smart-Lok.
- The Mud Mode has been specially designed to deliver superior traction in the deepest mud holes.
- When high engine torque and/or slippage is detected, Smart-Lok will fully lock the front end.
- The system will stay locked until throttle release.
- Only one Smart Mode Module can be installed at a time.

Rock Smart Mode Module <i>(Not illustrated)</i>	Maverick X3, Maverick X3 MAX with Smart-Lok Differential (except Turbo RR models 2021 & up)	715005283
---	--	------------------

- This module allows you to add the Rock Smart Mode to vehicles with the Smart-Lok Differential Kit sold as an accessory or to change to the Rock Smart Mode on vehicles equipped with a standard Smart-Lok.
- The Rock Mode has been specially designed to help cross challenging rocks.
- When high engine torque is detected at low vehicle speed, Smart-Lok will progressively lock the front end and will stay engaged until throttle release to prevent wheel slippage and provide optimal traction.
- The progressive engagement allows for easier steering when maneuvering the vehicle.
- Only one Smart Mode Module can be installed at a time.

Trail Activ Smart Mode Module <i>(Not illustrated)</i>	Maverick X3, Maverick X3 MAX with Smart-Lok Differential (except Turbo RR models 2021 & up)	715005284
--	--	------------------

- This module allows you to add the Trail Activ Smart Mode to vehicles with the Smart-Lok Differential Kit sold as an accessory or to change to the Trail Activ Smart Mode on vehicles equipped with a standard Smart-Lok.
- The Trail Activ mode has been designed for aggressive riding, delivering the ultimate cornering precision.
- When high engine torque and/or an increase in vehicle speed is detected, Smart-Lok will progressively engage the front end and maintain it engaged until throttle release or vehicle speed reduction.
- The progressive engagement allows for smoother and lower steering effort.
- Only one Smart Mode Module can be installed at a time.

Lonestar Racing Mud Flaps with Brackets	Maverick X3, Maverick X3 MAX	715004865
--	------------------------------	------------------



- These bolt-on mud flaps make a great addition.
- Durable chromoly brackets.
- Protect trailing arms, rotors and CVs from rocks and debris.
- Sold in pairs.

Lonestar Racing Heavy-Duty Shift Plate & Knob	Maverick X3, Maverick X3 MAX	715004866
--	------------------------------	------------------



- The shift plate is made from durable stainless steel and bolts into place for a secure fit.
- The kit comes with a billet aluminum Lonestar Racing shift knob.
- Offers improved durability for the performance-oriented driver.

Lonestar Racing Outer Toe Link Boxed Gussets Roller Fairlead	Maverick X3, Maverick X3 MAX 2021 & prior	715004868
---	---	------------------

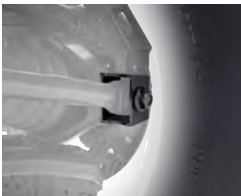

- Protects and strengthens the middle radius rod links from rough riding conditions.
- Includes high-grade steel bolts.

Lonestar Racing Quick Release Clutch Cover Pins	Maverick X3, Maverick X3 MAX	715005045
--	------------------------------	------------------



- This kit will allow you to take off your clutch cover in seconds to access the belt tool-lessly.
- Includes 4 stainless steel "quick release" pins with clips and tethers.
- Replaces all clutch cover screws.
- This product affects the clutch cover sealing. It is highly recommended to use this product under dry riding conditions only.

Lonestar Racing Heavy-Duty Rear Boxed Radius Rod Support Plate	Maverick X3, Maverick X3 MAX 2021 & prior	715005046
---	---	------------------



- Double-layered radius rod support plate made of high-grade steel.
- Reinforces your rod mounting location on the frame while adding a mean racing look to your vehicle.
- Easy to install.

X rc Brake Pedal	Maverick X3, Maverick X3 MAX	715004901
-------------------------	------------------------------	------------------



- Brake pedal with larger foot surface.
- This improves ergonomics and control for the rider in rock climbing conditions.

Yoshimura† Slip-on Exhaust	Maverick X3, Maverick X3 MAX	715002882
-----------------------------------	------------------------------	------------------



- Developed in collaboration with Yoshimura.
- Made from 304-grade stainless steel with brushed aluminum tip.
- Better sounding, better looking and 19% lighter than stock muffler.
- USDF/USDA approved spark arrester.
- Fuel injection system tuning not required.
- ROHVA and EPA compliant.
- Not EC compliant.

Performance Air Filter by Twin AIR†	Maverick X3, Maverick X3 MAX	715002895
--	------------------------------	------------------





- The best choice for the harshest conditions.
- Multiple staged oiled filtering foam for superior dust retaining capacity with high airflow.
- Washable and reusable.

Foam Replacement <i>(Not illustrated)</i>	Maverick X3, Maverick X3 MAX	715000713
---	------------------------------	------------------

- Replacement foam for Performance Twin Air Filter.

Snorkel Pre-filter	Maverick X3, Maverick X3 MAX (with Snorkel Kit)	715005599
	<ul style="list-style-type: none"> • Pre-filter specifically for snorkels. • Adds extra protection to your engine in harsh riding conditions. • Helps keep air filter cleaner. • Filter blocks particles larger than 0.005" (0.13 mm). • Necessary to maintain vehicle warranty when tracks are installed. 	

Snorkel Kit	Maverick X3, Maverick X3 MAX (2019 and prior)	715003733
	Maverick X3, Maverick X3 MAX (2020 & up)	715007110
	<ul style="list-style-type: none"> • Raises point of engine and CVT air intakes so vehicle can be semi-submersed in water or mud without the engine taking in water. • Not compatible with S&B Particle Separator, LinQ Pivoting Rack, Lonestar Racing Rear Intrusion Bar or any rear panels or windows. 	<ul style="list-style-type: none"> • Sealed Air Box 707800780 (sold separately) is required for installation on models manufactured before January 1, 2018. • Standard on Maverick X3 X mr models. • Not EC-compliant.

Radiator Relocator	Maverick X3, Maverick X3 MAX	715004937
	<ul style="list-style-type: none"> • Relocates stock radiator to rear of cage. • Protects it from debris and rocks. • Prevents cooling performance loss in muddy conditions. • Reduces hot air in the cabin. • Easy to clean. • Includes support hardware and hoses. 	<ul style="list-style-type: none"> • Not compatible with any bed accessories, Rear Cage mounted accessories, Complete MTX Audio system and Upper Soft Doors (except LinQ 8 gal [30 L] Cooler Box). • Radiator (709200703) is required for installation on 2017 models. • Not compatible with full windshield.

WARNING: Any modifications or addition of accessories may affect the handling of your vehicle. It is important to take the time to get familiar with the vehicle once modifications are made to understand how to adapt your driving behavior accordingly. Do not tamper with unauthorized modifications or install equipment not specifically certified by BRP for the vehicle. These modifications have not been tested by BRP and they may increase the risk of injury or loss of control, or render the vehicle illegal to ride. Ask your authorized BRP dealer for suitable available accessories for your vehicle.

Arched Lower Suspension Links	Maverick X3, Maverick X3 MAX	715005065 · 64" models
		715005066 · 72" models
	<ul style="list-style-type: none"> • Arched lower links to free up more ground clearance. • Standard on X mr and 2022 X rc models only. 	

850 W Magneto Kit	Maverick X3, Maverick X3 MAX (2021 & up)	715006279
	<ul style="list-style-type: none"> • Increases the magneto output to 850 W. • Includes rotor, stator and regulator. 	

High Output 172 HP Upgrade Kit X3	Maverick X3, Maverick X3 MAX (2017 models)	715004700
	<ul style="list-style-type: none"> • Performance upgrade kit for Maverick X3 2017 models only. • Gain 18 HP for a total of 172 HP. • Includes: intercooler with fan, fuel pump catalyst and high performance belt. • Installation must be done by an authorized BRP dealership to preserve the vehicle's warranty. • C.A.R.B. Executive Order #D-799U. 	

172 HP Intercooler Upgrade Kit <i>(Not illustrated)</i>	Maverick X3, Maverick X3 MAX (2018 and 2019)	715007137
	Maverick X3, Maverick X3 MAX (2020)	715007277
	<ul style="list-style-type: none"> • Intercooler upgrade for the Maverick X3 2018 & up. • Installation must be done by an authorized BRP dealership to preserve the vehicle's warranty. • Requires the power upgrade installation kit (715007111). 	

Power Upgrade Installation Kit <i>(Not illustrated)</i>	Maverick X3, Maverick X3 MAX (2018-2020)	715007111
		<ul style="list-style-type: none"> • Increases the power of the Maverick X3 from 120 HP to 172 HP. • Includes fuel pump, clutch components and turbo adjustment. • Installation must be done by an authorized BRP dealership to preserve the vehicle's warranty. • Requires Maverick X3 intercooler specific to model year (715007137 or 715007277).

WARNING: Any modifications or addition of accessories may affect the handling of your vehicle. It is important to take the time to get familiar with the vehicle once modifications are made to understand how to adapt your driving behavior accordingly. Do not tamper with unauthorized modifications or install equipment not specifically certified by BRP for the vehicle. These modifications have not been tested by BRP and they may increase the risk of injury or loss of control, or render the vehicle illegal to ride. Ask your authorized BRP dealer for suitable available accessories for your vehicle.

Emergency Accessories

Lonestar Racing Fire Extinguisher Support

Maverick X3, Maverick X3 MAX

715003734



- Quick-release support that allows you to slide the fire extinguisher out in a matter of seconds in an emergency situation.
- Made of billet anodized black aluminum.
- Provides you with the safety and security of having dependable emergency equipment on board.
- Fits 1.85" (4.7 cm) tubing.
- Can be fixed everywhere on the cage.
- Comes with both billet mounts, quick-pull pin, mounting plate and 2 clamps.
- Fire extinguisher sold separately.
- "Lonestar Racing for Can-Am" branded.

Fire Extinguisher

295100833



- Ideal for grease, oil and electrical fires.
- Fits with Lonestar Racing Fire Extinguisher Support Kit.
- Not EC compliant.

Emergency Kit

Maverick X3, Maverick X3 MAX

715006102



- Complete emergency kit provides all essential equipment and supplies to get out of most unfavorable situations powersport enthusiasts can find themselves in.
- Includes: jumper cables, air compressor, tyre repair kit, ratchet tie-down, duct tape, 3,300 lb (1,500 kg) tow strap, zip-ties, cloth rags

TRAILERING

Trailering Cover

(Not illustrated)

Maverick X3

715005813

Maverick X3 MAX

715005814

- Heavy-duty canvas made of UV-resistant solution-dyed polyester.
- Inner soft liner protects windshield and coloured panels from abrasion.
- All high-abrasion areas are reinforced with a double canvas layer.
- Weather-resistant trailering cover protects your vehicle during storage and transportation.
- Opening for fuel cap and cabin access on passenger side.
- Quick and easy installation.
- Designed to perfectly fit your vehicle with or without Can-Am accessories.

Bolt-On† Retractable Ratcheting Tie-Downs

295101072



- Perfect for transporting your powersport vehicle or securing loads.
- Mounts easily: bolts on any flat surface (e.g., truck bed or frame).
- 1" x 6' (2.5 cm x 1.8 m) tie-down strap with heavy-duty stitching that delivers a 500 lb (226 kg) working load strength and 1,500 lb (680 kg) break strength.
- Convenient retractable push button automatically slackens, spools and stores away strap, while the ratchet mechanism tightens the strap snugly to secure your vehicle or load into place.
- Rubber ratcheting handle provides firm grip, and the hook is vinyl coated to protect whatever surface it hooks into.
- Sold in pairs.

Ratchet Tie-Downs

715008309 · Black/Gray



- 400 lb (181 kg) safe working load.
- 1" x 10' (2.5 cm x 3 m) strap with Sea-Doo, Ski-Doo and Can-Am logos.
- Deluxe ratchet with rubber handle.
- Coated S hooks.
- Pack of 2.

Heavy-Duty Ratchet Tie-Down

715008308



- 1,000 lb (454 kg) safe working load.
- 1.5 in. x 6 in. (38 mm x 1.8 mm) strap with BRP brands.
- Deluxe ratchet with rubber handle.
- Black-coated clip hooks.
- 12" (300 mm) webbing included.
- Pack of two.

APACHE TRACK SYSTEMS

Winter Tracks

Limited Warranty*

Apache Backcountry LT Track System

Maverick X3, Maverick X3 MAX

715004734



- Tracks designed to deliver the best snow performance on the market with unmatched flotation level and traction on snow surface.
- Large contact patch, 37% bigger than the Apache 360 LT.
- Impressive added ground clearance of 7" (18 cm) helps keep the vehicle over the snow.
- Lightweight snowmobile-inspired rail design.
- Aggressive track design with 2" (5 cm) lug height for maximum traction on snow.
- Apache Backcountry LT Mounting Kit, Track DPS Module and Engine and CVT Pre-Filter are required.
- Fine-tune your track system using extra Idler Wheels, Sliders with Vespel Inserts and Rail Ice Scratcher.
- For winter use only.
- Track installation will affect vehicle width and length.

Apache Backcountry LT Mounting Kit

(Not illustrated)

Maverick X3, Maverick X3 MAX

715004397 · 64" models

715004394 · 72" models

- Required for installation of the Apache Backcountry Track LT System.
- DPS module and Pre-Filter are required and sold separately.

Year-Round Tracks

Limited Warranty*

Apache 360 LT Track System

Maverick X3, Maverick X3 MAX

715005103



- Multifunctional tracks designed to support heavy loads and to fit on most Can-Am off-road vehicles.
- Extra contact patch adjustment for better performance over rough terrain.
- Contact patch is 7% to 9% bigger than the Apache 360's.
- Average ground clearance of 16" (41 cm).
- 1" (2.5 cm) lugs in the front and 1.25" (3.2 cm) in the back.
- Apache 360 LT Mounting Kit, Track DPS Module and Engine and CVT Pre-Filter Kit are required.
- EC compliant.

Apache 360 LT Mounting Kit

(Not illustrated)

Maverick X3, Maverick X3 MAX

715004392 · 64" models

715004393 · 72" models

- Required for installation of the Apache 360 LT Track System.
- Track DPS Module and Pre-Filter not included.

APACHE TRACK SYSTEMS FITTING GUIDE

Apache Backcountry LT

Model Year / Model	Track	Track Mount	Track DPS Module	Prefilter without Snorkel	Prefilter with Snorkel
2017 & Up Maverick X3, Maverick X3 MAX (64" Models)	715004734	715004397	715007338 Maverick X3, Maverick X3 Max 2022 & prior (except Turbo RR engine) OR	715005600 (except X mr)	715005599
2017 & Up Maverick X3, Maverick X3 MAX (72" Models)		715004394	715006266 Maverick X3, Maverick X3 Max 2023, and 2022 & prior with Turbo RR Engines		

Apache 360 LT

Model Year / Model	Track	Track Mount	Track DPS Module	Prefilter without Snorkel	Prefilter with Snorkel
2017 & Up Maverick X3, Maverick X3 MAX (64" Models)	715005103	715004392	715007338 (except Turbo RR engine) OR	715005600	715005599
2017 & Up Maverick X3, Maverick X3 MAX (72" Models)		715004393	715006266 (Turbo RR engine only)		

*The limited warranty is subject to the exclusions, limitations of liabilities and all other terms and conditions of BRP's standard limited warranty.

Accessories

Rail Ice Scratchers

Apache Backcountry LT Track System

860201728



- Provide additional lubrication in hard and icy conditions.
- Rail mounted, small, light.
- Design expands on coil concept to allow reversing without damage.
- Easily stored when not in use.
- Extends slider life.

Apache Backcountry LT Wheel Kit

Apache Backcountry LT Track System

715006293



- Additional wheel kit for Backcountry LT rear tracks.
- Reduces drag and rolling resistance in hard snow conditions or when transporting heavier loads.
- Extends slider life in hard snow conditions.
- Includes two wheels, cross shaft and mounting hardware per kit to service one track corner.
- Up to two kits per rear track can be installed.

Sliders with Vespel[†] Inserts

Apache Backcountry LT Track Systems

503194815



- Use DuPont Vespel inserts for less friction.
- Longer life.
- Can be cut to desired length.
- 8 needed per vehicle.
- Sold individually.

Track DPS Module

(Not illustrated)

Maverick X3, Maverick X3 MAX (Turbo RR engine only)

715006266

Maverick X3, Maverick X3 MAX (except Turbo RR engine)

715007338

- Innovative DPS module that ensures speedometer accuracy and optimized steering assist, making for perfect track control and riding ease.
- Required to install the Apache Track Systems.

Engine & CVT Air Intake Pre-Filter

Maverick X3, Maverick X3 MAX (except X mr models)

715005600



- Adds extra protection to your engine in harsh riding conditions.
- Helps keep air filter cleaner.
- Filter blocks particles larger than 0.007" (0.19 mm).
- Easy installation.
- Not compatible with S&B Particle Separator.
- Necessary to maintain vehicle warranty when tracks are installed.

Required to install the Apache Backcountry LT and Apache 360 LT Track Systems.

Snorkel Pre-Filter

Maverick X3, Maverick X3 MAX (with Snorkel Kit)

715005599



- Pre-filter specifically for snorkels.
- Adds extra protection to your engine in harsh riding conditions.
- Helps keep air filter cleaner.
- Filter blocks particles larger than 0.005" (0.13 mm).
- Necessary to maintain vehicle warranty when tracks are installed.

Required to install the Apache Backcountry LT and Apache 360 LT Track Systems.

PROMOUNT PLOWS

Can-Am ProMount Steel Plow Kits

Can-Am ProMount Steel 72" (183 cm) Plow Kit

Maverick X3, Maverick X3 MAX

■ **715008176** · Black
■ **715008177** · Yellow



- These kits include:
 - Can-Am ProMount Steel Blade
 - Push Frame with Quick-Attach System
 - Can-Am ProMount Mounting Plate

Can-Am ProMount Steel Blades

Can-Am ProMount Steel 72" (183 cm) Blade

Fits ProMount Push Frame

■ **715004474** · Black
■ **715006021** · Yellow



- Plow blade made from 12-gauge steel.
- Replaceable wear blade.
- Large pin designed for easy blade rotation to eliminate snow buildup at pivot point.
- Blade design provides best snow roll-off at any angle.
- Clears 66" (168 cm) when plow is fully angled.
- Blade height of 17" (43 cm).
- Compatible with Can-Am ProMount Blade accessories to further enhance plow versatility.
- Not compatible with S3 High Clearance Front A-Arm.

Can-Am ProMount Angle Plows

Can-Am ProMount 72" (183 cm) Steel Oneway State Blade

Fits ProMount Push Frame

715007264



- Make the job easier with the right tools, clear long alleys and make the task easier by sending the snow further out of the way.
- Wing end of plow measures 26" (67 cm) high and tapers down to 16" (41 cm).
- One-way "winged" state plow designed to throw snow higher.
- Rubber flap (715007299) designed to keep snow away from the driver is offered as accessory (sold separately).
- Can-Am branded.

Can-Am ProMount Flex2 Plow Kit

Can-Am ProMount Flex2 72" (183 cm) Blade

Maverick X3, Maverick X3 MAX

715008175



- These kits include:
 - Can-Am ProMount Flex2 Blade
 - Push Frame with Quick-Attach System
 - Can-Am ProMount Mounting Plate

Can-Am ProMount Flex2 Blades

Can-Am ProMount Flex2 72" (183 cm) Blade

Fits ProMount Push Frame

715004485



- Plow blade made of UHMWPE, flexible and impact absorbing material prevents damaging your plow when accidental impact occurs.
- Replaceable wear blade.
- Large pin designed for easy blade rotation to eliminate snow buildup at pivot point.
- Blade design provides best snow roll-off at any angle.
- Clears 66" (168 cm) when plow is fully angled.
- Blade height of 17" (43 cm).
- Compatible with Can-Am ProMount Blade accessories to further enhance plow versatility.

Can-Am ProMount Plow Accessories

Can-Am ProMount Edge Markers

Maverick X3, Maverick X3 MAX

715004206



- Help locate the edges of your plow.
- Height: 24" (60 cm).
- Sold in pairs.
- Compatible with Can-Am ProMount Steel and Flex2 Blades with or without Blade Extensions (except for the Can-Am ProMount Steel 54" (137 cm) Blades).

Can-Am ProMount 72" (183 cm) Plastic Wear Blade

Maverick X3, Maverick X3 MAX

715004483



- Ideal to prevent leaving marks on your driveway.
- Compatible with Can-Am ProMount 72" (183 cm) Blades.

Can-Am ProMount Drift Cutters

Maverick X3, Maverick X3 MAX

715006258

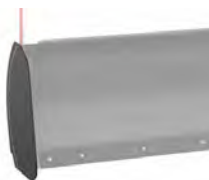

- Help keep snow in the plow.
- Dimensions: 17" x 13" (43.2 cm x 33 cm).
- Sold in pairs.
- Compatible with Can-Am ProMount Steel and Flex2 blades with or without Blade Extensions (except for the Can-Am ProMount Steel 54" (137 cm) Blades).

Can-Am ProMount Blade Extensions

Maverick X3, Maverick X3 MAX

■ 715004205 · Black
■ 715005319 · Yellow



- These conveniently extend your Can-Am ProMount Blade.
- Add 3" (8 cm) each side.
- Compatible with Can-Am ProMount Blades (except for the Can-Am ProMount Steel 54" (137 cm) Blades).
- Longer Wear Blade can be installed to go over the extra length given by the extensions.

Back Drag Blade

(Not illustrated)

ProMount Plows (60" and more)

715007794

- ¼ thick steel swivel scraper.
- Lifts up when the vehicle is moving forward so as not to affect the scraping.
- Increased capacity to pull snow.
- More aggressive scraping in reverse mode.
- Lifts the scraper off the ground so that it scrapes evenly.
- Adjustable in length for compatibility with 60", 66" and 72" blades.
- Compatible with ProMount blades (Flex and Steel).
- Not compatible with Backcountry Track Kit.

Curved Wear Blade

(Not illustrated)

Maverick X3, Maverick X3 MAX

715007793 · 72" (183 cm)

- Wear blade designed with a folded back bottom lip.
- The increased surface allows for less digging while plowing uneven surfaces.
- Ideal for snow covered gravel, grass, paver stone and other soft surfaces.

* Price subject to change

Can-Am ProMount Custom Solutions

Can-Am ProMount Push Frame with Quick-Attach System

Maverick X3, Maverick X3 MAX

715008116



- Heavy-duty steel tubes designed to withstand the roughest use.
- Mid-mount carriage provides ultimate push strength and traction.
- Designed for maximum plow lift height.
- Features a self aligning quick-attach system, an easy foot release pedal and an ergonomic handle for plow angle adjustment.
- Plow Limit Switch recommended to extend winch cable lifespan.
- Can-Am ProMount Mounting Plate required for installation.
- Blade swivels left or right, 5 positions.
- Large pin designed for easy blade rotation to eliminate dirt and snow buildup at pivot point.
- Plow Roller Fairlead included.

Can-Am ProMount Push Frame Extension

Maverick X3, Maverick X3 MAX

715006257



- 12" (30 cm) push frame extension required when plow is installed with Apache Track systems.

Can-Am ProMount Mounting Plate

Maverick X3, Maverick X3 MAX

715008197



- Required to install the Can-Am ProMount Push Frame with Quick-Attach System.
- Mounting plate precision designed to stay on year round without compromising ground clearance.
- Comes with the Plow Roller Fairlead.
- Not compatible with S3 High Clearance Front A-Arm.

Can-Am ProMount Plow Angling System

Maverick X3, Maverick X3 MAX

715006022



- Converts your plow system into an easy-to-control unit from the driver's seat.
- Allows you to have full up/down and left/right plow control at your fingertips by using the supplied joystick.
- Using one hand to control all plow motions will allow you to easily concentrate and manage your plowing tasks.
- Not compatible with Apache Backcountry LT Track System.
- Winch and plow sold separately.

ProMount Plow Limit Switch

(Not illustrated)

Maverick X3, Maverick X3 MAX

715006259

- For controlling the cable tension when over-raising your plow system.
- Prevents winch, plow push frame and vehicle damage.
- Sensor relocated for optimal lift height.

Plow Roller Fairlead

Maverick X3, Maverick X3 MAX

715001223

• Cylindrical Roller Fairlead



- Larger diameter lower roller reduces wear on wire rope for plow application.
- Can be used with all ProMount plows.

ProMount Plow Kits – Reference Charts

	72" Black Steel	72" Yellow Steel	72" Flex2
Plow Kit	715008176	715008177	715008175
Blade	715004474	715006021	715004485
Push Frame	715008116	715008116	715008116
Mounting Plate	715008197	715008197	715008197

TYRES & RIMS

Tyres

705402080 · Front

705502603 · Rear

705402168 · Front · 

705502665 · Rear · 

Maxxis[†] Bighorn 2.0 Tyre



- Front · 28" x 9" x 14".
 - Rear · 28" x 11" x 14".
- Compliant with European class T regulations.
- Front · 27" x 9" x 14".
 - Rear · 27" x 11" x 14".

Maxxis Liberty Tyre

Maverick X3 X rc

705402143 · Front

705402464 · Rear



- Engineered for performance driving and to give you and your side-by-side freedom in a variety of terrains.
- 8-ply radial construction.
- Front: 30" x 10" x 14".
- Rear: 32" x 10" x 15".

Maxxis Carnivore Tyre

Maverick X3 (except X mr, X rc & X rs models)

705402960 · 30"

705402961 · 32"



- The Carnivore boasts a gnarly tread design that delivers excellent traction on rocks, roots, desert terrain, and mud. The Carnivore is designed to conquer a wide variety of terrains.
- Aggressive all-terrain tread pattern.
- 8-ply-rated radial construction.
- Front & Rear · 30" or 32" x 10" x 14".

Maxxis Bighorn X ds Tyre

(Not illustrated)

705402081 · Front

705502604 · Rear

- Front · 29" x 9" x 14".
- Rear · 29" x 11" x 14".

Maxxis Bighorn X rs Tyre

(Not illustrated)

705402082

- Front & Rear · 30" x 10" x 14".

Rims

14" Maverick X3 X mr Rim

Maverick X3, Maverick X3 MAX

705402256



- Black with clear coat aluminum rim.

14" Maverick X3 Beadlock Rim

Maverick X3, Maverick X3 MAX

■ 705402207
• Black and machined
■ 705402173 · Black



- Black aluminum rim with machined face and clear coat.
- Choice of beadlock colour (not included).
- Needs 16 bolts (250000893) for installing the beadlock.

14" Maverick X3 Rim

Maverick X3, Maverick X3 MAX

705401965 · Front

705502493 · Rear



- Black with clear coat aluminum rim.
- Front: 14" x 7" Offset = 55 mm.
- Rear: 14" x 8" Offset = 76 mm.

14" Maverick X3 Beadlock Rim

Maverick X3, Maverick X3 MAX

705402393 · Front

705502814 · Rear



- Black with clear coat aluminum rim.
- Choice of beadlock colour.
- Needs 16 bolts (250000893) for installing the beadlock.
- Front: 14" x 7" Offset = 55 mm (For Xrs = Front and rear).
- Rear: 14" x 8" Offset = 76 mm.

14" Maverick X3 Beadlock Ring

Maverick X3 & Maverick X3 MAX (X rs, X ds models only)

■ **705401709** · Black

■ **705401913** · Gold

■ **705402358** · Can-Am Red

■ **705402472** · Manta Green



- Cast aluminum beadlock.
- Must be installed on Front Rim (705402393) and Rear Rim (705502814).



CAN-AM COMMANDER

CAN-AM COMMANDER

MODEL PACKAGES

Can-Am Commander DPS 700	117
Can-Am Commander X-T 1000R	118
Can-Am Commander MAX X-TP 1000R	119

COMPARATIVE CHART

Can-Am Commander Lineup	120
-------------------------	-----

ACCESSORIES

Roofs	122
Soft Cab Enclosure	123
Windshields & Wind Protection	123
Doors	126
Mirrors	127
Commander Skid Plates	128
Maverick Trail & Sport Skid Plates	129
Bumpers & Guards	130
Seat Accessories	135
LinQ: Easy On, Easy Off Cargo	136
Cargo & Storage	141
Racks & Holders	143
Lights	146
Audio & Communication Systems	150
Electrical & Electronic Accessories	151
Winches & Hitches	154
Performance	157
Apache Track Systems	159
ProMount Plows	161
Trailerling	165
Tyres & Rims	165



WHAT'S NEW

New Premium Colouration

Desert Tan:

Commander MAX XT-P package

Image for visual purposes only. Package shown not available in region.

2023 CAN-AM COMMANDER DPS 700



Tundra Green / 700

ENGINE	700
Type	52 hp/41 lb-ft, Rotax® ACE (Advanced Combustion Efficiency) 650 cc single cylinder, liquid-cooled
Fuel Delivery System	Intelligent Throttle Control (ITC™) with Electronic Fuel Injection (EFI)
Transmission	pDrive primary CVT with engine braking and Electronic Drive Belt Protection L/H/N/R/P
Drive Train	Selectable Turf Mode/2WD/4WD with Visco-Lok ¹ QE auto-locking front differential
Driving Assistance	Electronic Hill Descent Control SPORT/ECO™ modes
Power Steering	Dynamic Power Steering (DPS™)

SUSPENSIONS

Front Suspension	Double A-arm with sway bar/12.5 in. (31.8 cm) travel
Front Shocks	Twin-tube gas-charged shocks
Rear Suspension	TTA with sway bar/13 in. (33 cm) travel
Rear Shocks	Twin-tube gas-charged shocks

TYRES & WHEELS

Front Tyres	XPS Trail Force 27 x 9 x 14 in.
Rear Tyres	XPS Trail Force 27 x 11 x 14 in.
Wheels	14 in. steel

BRAKES

Front	Dual 220mm disc brakes with hydraulic twin-piston calipers
Rear	Dual 220mm disc brakes with hydraulic twin-piston calipers

PACKAGE HIGHLIGHTS

- Premium half doors
- Puncture resistant 8 ply tyres
- D.E.S.S.™ Key with speed limiting capabilities
- Full Skid Plate
- Rear Differential with Turf mode
- Sport Performance with Utility style tipping tray

DIMENSIONS & CAPACITIES

Estimated Dry Weight	1,530 lb (694 kg)
Chassis/Cage	Profiled cage, ROPS approved
L x W x H	128.5 x 62 x 70.5 in. (326.4 x 157.5 x 180.2 cm)
Wheelbase	90.6 in. (230.1 cm)
Ground Clearance	12.5 in. (31.8 cm)
Cargo Box Dimensions	29.5 x 45.2 x 10.6 in. (75.1 x 114.7 x 27 cm)
Cargo Box Capacity	600 lb (272.2 kg)
Towing Capacity	2,000 lb (907.2 kg)
Payload Capacity	1,030 lb (467.2 kg)
Storage Capacity	Total: 7.3 gal (27.6 L)
Fuel Capacity	10 gal (38 L)
Person Capacity	2

FEATURES

Gauge	4.5 in. wide digital display
Instrumentation	DC outlet (10-A)
Anti-theft System	RF Digitally Encoded Security System (D.E.S.S.™) with Start/Stop button
Magneto	650 W
Lighting	Front lighting output 110 W LED tail lights
Winch	N/A
Steering Wheel	Adjustable tilt steering
Protection	Premium half doors, Full skid plate, Mudguards
Hitch Type	2 in. hitch receiver

WARRANTY & EXTENDED SERVICE

Factory Warranty	2 years / 15,000 km, whichever comes first
Service Intervals	200 hours / 12 months / 3000 km

2023 CAN-AM COMMANDER XT 1000R



Oxford Blue / 1000R

ENGINE	1000R
Type	100 hp, Rotax® 976 cc, V-twin, liquid-cooled
Fuel Delivery System	Intelligent Throttle Control (ITC™) with Electronic Fuel Injection (EFI)
Transmission	Quick Response System (QRS) CVT with high-airflow ventilation, and Electronic Drive Belt Protection Extra-L/H/N/R/P
Drive Train	Selectable Turf Mode/2WD/4WD with Visco-Lok® QE auto-locking front differential
Driving Assistance	Electronic Hill Descent Control SPORT/ECO™ modes
Power Steering	Dynamic Power Steering (DPS™)

SUSPENSIONS	
Front Suspension	Arched double A-arm with sway bar/15 in. (38.1 cm) travel
Front Shocks	Twin-tube gas-charged shocks
Rear Suspension	Arched TTA with sway bar/15 in. (38.1 cm) travel
Rear Shocks	Twin-tube gas-charged shocks

TYRES & WHEELS	
Front Tyres	XPS Trail King 28 x 9 x 14 in.
Rear Tyres	XPS Trail King 28 x 11 x 14 in.
Wheels	14 in. cast-aluminum

BRAKES	
Front	Dual 220mm disc brakes with hydraulic twin-piston calipers
Rear	Dual 220mm disc brakes with hydraulic twin-piston calipers

PACKAGE HIGHLIGHTS

- 28 in. XPS Trail King tyres
- 64 lb. wide with high clearance Arched A-Arms
- 7.6 in. digital display with keypad
- Can-Am LED signature lights
- 14 in. cast-aluminium wheels
- XT front bumper
- 4,500 lb (2,014 kg) winch
- Full roof
- Premium half doors
- Puncture resistant 8 ply tyres
- D.E.S.S.™ Key with speed limiting capabilities
- Full Skid Plate
- Rear Differential with Turf mode
- Sport Performance with Utility style tipping tray

DIMENSIONS & CAPACITIES	
Estimated Dry Weight	1,675 lb (759.8 kg)
Chassis/Cage	Profiled cage, ROPS approved
L x W x H	130 x 64 x 74 in. (330.2 x 162.6 x 188 cm)
Wheelbase	90.6 in. (230.1 cm)
Ground Clearance	13 in. (33 cm)
Cargo Box Dimensions	29.5 x 45.2 x 10.6 in. (75.1 x 114.7 x 27 cm)
Cargo Box Capacity	600 lb (272.2 kg)
Towing Capacity	2,000 lb (907.2 kg)
Payload Capacity	1,030 lb (467.2 kg)
Storage Capacity	Total: 7.3 gal (27.6 L)
Fuel Capacity	10 gal (38 L)
Person Capacity	2

FEATURES	
Gauge	7.6 in. wide digital display with keypad
Instrumentation	DC outlet (10-A)
Anti-theft System	RF Digitally Encoded Security System (D.E.S.S.™) with Start/Stop button
Magneto	650 W
Lighting	Front lighting output 110 W LED signature lights LED tail lights
Winch	4,500 lb (2,041 kg) winch with roller fairlead
Steering Wheel	Adjustable tilt steering
Protection	Premium half doors, Full skid plate, Mudguards, XT front bumper, Full roof
Hitch Type	2 in. hitch receiver

WARRANTY & EXTENDED SERVICE	
Factory Warranty	2 years / 15,000 km, whichever comes first
Service Intervals	200 hours / 12 months / 3000 km

2023 CAN-AM COMMANDER MAX XT-P 1000R



Desert Tan & Carbon Black / 1000R

ENGINE	1000R
Type	100 hp, Rotax® 976 cc, V-twin, liquid-cooled
Fuel Delivery System	Intelligent Throttle Control (ITC™) with Electronic Fuel Injection (EFI)
Transmission	Quick Response System (QRS) CVT with high-airflow ventilation and Electronic Drive Belt Protection Extra-L/H/N/R/P
Drive Train	Selectable Turf Mode/2WD/4WD TRAIL/4WD TRAIL ACTIV with exclusive Smart-Lok technology.
Driving Assistance	Electronic Hill Descent Control SPORT/ECO™ modes
Power Steering	Dynamic Power Steering (DPS™)

SUSPENSIONS

Front Suspension	Arched double A-arm with sway bar/14 in. (35.6 cm) travel
Front Shocks	FOX 2.5 PODIUM Piggyback with QS3 compression adjustment
Rear Suspension	Arched TTA with sway bar/14 in. (35.6 cm) travel
Rear Shocks	FOX 2.5 PODIUM Piggyback with QS3 compression adjustment

TYRES & WHEELS

Front Tyres	XPS Hammer Force 30 x 10 x 14 in.
Rear Tyres	XPS Hammer Force 30 x 10 x 14 in.
Wheels	15 in. cast-aluminum beadlock

BRAKES

Front	Dual 220mm disc brakes with hydraulic twin-piston calipers
Rear	Dual 220mm disc brakes with hydraulic twin-piston calipers

PACKAGE HIGHLIGHTS

- Smart-Lok front differential
- FOX® 2.5 PODIUM QS3® piggyback shocks
- Special edition seats
- 7.6 in. digital display with keypad
- LED headlight & Can-Am LED signature lights
- 64 in. wide with Arched A-arm
- 30 in. XPS Hammer Force tyres
- 15 in. cast-aluminum beadlock wheels
- XT front bumper
- 4,500 lb (2,014 kg) winch
- Full roof & panoramic mirror
- Full Skid plate
- Seating for 4 people

DIMENSIONS & CAPACITIES



Estimated Dry Weight	2,000 lb (907.2 kg)
Chassis/Cage	Profiled cage, ROPS approved
L x W x H	160.4 x 64 x 76.7 in. (407.4 x 162.6 x 194.8 cm)
Wheelbase	120.6 in. (306.3 cm)
Ground Clearance	13.5 in. (34.3 cm)
Cargo Box Dimensions	29.5 x 45.2 x 10.6 in. (75.1 x 114.7 x 27 cm)
Cargo Box Capacity	600 lb (272.2 kg)
Towing Capacity	2,000 lb (907.2 kg)
Payload Capacity	1,280 lb (580.6 kg)
Storage Capacity	Total: 8.5 gal (32.1 L)
Fuel Capacity	10 gal (38 L)
Person Capacity	4

FEATURES

Gauge	7.6 in. wide digital display with keypad
Instrumentation	DC outlet (10-A)
Anti-theft System	RF Digitally Encoded Security System (D.E.S.S.™) with Start/Stop button
Magneto	650 W
Lighting	LED headlight LED signature LED tail lights
Winch	4,500 lb (2,041 kg) winch with roller fairlead
Steering Wheel	Adjustable tilt steering
Protection	Premium half doors, Full skid plate, Mudguards, XT front bumper, Full roof
Hitch Type	2 in. hitch receiver Special Edition seats

WARRANTY & EXTENDED SERVICE

Factory Warranty	2 years / 15,000 km, whichever comes first
Service Intervals	200 hours / 12 months / 3000 km

COMMANDER		DPS	XT	MAX XT-P
				
COLOUR OPTIONS		Tundra Green	Oxford Blue	Desert Tan & Carbon Black
ENGINES	Type	700	1000R	1000R
	Fuel Delivery System	52 hp/41 lb-ft, Rotax® ACE (Advanced Combustion Efficiency) 650 cc single cylinder, liquid-cooled		
	Transmission	Intelligent Throttle Control (ITC™) with Electronic Fuel Injection (EFI)		
	Drive Train	pDrive primary CVT with engine braking and Electronic Drive Belt Protection L/H/N/R/P	Quick Response System (QRS) CVT with high-airflow ventilation and Electronic Drive Belt Protection Extra-L/H/N/R/P	
	Driving Assistance	Selectable Turf Mode/2WD/4WD with Visco-Lok [†] QE auto-locking front differential		
	Power Steering	Electronic Hill Descent Control SPORT/ECO™ modes		
		Dynamic Power Steering (DPS™)		
SUSPENSIONS	Front Suspension	Double A-arm with sway bar/ 12.5 in. (31.8 cm) travel	Arched double A-arm with sway bar/ 15 in. (38.1 cm) travel	Arched double A-arm with sway bar/ 14 in. (35.6 cm) travel
	Front Shocks	Twin-tube gas-charged shocks		FOX [†] 2.5 PODIUM Piggyback with QS3 [†] compression adjustment
	Rear Suspension	TTA with sway bar/13 in. (33 cm) travel	Arched TTA with sway bar/15 in. (38.1 cm) travel	Arched TTA with sway bar/14 in. (35.6 cm) travel
	Rear Shocks	Twin-tube gas-charged shocks		FOX [†] 2.5 PODIUM Piggyback with QS3 [†] compression adjustment
TYRES/ WHEELS	Front/Rear Tyres Wheels	XPS Trail Force 27 x 9/11 x 14 in. 14 in. steel	XPS Trail King 28 x 9/11 x 14 in. 14 in. cast-aluminum	XPS Hammer Force 30 x 10/10 x 15 in. 15 in. cast-aluminum beadlock
BRAKES	Front & Rear	Dual 220 mm disc brakes with hydraulic twin-piston calipers		
DIMENSIONS/CAPACITIES	Estimated Dry Weight	1,530 lb (694 kg)	1,675 lb (759.8 kg)	2,000 lb (907.2 kg)
	Chassis/Cage	Profiled cage, ROPS approved		
	L x W x H	128.5 x 62 x 70.5 in. (326.4 x 157.5 x 180.2 cm)	130 x 64 x 74 in. (330.2 x 162.6 x 188 cm)	160.4 x 64 x 76.7 in. (407.4 x 162.6 x 194.8 cm)
	Wheelbase	90.6 in. (230.1 cm)		120.6 in. (306.3 cm)
	Ground Clearance	12.5 in. (31.8 cm)	13 in. (33 cm)	13.5 in. (34.3 cm)
	Cargo Box Dimension	29.5 x 45.2 x 10.6 in. (75.1 x 114.7 x 27 cm)		
	Cargo Box Capacity	600 lb (272.2 kg)		
	Towing Capacity	2,000 lb (907.2 kg)		
	Payload Capacity	1,030 lb (467.2 kg)		1,280 lb (580.6 kg)
	Storage Capacity	Total: 7.3 gal (27.6 L)		Total: 8.5 gal (32.1 L)
	Fuel Capacity	10 gal (38 L)		
	Person Capacity	2		4
	FEATURES	Gauge	4.5 in. wide digital display	7.6 in. wide digital display with keypad
Instrumentation		DC outlet (10-A)		
Anti-theft System		RF Digitally Encoded Security System (D.E.S.S.™) with Start/Stop button		
Magneto		650 W		
Lighting		Front lighting output 110 W LED tail lights	Front lighting output 110 W LED signature lights LED tail lights	LED headlight LED signature lights LED tail lights
Winch		N/A	4,500 lb (2,041 kg) winch with roller fairlead	
Steering Wheel		Adjustable tilt steering		
Protection		Premium half doors Full skid plate Mudguards	Premium half doors Full skid plate Mudguards XT front bumper Full roof	Premium half doors Full skid plate Mudguards XT front bumper Full roof Special Edition seats
Hitch Type		2 in. hitch receiver		

[†]Visco-Lok is a trademark of GKN Viscodrive GmbH.

*Smart-Lok was developed in conjunction with TEAM Industries, a market leader in the drive train industry.



ACCESSORIES COMMANDER

Image for visual purposes only. Package shown not available in region.

ROOFS

Sport Roof

Commander, Maverick Trail, Maverick Sport

715007271

Commander MAX, Maverick Sport MAX

715007272



- Excellent protection from the elements.
- Allows installation of lights on top of the roof.
- Compatible with all windshields.

ProVent Roof Module Kit

Commander, Maverick Trail, Maverick Sport

715005279



- Provides fresh air in the cab area.
- Optimal performance with full cab enclosure.
- 4 vents provide infinite adjustment of air flow for driver and passenger.
- Filter and pre-filter to limit dust intrusion.
- Easy cleaning of filter and pre-filter.
- Patent pending water management system to keep water out of cabin while maintaining air flow.
- Outer plug closes air intake completely for winter or heavy weather.
- Requires ProVent Roof Module Adapter Kit for Sport Roof.
- Not compatible with roof mounted LED bars, roof racks, roof liners, Bimini Roof, DragonFire Roof and Lonestar Racing Roof.

ProVent Roof Module Adapter Kit for Sport Roof

(Not illustrated)

Commander, Maverick Trail, Maverick Sport

715005213

- Adapter for fitting ProVent Roof Module Kit onto Commander, Maverick Sport or Maverick Trail Sport Roof.
- Includes roof adapter and hardware.
- Requires ProVent Roof Module Kit (715005279).

Bimini[†] Roof with Sun Visor

Commander, Maverick Trail, Maverick Sport[†]

715003661

Commander MAX, Maverick Sport MAX

715004792



- Heavy-duty canvas made of UV-resistant solution-dyed polyester.
- Soft top comes with a hard visor that allows for storage of rolled-up soft top and mounting auxiliary lights.

†Not compatible with Glass Windshield with wiper.

Lonestar Racing[†] Aluminum Roof

Commander, Maverick Trail, Maverick Sport[†]

■ **715005137** · Black

Commander MAX, Maverick Sport MAX

■ **715003831** · Can-Am Red

■ **715004892** · Can-Am Red



- Race-true low profile look with integrated front visor for eye-popping performance and protection.
- 0.083" (2.1 mm) thick aluminum roof for durable and lightweight protection from the elements.
- Compatible with Lonestar Racing Mounts for 39" (99 cm) Double Stacked LED Light Bar (715004877).
- Not compatible with Full Windshields, Rigid Rear Window, Can-Am Intrusion Bars and Overhead Switch Panel.

SOFT CAB ENCLOSURE

Soft Cab Enclosure	Maverick Trail	715003618
	<p>Includes:</p> <ul style="list-style-type: none"> - Sport Roof - Full Windshield – Hardcoated - Upper Soft Door Panels - Soft Rear Panel - Door Seal Kit - Requires Half Doors on 800 Base and 800 DPS models - Not compatible with Sport Half Doors 	

Soft Cab Enclosure	Commander, Maverick Trail, Maverick Sport (except X mr models)	715004724
	<ul style="list-style-type: none"> • Can be installed on the Maverick Trail equipped with the Sport Half Doors or on Maverick Sport models. <p>Includes:</p> <ul style="list-style-type: none"> - Sport Roof - Full Windshield – Hardcoated - Upper Soft Door Panels - Soft Rear Panel 	

Soft Cab Enclosure	Commander MAX, Maverick Sport MAX (except X mr models)	715004725
	<p>Includes:</p> <ul style="list-style-type: none"> - Sport Roof - Full Windshield – Hardcoated - Upper Soft Door Panels - Soft Rear Panel 	

WINDSHIELDS & WIND PROTECTION

Windshields

Glass Windshield	Commander, Commander MAX, Maverick Trail, Maverick Sport, Maverick Sport MAX	715003653
	<ul style="list-style-type: none"> • Curved and laminated glass full windshield in metal frame. • Provides excellent optical clarity. • Seals firmly against the cage and protects rider and passenger from the elements. • Must be used with a rear wind protection. • Not EC compliant. 	

Glass Windshield with Wiper	Commander, Commander MAX, Maverick Trail, Maverick Sport, Maverick Sport MAX	715003652
	<ul style="list-style-type: none"> • Curved and laminated glass full windshield in metal frame. • Provides excellent optical clarity. • Seals firmly against the cage and protects rider and passenger from the elements. • Single-speed wiper with washer fluid dispenser. • Requires the Overhead Switch Panel (715003669) for installation. • Must be used with rear wind protection. • Not EC compliant. 	

Windshield Wiper and Washer Kit	Commander, Commander MAX, Maverick Trail, Maverick Sport, Maverick Sport MAX	715003654
	<ul style="list-style-type: none"> • An ideal way to keep your windshield clear in rain, or while riding through mud and water. • Includes single-speed wiper, washer fluid dispenser and windshield frame mount. • Must be used with the Glass Windshield (715003653). • Requires Overhead Switch Panel (715003669) for installation. • Not EC compliant. • Not compatible with ABS equipped vehicles. 	

Half Windshield

Commander, Commander MAX,
Maverick Trail, Maverick Sport, Maverick Sport MAX

715003657 · Clear
 715005280 · Tinted



- Formed polycarbonate construction for enhanced rigidity.
- Formulated to be non-yellowing, non-crazing, non-cracking with excellent UV resistance and optical clarity.
- Protects driver and passenger from the elements.
- Features reverse angle lip to deflect air flow.
- Quick and easy tool-less installation or removal.

Full Windshield

Commander, Commander MAX,
Maverick Trail, Maverick Sport, Maverick Sport MAX

715003655



- High-impact-resistant durable polycarbonate full windshield.
- Formed polycarbonate construction for enhanced rigidity.
- Formulated to be non-yellowing, non-crazing, non-cracking with excellent UV resistance and optical clarity.
- Seals firmly against the cage and protects rider and passenger from the elements.
- Must be used with rear wind protection.
- Quick and easy tool-less installation or removal.

Full Windshield – Hardcoated

Commander, Commander MAX,
Maverick Trail, Maverick Sport, Maverick Sport MAX

715003656



- High-impact-resistant Quantum¹ hardcoated polycarbonate full windshield.
- Formed polycarbonate construction for enhanced rigidity.
- Provides excellent optical clarity and better abrasion resistance.
- Seals firmly against the cage and protects rider and passenger from the elements.
- Must be used with rear wind protection.
- Quick and easy tool-less installation or removal.

ProVent Windshield

Commander, Commander MAX,
Maverick Trail, Maverick Sport, Maverick Sport MAX

715005210



- High-impact-resistant Quantum¹ hardcoated polycarbonate full windshield.
- Controllable vents to manage air flow.
- Channels air into the cabin, defogs windshield, fully closes to eliminate air flow.
- One upper vent and one lower vent with pre-filters.
- Must be used with rear wind protection.
- Provides excellent optical clarity and better abrasion resistance.
- Protects driver and passenger from the elements.
- Quick and easy tool-less installation or removal.
- Not compatible with wiper kits and Wet Sounds Stealth 6 Ultra HD Can-Am Edition Sound Bar.
- Not compatible with the Defrost, Heat & Ventilation System.

PowerFlip Windshield

Commander, Commander MAX,
Maverick Trail, Maverick Sport, Maverick Sport MAX

715003658



- The PowerFlip Windshield is equipped with electric cylinders that allow the rider to adjust the windshield opening at the touch of a button.
- Windshield is made of hardcoated polycarbonate with a rubber seal contour and a tinted top section.
- Allows you to quickly adapt to changing conditions by adjusting the windshield as you go.
- Can be fully opened for optimal visibility and ventilation, fully closed for maximum protection from the elements, and in between, you have an infinite number of openings.
- Must be used with rear wind protection.

Wind Protection

Side Wind Deflectors

Commander, Commander MAX,
Maverick Trail, Maverick Sport, Maverick Sport MAX

715008632



- Clear polycarbonate air deflectors mount on each side of the cage.
- Can be adjusted at three different positions for cabin air flow control when full windshield is installed:
 - 1) Outside deflection to reduce cabin air flow and turbulence.
 - 2) Inside deflection to increase air flow in the cabin.
 - 3) Windshield ventilation to reduce fog.
- Compatible with all windshields.
- Not compatible with full doors.
- Sold in pairs.

Rear Polycarbonate Window

Commander, Commander MAX, Maverick Trail,
Maverick Sport, Maverick Sport MAX (except X mr models)

715006113



- High-impact-resistant polycarbonate window.
- Blocks windshield backdraft or dust and rain from entering for added cabin comfort.
- Sport Roof is required for installation.
- Not compatible with Bimini Roof with Sun Visor, DragonFire Aluminum Roof and Lonestar Racing Aluminum Roof.

Rear Wind Screen

Commander, Commander MAX, Maverick Trail,
Maverick Sport, Maverick Sport MAX (except X mr models)

715003664



- Full rear mesh screen reduces windshield backdraft for added cabin comfort.
- Installs quickly and easily on roll cage.
- Large Can-Am branding.

Soft Rear Panel

Commander, Commander MAX, Maverick Trail,
Maverick Sport, Maverick Sport MAX (except X mr models)

715005887



- Plastic reinforced and weather-resistant rear panel offers good protection from the elements.
- Made of heavy-duty UV-resistant solution-dyed polyester canvas for excellent resistance to tear and abrasion.
- Clear window made of laminated polished vinyl material.
- Resists cold cracking.
- Installs quickly and easily on roll cage.

DOORS

Trail Half Doors

Maverick Trail

715004418



- Half doors made of molded polypropylene to match vehicle's styling.
- Steel frame for high level of rigidity.
- A must-have for additional cabin comfort.
- Keep the vehicle narrow in tight trail riding conditions.
- Door Trim is required to complete your door kit (sold separately).
- Standard on 1000 Base and 1000 DPS models.
- Sold in pairs.

Door Trim

Maverick Trail

- Can-Am Red
- Timeless Black
- Octane Blue

	Left	Right
Can-Am Red	705012419	705012420
Timeless Black	705015607	705015613
Octane Blue	705016447	705016449



- Matching coloured panel for Trail Half Doors.
- Required to complete the Trail Half Doors (sold separately).

Sport Half Doors

Commander, Commander MAX,
Maverick Sport, Maverick Sport MAX

715006217



- Half doors made of molded polypropylene to match vehicle's styling.
- A must-have for additional cabin comfort.
- Features rounded shape to increase cabin space.
- Standard on all Commander & Maverick Sport models.
- Can be installed on Maverick Trail models for additional cabin space.
- Door Trim is required to complete your door kit (sold separately).
- Sold in pairs.

Door Trim

Commander, Commander MAX,
Maverick Trail, Maverick Sport,
Maverick Sport MAX

- Can-Am Red
- Timeless Black
- Octane Blue

	Left	Right
Can-Am Red	705015464	705015465
Timeless Black	705015608	705015615
Octane Blue	705016448	705016450



- Matching coloured panel for the Sport Half Doors.
- Required to complete the Sport Half Doors (sold separately).
- Sold in pairs.

Upper Soft Door Panels

Commander, Maverick Trail†, Maverick Sport,
Commander MAX, Maverick Sport MAX‡

715004718
715004727



- Upper canvas portion of the doors with sturdy steel frame.
- Seals firmly against the cage and protects rider and passenger from the elements.
- Converts half door into full door for a complete cab enclosure.
- Zippered window made of laminated polished vinyl material for added ventilation.
- Easy to remove on hot and sunny days.
- Sport Roof required for installation.

†Not compatible with Trail Half Doors or with the standard half doors on Maverick Trail models.
‡Includes Upper Soft Door Panels for front and rear doors.

Upper Soft Door Panels

(Not illustrated)

Maverick Trail

715003620

- Can only be installed with Trail Half Doors or with the standard half doors on Maverick Trail models.
- Not compatible with Sport Half Doors or with the standard half doors on Maverick Sport models.
- Sport Roof required for installation.

Door Seal Kit

(Not illustrated)

Maverick Trail

715004773

- Improves door sealing from the elements and provides additional cabin comfort.
- Included in the Soft Cab Enclosure kit (715003618).
- Not compatible with Sport Half Doors.
- Compatible with the Trail Half Doors or with the stock doors on the Maverick Trail.

Door Knee Pads with Storage	Maverick Trail	715003635
	<ul style="list-style-type: none"> • Padded door cushion with integrated pocket for storage. • Protect driver and passenger legs from direct contact with the doors while riding. • Increase cabin comfort. • Require Trail Half Door on 800 Base and 800 DPS models (715004418). • Offer storage space for small items. • Sold in pairs. • Not compatible with Sport Half Doors. 	

Door Storage with Padding	Commander, Commander MAX, Maverick Trail, Maverick Sport, Maverick Sport MAX	715004914
	<ul style="list-style-type: none"> • Weather-resistant door storage bags with integrated padding. • Holds your gear safely and securely and also protects driver and passenger legs from direct contact with the doors while riding. • Each bag is designed as a 0.5 gal (2 L) capacity pocket also equipped with inner netting compartments. • Semi-rigid construction renders them flexible enough to fit odd-shaped loads. • Easy to install. • Sold in pairs. • Bags attach on stock doors of the Maverick Sport or on the Maverick Trail equipped with the Sport Half Doors (715006217). • Not compatible with stock doors on the Maverick Trail or the Trail Half Doors. 	

MIRRORS

Side Mirrors	Commander, Commander MAX, Maverick Trail, Maverick Sport, Maverick Sport MAX	715003639
	<ul style="list-style-type: none"> • Rugged black nylon % construction with coated cast-aluminum mount. • Dual adjustment (horizontal and vertical) will suit any rider. • Convex optics deliver optimal field of view (FOV). • Spring-loaded pivots let mirrors fold back completely. • Sold in pairs. 	

Panoramic Center Mirror	Commander, Commander MAX, Maverick Trail, Maverick Sport, Maverick Sport MAX	715003638
	<ul style="list-style-type: none"> • Wide-angle convex mirror. • Offers enhanced visibility. • Can be used with or without roof or windshield and with cab enclosure. 	

Sport Panoramic Center Mirror	Commander, Commander MAX, Maverick Trail, Maverick Sport, Maverick Sport MAX	715004924
	<ul style="list-style-type: none"> • Convex mirror for wide rearward visibility. • Ball-joint design with tightening knob for steady multi-angle adjustment. • Can be used with or without roof or windshield. • Not for road use. 	

Rear View Mirror and Camera Monitor	Commander, Commander MAX, Maverick Trail, Maverick Sport, Maverick Sport MAX	715004905
	<ul style="list-style-type: none"> • Fully waterproof rear view camera and monitor kit. • Multiple camera feeds can be seen with the rear view camera, to see what you need. • Unit replaces stock rear view mirror (screen is integrated in the unit's replacement rear view mirror). • Camera uses infrared light for night vision capabilities. 	

COMMANDER

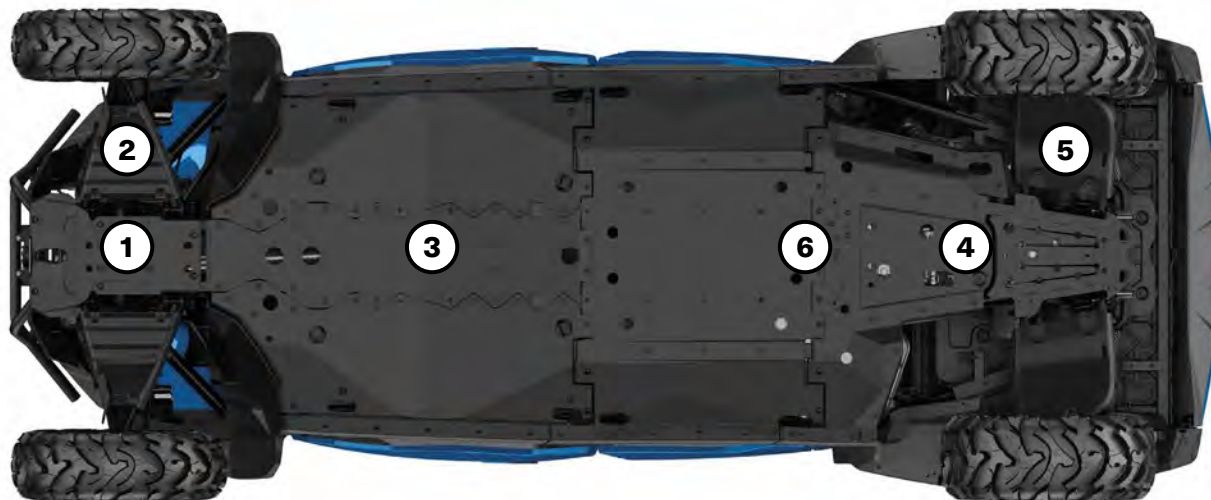

Our plastic plates glide smoothly and silently over obstacles, offering great protection in rough terrain.

- Made of abrasion-resistant thermoformed High Molecular Weight Polyethylene (HMWPE).
- Lighter than aluminum.

- High impact strength.
- Ultra-sturdy 3/8" (10 mm) thickness.

COMMANDER, COMMANDER MAX

Offer your Commander the full protection kit or get parts individually

DPS & XT 700

XT 1000, XT-P & X mr

HMWPE Skid Plate Protection Kit

Includes:

- HMWPE Front Skid Plate.
- HMWPE Front A-Arm Protectors.
- HMWPE Rear Skid Plate.
- HMWPE Rear A-Arm Protectors.
- HMWPE Underbelly Plates.
- HMWPE Central Skid Plate.

715006349
(except MAX)

715006350
(except MAX)

715006351
(MAX Only)

715007303
(MAX Only)

Individual HMWPE Skid Plates

① HMWPE Front Skid Plate

715008279

715008279

② HMWPE Front A-Arm Protectors

715008276

715008277

③ HMWPE Underbelly Plates

Keeps the rollover clearance.

715006273

715006273

④ HMWPE Rear Skid Plate

715007302

715007302

⑤ HMWPE Rear A-Arm Protectors

715004271

715006341

⑥ HMWPE Central Skid Plate

Provides center protection for MAX models.

715004272
(MAX Only)

715004272
(MAX Only)

MAVERICK TRAIL & MAVERICK SPORT

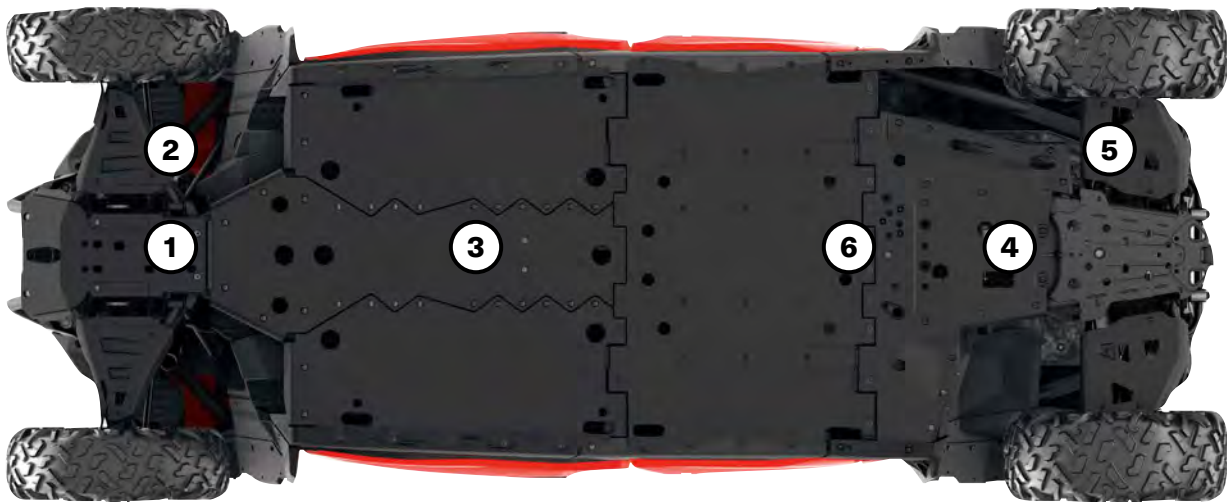

Our plastic plates glide smoothly and silently over obstacles, offering great protection in rough terrain.

- Made of abrasion-resistant thermoformed High Molecular Weight Polyethylene (HMWPE).
- Lighter than aluminum.

- Superior stress crack resistance.
- High impact strength.
- Ultra-sturdy $\frac{3}{8}$ " (10 mm) thickness.

MAVERICK SPORT & MAVERICK SPORT MAX MAVERICK TRAIL

	2019 Base & DPS	2019 X mr	2020 & Up Base & DPS	2020 & Up X mr	Any Year X rc	
Offer your Maverick the full protection kit or get parts individually						
HMWPE Skid Plate Protection Kit						
Includes:						
- HMWPE Front Skid Plate.	715006348 (except MAX)		715006349 (except MAX)			715006346 (2019 & prior)
- HMWPE Front A-Arm Protectors.		715006353		715006350	—	
- HMWPE Rear Skid Plate.						
- HMWPE Rear A-Arm Protectors.						
- HMWPE Underbelly Plates.	715006352 (MAX Only)		715006351 (MAX Only)			715006347 (2020 & up)
- HMWPE Central Skid Plate.						
Individual HMWPE Skid Plates						
① HMWPE Front Skid Plate	715008279	715008279	715008279	715008279	(Standard on X rc models)	715008279
② HMWPE Front A-Arm Protectors	715008276	715008277	715008276	715008277	(Standard on X rc models)	715008278
③ HMWPE Underbelly Plates Keeps the rollover clearance.	715006339	715006339	715006273	715006273	715006339 (2019) 715006273 (2020 & up)	715006339 (2019 & prior) 715006273 (2020 & up)
④ HMWPE Rear Skid Plate	715007302	715007302	715007302	715007302	715007302	715007302
⑤ HMWPE Rear A-Arm Protectors	715004271	715006341	715004271	715006341	(Standard on X rc models)	715003699
⑥ HMWPE Central Skid Plate Provides center protection for MAX models.	715004272 (MAX Only)	—	715004272 (MAX Only)	—	—	—

BUMPERS & GUARDS

Commander Bumpers

X mr Front Bumper

Commander, Commander MAX

715007248 · Black



- Heavy-duty 1.5" (3.8 cm) diameter steel-tube construction.
- Inside and outside anti-corrosion coating with durable finish.
- Provides additional front body protection.
- Integrated winch support plate for winch relocation at a higher position for easier access in muddy conditions or for auxiliary lights.
- Allows the installation of front corner protectors.
- Winch not included.

Front Bumper

Commander, Commander MAX

715007631



- Made of 1.5" (3.8 cm) diameter steel tubing with durable powder-coat finish.
- Includes integrated mount points for seamless light installation.
- Compatible with synthetic and steel rope winches and hawse fairlead.
- Not EC compliant.

Front Corner Protectors

Commander, Commander MAX

715006807



- Heavy-duty 1.5" (3.8 cm) diameter steel tubing.
- Inside and outside anti-corrosion coating with durable powder-coat finish.
- Provide additional protection for vehicle's front corners.
- Requires stock XT, XT-P or X mr bumper.
- Sold in pairs.
- Not EC compliant.

Rear Bumpers

Commander, Commander MAX

715006808



- Rear bumper made of heavy-duty 1.5" (3.8 cm) diameter steel tubing.
- Protect vehicle bodywork and exhaust system.
- Inside and outside anti-corrosion coating with durable powder-coat finish.
- Compatible with Mud Flaps.
- Not EC compliant.

Maverick Trail & Maverick Sport Bumpers

Front Trail Bumper

Maverick Trail, Maverick Sport, Maverick Sport MAX

■ 715003680 · Black
■ 715003681 · Sunburst Yellow



- Front bumper made of heavy-duty 1.5" (3.8 cm) diameter steel tubing.
- Completes the stock bumper for more front coverage and essential vehicle protection for trail riders.
- Inside and outside anti-corrosion coating with durable powder coat finish.
- Includes integrated mount points for seamless light installation.

Rear Trail Bumper

Maverick Trail, Maverick Sport, Maverick Sport MAX

■ 715007109 · Black



- Rear bumper made of heavy-duty 1.5" (3.8 cm) diameter steel tubing.
- Protects vehicle bodywork and exhaust system.
- Inside and outside anti-corrosion coating with durable powder coat finish.







Front Corner Protectors

Maverick Trail, Maverick Sport, Maverick Sport MAX

■ 715004912 · Black



- Heavy-duty 1.5" (3.8 cm) diameter steel tubing.
- Inside and outside anti-corrosion coating with durable powder coat finish.
- Provide additional protection for vehicle's front corners.
- Require Front Trail Bumper (715003680 / 715003681) for installation.
- Sold in pairs.

Rancher Front Bumper	Maverick Trail, Maverick Sport, Maverick Sport MAX	715004303
	<ul style="list-style-type: none"> • Heavy-duty protection made of 1.5" (3.8 cm) diameter steel tubing, perfect for farm, ranch and forestry applications. • Inside and outside anti-corrosion coating with durable powder coat finish. • Offers full front coverage and superior headlight protection. • Removable radiator protector to allow light installation. • Rugged look. • Not EC compliant. 	
Rancher Rear Bumper	Maverick Trail, Maverick Sport, Maverick Sport MAX	715004304
	<ul style="list-style-type: none"> • Heavy-duty protection made of 1.5" (3.8 cm) diameter steel tubing, perfect for farm, ranch and forestry applications. • Inside and outside anti-corrosion coating with durable powder coat finish. • Offers full rear coverage with integrated tail light protectors. • Not EC compliant. 	
Lonestar Racing Front Bumper	Maverick Trail, Maverick Sport, Maverick Sport MAX	<ul style="list-style-type: none"> ■ 715005131 · Black ■ 715004871 · Can-Am Red
	<ul style="list-style-type: none"> • Race-engineered to Lonestar Racing's trademark standards for toughness, these stylishly crafted accessories will also enhance your vehicle with visual impact. • Made of 1.5" (3.8 cm) diameter steel tubing with durable powder coat finish. • Billet End Cap with Lonestar Racing logo. • Compatible with Warn synthetic winch only. 	
Lonestar Racing Rear Bumper	Maverick Trail, Maverick Sport, Maverick Sport MAX	■ 715004873 · Can-Am Red
	<ul style="list-style-type: none"> • Race-engineered to Lonestar Racing's trademark standards for toughness, these stylishly crafted accessories will also enhance your vehicle with visual impact. • Made of 1.5" (3.8 cm) diameter steel tubing with durable powder coat finish. • Billet End Cap with Lonestar Racing logo. • Provides additional vehicle-rear bodywork and exhaust system protection in extreme driving conditions. 	
Lonestar Racing Number Plate	Maverick Trail, Maverick Sport, Maverick Sport MAX	715004878
	<ul style="list-style-type: none"> • Race-bred in the Lonestar tradition of competition-level riding, this number plate will brand your vehicle a winner. • Includes a pair of sturdy aluminum number plates. • Create your personalized number decal through SCS Unlimited. • Not compatible with the All-Terrain Trunk Cover. 	
DragonFire Front Bumper	Maverick Trail, Maverick Sport, Maverick Sport MAX	<ul style="list-style-type: none"> ■ 715005128 · Black ■ 715004456 · Can-Am Red
	<ul style="list-style-type: none"> • 1.5" (3.8 cm) diameter steel tubing with durable powder coat finish and reinforced with a 0.09" (2.3 mm) thick steel plate. • Delivers additional protection for your vehicle. • Sleek lines designed to match your vehicle's body and greatly enhance the overall look. • Combines perfectly with the DragonFire Front Exo-Frame. • Billet End Caps with DragonFire Logo. • Not compatible with the Front Receiver Hitch. • Includes brackets for auxiliary light mounting. 	
DragonFire Rear Bumper	Maverick Trail, Maverick Sport, Maverick Sport MAX	■ 715004457 · Can-Am Red
	<ul style="list-style-type: none"> • 1.5" (3.8 cm) diameter steel tubing with durable powder coat finish and reinforced with a 0.09" (2.3 mm) thick steel plate. • Delivers additional protection for your vehicle. • Sleek lines designed to match your vehicle's body and greatly enhance the overall look. • Billet End Caps with DragonFire Logo. 	

S3[†] Front Bumper

Maverick Trail, Maverick Sport, Maverick Sport MAX

■ **715005121** · Black
■ **715004880**
· Sunburst Yellow



- Made of extra durable 1.5" (3.8 cm) diameter steel tubing.
- Inside and outside anti-corrosion coating with durable powder coat finish.
- Replaces stock bumper and adds superior protection for mud-riding enthusiasts.
- Integrated mount points for lights.
- Hook support anchor allows you to keep the winch hook within easy reach when riding in deep mud.
- "S3 for Can-Am" branded.
- Winch not included.

S3[†] Rear Bumper

Maverick Trail, Maverick Sport, Maverick Sport MAX

■ **715005122** · Black
■ **715004881**
· Sunburst Yellow



- Made of extra durable 1.5" (3.8 cm) diameter steel.
- Inside and outside anti-corrosion coating with durable powder coat finish.
- Added heavy-duty protection in extreme driving conditions—protects vehicle bodywork and exhaust system.
- Permits installation of a winch at a higher location to improve accessibility in mud-riding conditions.
- Engineered to sustain heavy winch loads without damaging the vehicle's frame.
- Compatible with Can-Am HD and WARN VRX winches—Rear Winch Harness (715006008) is required to install a winch on the bumper.
- Includes a License Plate Support Mount.
- Not EC compliant.
- "S3 for Can-Am" branded.
- Winch not included.

Rear Winch Harness

(Not illustrated)

Maverick Trail, Maverick Sport, Maverick Sport MAX

715006008

Rock Sliders

Rock Sliders

Commander, Maverick Trail, Maverick Sport (except X re)
Commander MAX, Maverick Sport MAX

■ **715003689** · Black
■ **715004754** · Black



- Made of heavy-duty 1.5" (3.8 cm) diameter steel tubing.
- Inside and outside anti-corrosion coating with durable powder coat finish.
- Protect vehicle's rocker panels and undercarriage against large obstacles.
- Sold in pairs.

Lonestar Racing Rock Sliders

Commander, Maverick Trail, Maverick Sport (except X re)
Commander MAX, Maverick Sport MAX

■ **715005135** · Black
■ **715004875** · Can-Am Red
■ **715004893** · Can-Am Red



- Race-engineered to Lonestar Racing's trademark standards for toughness, these stylishly crafted accessories will also enhance your vehicle with visual impact.
- Made of 1.5" (3.8 cm) diameter steel tubing with durable powder coat finish filled with 1/8" (3 mm) aluminum plate.
- Billet end-cap with Lonestar Racing logo.
- Protect vehicle sides from large obstacles.
- Sold in pairs.

Intrusion Bars

Front Intrusion Bar

Commander, Commander MAX,
Maverick Trail, Maverick Sport, Maverick Sport MAX

715003872



- Steel intrusion bar matches perfectly with vehicle's styling.
- Inside and outside anti-corrosion coating with durable powder coat finish.
- Provides additional protection by preventing large objects from entering the driver/passenger area.
- Tube design reduces obstructed lines of sight and blind spots for better visibility.
- Not compatible with windshields and Soft Door Panels.

DragonFire Spare Tyre Holder

Maverick Trail, Maverick Sport, Maverick Sport MAX
(except X mr models)

■ **715005125** · Black



- 1.5" (3.8 cm) diameter steel tubing with durable powder coat finish.
- Sleek lines designed to match your vehicle's body and greatly enhance the overall look.
- Easy-to-install roll cage mounted spare-tyre holder.
- Accommodates tyres up to 28" in diameter (wheel not included).
- Uses standard bolt pattern for wheel installation.
- Not compatible with LinQ pivoting rack, All-Terrain Trunk Cover, Gear Rail and accessories mounted in the cargo bed.

Lonestar Racing Front Intrusion Bar

Maverick Trail, Maverick Sport, Maverick Sport MAX
(2020 and prior)

■ **715004872** · Can-Am Red



- Race-engineered to Lonestar Racing's trademark standards for toughness, these stylishly crafted accessories will also enhance your vehicle with visual impact.
- Made of 1.5" (3.8 cm) diameter steel tubing with durable powder coat finish.
- Provides additional protection for driver and passenger.
- Compatible with Lonestar Racing Aluminum Roof.
- Not compatible with windshields, Bimini Roof with Sun Visor and Sport Roof.

Lonestar Racing Rear Intrusion Bar

Maverick Trail, Maverick Sport

■ **715005134** · Black
■ **715004874** · Can-Am Red



- Race-engineered to Lonestar Racing's trademark standards for toughness, these stylishly crafted accessories will also enhance your vehicle with visual impact.
- Made of 1.5" (3.8 cm) diameter steel tubing with durable powder coat finish.
- Provides additional protection for driver and passenger.
- Not compatible with the Sport Roof, rear panels and windows, All-Terrain Trunk Cover.
- Not compatible with X mr models or with the Snorkel Kit.
- Not compatible with S&B particle separator.

Lonestar Racing Spare Tyre Holder

Maverick Trail, Maverick Sport, Maverick Sport MAX
(except X mr)

■ **715005136** · Black
■ **715004876** · Can-Am Red



- Race-conceived for riders who believe a Plan B means thinking like a pro.
- Holds wheel securely no matter how rough the trail.
- Made of 1.5" (3.8 cm) diameter steel tubing with durable powder coat finish.
- Easy, bolt-on installation on roll cage.
- Can accommodate tyres up to 27" (wheel not included).
- Not compatible with All-Terrain Trunk Cover, Fixed Tailgate, LinQ Cargo Rack and LinQ Rack Extension.
- Not compatible with Snorkel Kit.

Fender Flares

Fender Flares

Commander, Commander MAX

715006814



- Fender flares made from injection-molded polypropylene.
- Keep mud and debris out of vehicle.
- Designed for quick and easy installation.
- Front and rear extensions and mounting hardware included.
- Increase vehicle's overall width by 3" (8 cm) when installed on Commander and Commander MAX models.

2" (51 mm) Fender Flares

Maverick Trail

715004958



- Extended fender flares made from injection-molded polypropylene.
- Keep mud and debris out of vehicle.
- Designed for quick and easy installation.
- Include front and rear extensions, mounting hardware and Fender Flare Rear Extensions (715004404).
- Increase vehicle's overall width by 3.5" (8.9 cm).

Fender Flare Rear Extensions

Maverick Trail

715004404



- Help tail light stay clean from debris and mud to remain visible. Can be installed with 2" (51 mm) Fender Flares (715003625).
- Made from injection-molded polypropylene for best fit and finish.
- Sold in pairs.
- Included with the 2" (51 mm) Fender Flares (715004958) and with the Fender Flare Extensions (715004462).

3" (76 mm) Fender Flares

Maverick Trail, Maverick Sport, Maverick Sport MAX

715004959



- Fender flares made from injection-molded polypropylene.
- Keep mud and debris out of vehicle.
- Designed for quick and easy installation.
- Include front and rear extensions and mounting hardware.
- Increase vehicle's overall width by 6" (15.3 cm) when installed on Maverick Trail models.
- Standard on Maverick Sport models.

Fender Flare Rear Extensions

Maverick Trail, Maverick Sport, Maverick Sport MAX

715004462



- Block terrain debris from kicking up onto you as you ride or damaging your vehicle thanks to these extra-large Fender Flare Extensions, which also include Rear Extensions (715004404) for added protection from mud/snow, especially when riding with track kits.
- Made from injection-molded polypropylene for best fit and finish.
- Not compatible with 2" (51 mm) Fender Flares.
- Include front and rear extensions.
- For Maverick Trail, must be used with 3" (76 mm) Fender Flares (715004959).
- Standard on Maverick Sport X mr models.

Others

License Plate Holder

Maverick Trail, Maverick Sport, Maverick Sport MAX

715007006



- Supports your license plate on the Rear Trail Bumper.
- Plate lights can be relocated on bumper to light up license plate.
- Require Rear Trail Bumper (715007109) for installation.
- EC compliant.

Tail Light Protectors

Maverick Trail, Maverick Sport, Maverick Sport MAX

715003692



- Anti-corrosion coating with durable powder coat finish.
- Rugged style, aggressive look.
- Sold in pairs.
- Not EC compliant.

Radiator Protector

Maverick Trail, Maverick Sport, Maverick Sport MAX

715003700

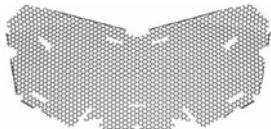

- Perforated steel shield mounted over the radiator face, providing protection from stones and branches.
- Not recommended for winter use.

SEAT ACCESSORIES

4-Point Harness

Commander, Commander MAX,
Maverick Trail, Maverick Sport, Maverick Sport MAX

715008035 · Driver

715008036 · Passenger



- Exclusive controlled decelerator technology (patent pending) absorbs additional energy in case of accident.
- Designed to offer maximum riding comfort.
- Easy one-click latch and release.
- Not EC compliant.
- ROHVA compliant.
- Requires 4-point harness bar, ROHVA compliant when used in conjunction with Can-Am harness bars.

4-Point Harness Bar

Commander MAX, Maverick Sport MAX

715004847



- 1.5" (3.8 cm) diameter, thick-walled steel tubing.
- Designed for use with Can-Am 4-Point Harness.
- Not EC compliant.

Seat Belt Shoulder Pads

Commander, Commander MAX,
Maverick Trail, Maverick Sport, Maverick Sport MAX

715002894



- Provide additional riding comfort by preventing seat belt from rubbing on neck and shoulder.
- Fit with stock 3-point seat belts and 4 point harness.
- Easy Velcro installation.
- Can-Am branded.
- Sold in pairs for driver and passenger.

LINQ: EASY ON, EASY OFF CARGO

COMMANDER'S LINQ ACCESSORIES

Mounting location and requirements

<ul style="list-style-type: none"> • No tools needed: Quickly install and remove accessories by hand. • Equip your Can-Am for specialized tasks in no time. • Sturdy mounting system that holds up to the roughest terrain. 	Vehicle Standard Cargo Box	LinQ Cargo Rack 715006815	Adventure Roof Rack 715004095	Deluxe Headache Rack 715006823	Rear Adventure Rack 715006809	Passenger Seat Base
--	----------------------------	------------------------------	----------------------------------	-----------------------------------	----------------------------------	---------------------

LinQ Accessories with 16" Base

- LinQ anchors mounted 16 inches apart, center-to-center.
- Lower loading capacity than the LinQ with 36" base accessories.
- Can be used on Can-Am ATV and SSV vehicles, Can-Am Spyder and Ryker vehicles, Sea-Doo watercraft and Ski-Doo snowmobiles.

LinQ 4.2 Gal Cooler 295100698 • Gray 219400964 • Black	LinQ Base Installation Kit 715008125	LinQ Base Installation Kit 715008125	LinQ Base Installation Kit 715008125			
LinQ Tool Kit 715006829	No further requirements	No further requirements	No further requirements			
LinQ Tool Box 715008111						
LinQ SR 5.5 Gal (21 L) Bag 860202449	LinQ Base Installation Kit 715008125	LinQ Base Installation Kit 715008125	LinQ Base Installation Kit 715008125	LinQ Base Installation Kit 715008125	LinQ Base Installation Kit 715008125	Passenger Seat LinQ Anchor Kit 715003951
LinQ 4.5 Gal (17 L) Sport Bag 860202447						
LinQ Modular Box 715005494 • (10 L) 715007112 • (20 L) 715006830 • (30 L)	No further requirements	No further requirements	No further requirements			
LinQ Roll-Top Bag 715008110	LinQ Base Installation Kit 715008125	LinQ Base Installation Kit 715008125	LinQ Base Installation Kit 715008125			

LinQ Accessories with 36" Base

- Mount on LinQ racks often used by Can-Am ORV vehicles.
- Higher loading capacity than the LinQ with 16" base accessories.
- Usage is limited to Can-Am ORV vehicles.

LinQ 12 Gal (45 L) Cargo Box 715003879	No compatibility	No further requirements	No compatibility	No compatibility	No compatibility	No compatibility
LinQ 23 Gal (86 L) Trunk Box 715004923		No compatibility				
LinQ Audio Box 715003018		No compatibility				
LinQ Cooler 715004778 • Black 715004698 • Gray		No compatibility				
LinQ OGIO® Bag 715002923 • Black 715004698 • Gray		No further requirements				
LinQ Heavy Duty Basket 715001215						
LinQ Low Profile Basket 715004282						

LinQ Holders

LinQ Gear Grips 715005340	No further requirements	No further requirements	Side wall installation LinQ Adapters 715003058	Side wall installation LinQ Adapters 715003058	Side wall installation LinQ Adapters 715003058	Passenger Seat LinQ Anchor Kit 715003951
LinQ Tool Holder 715007358						

MAVERICK'S LINQ ACCESSORIES

Mounting location and requirements

<ul style="list-style-type: none"> No tools needed: Quickly install and remove accessories by hand. Equip your Can-Am for specialized tasks in no time. Sturdy mounting system that holds up to the roughest terrain. 	Vehicle Standard Cargo Box	LinQ Cargo Rack 715003702	Adventure Roof Rack 715004095	LinQ Pivoting Rack 715008297	All-Terrain Trunk Cover 715003701	Passenger Seat Base
LinQ Accessories with 16" Base						
<p>LinQ anchors mounted 16 inches apart, center-to-center. Lower loading capacity than the LinQ with 36" base accessories. Can be used on Can-Am ATV and SSV vehicles, Can-Am Spyder and Ryker vehicles, Sea-Doo watercraft and Ski-Doo snowmobiles.</p>						
LinQ 4.2 Gal Cooler 295100698 • Gray 219400964 • Black	LinQ Base Installation Kit 715008125	No compatibility	LinQ Base Installation Kit 715008125	LinQ Anchor Adapter Kit 715004960	LinQ Base Installation Kit 715008125	Passenger Seat LinQ Anchor Kit 715003951
LinQ Tool Kit 715006829	No further requirements	No further requirements	No further requirements	No further requirements	No further requirements	No further requirements
LinQ Tool Box 715008111	LinQ Base Installation Kit 715008125	No compatibility	LinQ Base Installation Kit 715008125	LinQ Anchor Adapter Kit 715004960	LinQ Base Installation Kit 715008125	Passenger Seat LinQ Anchor Kit 715003951
LinQ SR 5.5 Gal (21 L) Bag 860202449						
LinQ 4.5 Gal (17 L) Sport Bag 860202447						
LinQ Modular Box 715005494 • (10 L) 715007112 • (20 L) 715006830 • (30 L)	No further requirements	No further requirements	No further requirements	No further requirements	No further requirements	No further requirements
LinQ Roll-Top Bag 715008110	LinQ Base Installation Kit 715008125	No compatibility	LinQ Base Installation Kit 715008125	LinQ Anchor Adapter Kit 715004960	LinQ Base Installation Kit 715008125	Passenger Seat LinQ Anchor Kit 715003951
LinQ Accessories with 36" Base						
<p>Mount on LinQ racks often used by Can-Am ORV vehicles. Higher loading capacity than the LinQ with 16" base accessories. Usage is limited to Can-Am ORV vehicles.</p>						
LinQ 12 Gal (45 L) Cargo Box 715003879	No compatibility	No further requirements	No compatibility	No further requirements	No compatibility	No compatibility
LinQ 23 Gal (86 L) Trunk Box 715004923		No compatibility				
LinQ 32 Gal (121 L) Trunk Box 715001747		No further requirements				
LinQ Audio Box 715003018		No compatibility				
LinQ Cooler 715004778 • Black 715004698 • Gray		No further requirements				
LinQ OGIO Bag 715002923 • Black		No further requirements				
LinQ Heavy Duty Basket 715001215		No further requirements				
LinQ Low Profile Basket 715004282		No further requirements				
LinQ Holders						
LinQ Gear Grips 715005340	No further requirements (when installed on side walls)	No compatibility	Side wall installation LinQ Adapters 715003058	No further requirements	LinQ Base Installation Kit 715008125	No further requirements
LinQ Tool Holder 715007358						

LinQ Accessories with 16" base

LinQ Modular Box	Commander, Commander MAX, Maverick Trail, Maverick Sport, Maverick Sport MAX	715005494 · (10 L)
		715007112 · (20 L)
		715006830 · (30 L)



- Allows stacking of other modular boxes to always have the right gear accessible.
- Always have the right box size to fit everything.
- Can be installed on any LinQ base with a 16" width.
- See table for installation location and requirements.

Thermal Insert for LinQ Modular Box (10 L)	Commander, Commander MAX, Maverick Trail, Maverick Sport, Maverick Sport MAX	219401110
---	---	------------------



- Insulated liner.
- Fits very well in the LinQ Modular Box (10 L).
- Can contain five 473 ml cans or six 355 ml cans.

LinQ Tool Box	Commander, Commander MAX, Maverick Trail, Maverick Sport, Maverick Sport MAX	715008111
----------------------	---	------------------



- High precision injected HDPE construction provides rigidity and durability.
- 5 gal (19 L) maximum capacity.
- Weather-resistant, sealed and lockable cover.
- Easy one-second on/off tool-less system.
- All the benefits of LinQ—simple, fast and secure.
- See table for installation location and requirements.

LinQ Tool Kit	Commander, Commander MAX, Maverick Trail, Maverick Sport, Maverick Sport MAX	715006829
----------------------	---	------------------



- Includes:

<ul style="list-style-type: none"> - Cutter pliers - Long-nose pliers - Locking pliers - Ratchet wrench 3/8" drive - 6" ratchet extension - Integrated CVT belt storage location (belt not included) 	<ul style="list-style-type: none"> - Long-socket 19 mm 3/8" drive - 6pts - Long-socket 17 mm 3/8" drive - 6pts - Socket 15 mm 3/8" drive - Socket 13 mm 3/8" drive - Socket 10 mm 3/8" drive 	<ul style="list-style-type: none"> - Socket 8 mm 3/8" drive - Combined wrench 19 mm - Combined wrench 18 mm - Combined wrench 15 mm - Combined wrench 13 mm - Combined wrench 10 mm - Combined wrench 8 mm - Socket Torx T40 3/8" drive 	<ul style="list-style-type: none"> - Socket Torx T30 3/8" drive - Socket Torx T20 3/8" drive - Breaker bar 3/8" drive
--	---	---	--
- See table for installation location and requirements

LinQ 4.2 Gal (16 L) Cooler	Commander, Commander MAX, Maverick Trail, Maverick Sport, Maverick Sport MAX	219400964 · Black 295100698 · Gray
-----------------------------------	---	---



- All the benefits of LinQ—simple, fast and secure.
- Rotomolded construction for exceptional rigidity and durability.
- Premium-quality foam insulation for optimal ice retention.
- Uses LinQ mounting system (Patent US 8777531 and US 8875830).
- Easy one-second on/off tool-less system.
- See table for installation location and requirements.

LinQ 4.5 Gal (17 L) Sport Bag	Commander, Commander MAX, Maverick Trail, Maverick Sport, Maverick Sport MAX	860202447
--------------------------------------	---	------------------



- 17-liter (4.5 US gallon, 1,037 cu. in.) capacity.
- Rigid bottom, semi-rigid top.
- See table for installation location and requirements.

SR 5.5 Gal (21 L) LinQ BagCommander, Commander MAX,
Maverick Trail, Maverick Sport, Maverick Sport MAX**860202449**

- All the benefits of LinQ—simple, fast and secure.
- Semi-rigid expandable bag.
- 5.5 gal (21 L) capacity.
- Utilizes LinQ mounting system (Patent US 8777531 and US 8875830).
- Easy one-second on/off tool-less system.
- See table for installation location and requirements.

LinQ Roll-Top BagCommander, Commander MAX,
Maverick Trail, Maverick Sport, Maverick Sport MAX**715008110**

- Fully waterproof roll-top dry bag will securely store and confine your equipment.
- LinQ mounted using heavy-duty rigid plastic base.
- High capacity storage solution (40 L).
- Bottom foam liner for additional equipment protection.
- Integrated handle for easy transportation on/off the vehicle.
- See table for installation location and requirements.

LinQ Accessories with 36" base**LinQ Premium Storage Bag by OGIO**Commander, Commander MAX,
Maverick Trail, Maverick Sport, Maverick Sport MAX**715002923** · Black

- Tool-less installation and removal thanks to the LinQ system.
- 17.2 gal (65 L) capacity semi-rigid cargo bag ideal for carrying anything you need on your vehicle.
- Buckle and elastic closure with a rubber seal that protects dust from entering the bag.
- 3-section lid for partial or full access to your bag.
- Inside separators for optimal bag organization.
- See table for installation location and requirements.

LinQ 12 Gal (45 L) Cargo BoxCommander, Commander MAX,
Maverick Trail, Maverick Sport, Maverick Sport MAX**715003879**

- LinQ mounted for easy-on, easy-off installation.
- Holds cargo safely and securely while riding.
- See table for installation location and requirements.

LinQ 23 Gal (86 L) Trunk BoxCommander, Commander MAX,
Maverick Trail, Maverick Sport, Maverick Sport MAX**715004923**

- LinQ mounted for easy-on, easy-off installation.
- Holds cargo safely and securely while riding.
- See table for installation location and requirements.

LinQ 11.5 Gal (43 L) Audio Cargo Box

Maverick Trail, Maverick Sport, Maverick Sport MAX

715003018

- An affordable and quick solution for adding music and storage to your next ride.
- The rear installation does not use up any cab space and allows easy listening at an average speed.
- Mounts on/off easily to hold/carry cargo safely and securely.
- Backlit control panel perfect for night riding.
- Water-resistant speakers.
- The Bluetooth[®] enabled receiver and 6.5" (16.5 cm) speakers are smartly concealed and integrated in the cover.
- Automatic shut-off function protects your battery by turning the system off after 10 minutes of inactivity.
- See table for installation location and requirements.

LinQ 8 Gal (30 L) Cooler Box

Commander, Commander MAX,
Maverick Trail, Maverick Sport, Maverick Sport MAX

■ **715004778** · Black
■ **715004698** · Gray



- LinQ mounted for easy-on, easy-off installation.
- Rotomolded construction provides exceptional rigidity and durability.
- Premium-quality foam insulation for optimal ice retention.
- Integrated, fully removable compartment protects food.
- Robust rubber latches keep the cover tightly closed.
- Weather-resistant.
- Convenient drain plug.
- See table for installation location and requirements.

LinQ 32 Gal (121 L) Trunk Box

Maverick Trail, Maverick Sport, Maverick Sport MAX

715001747 · Black
(Rear tail light included)

European Version (EC compliant)

715001748 ·
(No rear tail light)



- Equipped with the LinQ System, the rear trunk box plugs in and out in seconds.
- 32 gal (121 L) load capacity with unobstructed space to maximize storage room and access to the trunk's interior.
- Made of injection-molded polyethylene, double walled in critical areas.
- The fully sealed lid protects your belongings from dust, moisture and the elements.
- Trunk Box Panels available in many colours to match your vehicle (sold separately).
- See table for installation location and requirements.

LinQ 32 Gal (121 L) Trunk Box Panels

Maverick Trail, Maverick Sport, Maverick Sport MAX

- Colour panels to match the LinQ 32 gal (121 L) to your vehicle (715001747 / 715001748).

■ **715001391** · Black
■ **715001392** · Yellow
■ **715001395** · Viper Red
■ **715002481** · White
■ **715002480** · Light Gray
■ **715002984** · Octane Blue

■ **715002985** · Manta Green
■ **715002986** · Can-Am Red
■ **715006119** · Orange Crush
■ **715006120** · Squadron Green
■ **715007074** · Tundra Green

European Version (EC compliant)
No rear tail light

■ **715001397** · Black
■ **715001398** · Yellow
■ **715002483** · White

■ **715006121** · Can-Am Red
■ **715006122** · Manta Green
■ **715006123** · Orange Crush
■ **715006124** · Viper Red

LinQ Heavy-Duty Basket

Commander, Commander MAX,
Maverick Trail, Maverick Sport, Maverick Sport MAX

715001215



- Made of high-strength, low-alloy steel.
- LinQ mount for easy-on, easy-off installation.
- See table for installation location and requirements.

LinQ Low Profile Basket

Commander, Commander MAX,
Maverick Trail, Maverick Sport, Maverick Sport MAX

715004282



- Low profile, open basket increases cargo space.
- Perfect for easy access to tools, rope, winch and plow accessories.
- Multiple bungee cord and tie-down anchor points.
- Made of impact-resistant injected polypropylene.
- See table for installation location and requirements.

LinQ Holders

LinQ Tool Holder

Commander, Commander MAX,
Maverick Trail, Maverick Sport, Maverick Sport MAX

715007358



- Ultra-versatile tool holder.
- Convenient swivel-latch allows tools to be stored in any orientation.
- Sold in pairs.
- See table for installation location and requirements.

LinQ Gear Grips

Commander, Commander MAX,
Maverick Trail, Maverick Sport, Maverick Sport MAX

715005340



- Durable and flexible grips provide a custom fit for a variety of items from 1" to 4" (2.5 cm to 10 cm) in diameter.
- Heavy-duty design for carrying bows, fishing poles, rakes, farm tools and more.
- Quick-release button opens grip quickly for easy access to gear.
- Heavy-duty base system built for the toughest adventures.
- Make transporting your tools a snap by combining the Gear Grips with the LinQ System.
- 360° orientation.
- Sold in pairs.
- See table for installation and requirements.

LinQ Accessories

LinQ Adapter

(Not illustrated)

Commander, Commander MAX,
Maverick Trail, Maverick Sport, Maverick Sport MAX

715003058

- Sold in pack of 4.

LinQ Base Installation Kit

Commander, Commander MAX,
Maverick Trail, Maverick Sport, Maverick Sport MAX

715008125



- Unique mounting fastener usable on any LinQ System accessory.
- Included: 2 Cargo LinQ bases and hardware.

LinQ Lock

Commander, Commander MAX,
Maverick Trail, Maverick Sport, Maverick Sport MAX

860201968



- Simple way to securely lock most LinQ accessories.
- Lock cover protects lock from the elements.
- Corrosion resistant.
- Pack of 1, includes 2 keys.
- Not compatible with LinQ 4.2 US gal (16 L) Cooler, LinQ Tool Box, LinQ Tool Holder and LinQ Gear Grips.

LinQ Replacement Part

Maverick Trail, Maverick Sport, Maverick Sport MAX

715001707



- Unique mounting fastener usable on any LinQ System accessory.
- Tool-less installation and removal.
- Sold in pairs.

LinQ Anchor Adapter kit

Maverick Trail, Maverick Sport, Maverick Sport MAX

715004960



- Allows the installation of LinQ accessories with 16" base on LinQ racks.
- Tool-less installation and removal.
- LinQ pivoting rack is required for installation.

LinQ Passenger Seat Base Kit

Commander, Commander MAX,
Maverick Trail, Maverick Sport, Maverick Sport MAX

715003951



- LinQ base kit that installs on the passenger seat frame underneath the bottom seat cushion.
- Allows installation of compatible LinQ accessories inside the cabin.
- Passenger seat cushion can be reinstalled over the LinQ base kit when not in use.

CARGO & STORAGE

Cargo

LinQ Cargo Rack

Commander, Commander MAX

715006815

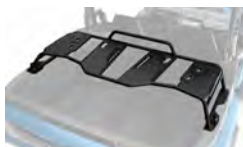

- Strong, durable steel rack 7/8".
- Easy and tool-less installation with LinQ system.
- Allows the installation of LinQ accessories.
- Allows multi-level storage on cargo bed.
- Helps keep cargo securely in place.
- Multiple bungee cord and tie-down points.
- Kit includes LinQ Base 36".
- 15" clearance under the rack for other cargo.
- Not compatible with 715006816.

Integrated Tailgate Extension

Commander, Commander MAX

715006810



- Integrated design that lets the extension fold away inside the tailgate when not needed.
- Steel construction for rugged durability.
- Not EC compliant.

Tonneau Cover	Commander, Commander MAX	715006816
	<ul style="list-style-type: none"> ▪ Fitted to cover all of the items in your cargo box. ▪ Prevents splash from entering the cargo box. ▪ Rolls up to the front. ▪ Easily removable for quick access. ▪ Not compatible with accessories that exceed the bed height. 	
All-Terrain Trunk Cover	Maverick Trail, Maverick Sport (except X mr), Maverick Sport MAX	715003701
	<ul style="list-style-type: none"> ▪ Transforms your rear cargo area into a fully enclosed and weather-resistant car-like trunk box. ▪ Gas spring assisted opening. ▪ Integrated mounting location inside the trunk cover for Dome Light (715002455) (sold separately). ▪ Rotomolded construction provides exceptional rigidity. ▪ LinQ accessories can be installed on or inside the trunk cover. ▪ LinQ Base Installation Kit required for installation on the trunk cover. 	
Fixed Tailgate	Maverick Trail, Maverick Sport, Maverick Sport MAX	715004357
	<ul style="list-style-type: none"> ▪ Rigid rotomolded construction. ▪ Encloses perfectly the rear cargo opening and helps keep cargo securely in place. ▪ Matches the vehicle's styling. 	
Storage		
Storage 2.6 Gal (10 L) Bag	Commander, Commander MAX, Maverick Trail, Maverick Sport, Maverick Sport MAX	269502121
	<ul style="list-style-type: none"> ▪ Roll-Top dry bag for fully protecting your cargo from the elements. 	
Soft Storage Bag	Commander, Commander MAX, Maverick Trail, Maverick Sport, Maverick Sport MAX	715003759
	<ul style="list-style-type: none"> ▪ 11.8 gal (45 L) capacity soft cargo bag designed with vehicle's rear in mind to maximize potential storage. ▪ 3-section bag. ▪ Transport gear in a weatherproof bag. 	
Overhead Storage Bags	Commander, Commander MAX, Maverick Trail, Maverick Sport, Maverick Sport MAX	715005018
	<ul style="list-style-type: none"> ▪ Weather-resistant bags, hold your gear safely and securely while riding. ▪ Include 2 overhead soft bags mounted on a tubular frame that sits between cage and roof. ▪ 2.4 gal (9 L) total capacity. ▪ Bimini Roof with sun visor or Sport Roof needed for installation. ▪ Not compatible with the Complete Wet Sounds Audio System. 	
Shoulder Storage Bag	Commander, Commander MAX, Maverick Trail, Maverick Sport, Maverick Sport MAX	715005019
	<ul style="list-style-type: none"> ▪ Weather-resistant semi-rigid bag holds your gear safely and securely while riding. ▪ Bag attaches in unused space between the seats to increase your vehicle's cargo capacity. ▪ 2.8 gal (10.5 L) capacity. 	

Removable Central Storage Bag	Commander MAX, Maverick Sport MAX	715004794
	<ul style="list-style-type: none"> • Weather-resistant bag holds your gear safely and securely while riding. • Both front and rear passengers can access the bag's content. • Designed as a 1.3 gal (5.2 L) capacity pocket, also equipped with inner netting compartments and side pockets. • Can be removed in seconds and includes shoulder strap for transportation. • Perfect to bring your gear on and off your vehicle. 	

Soft Cooler	Commander, Commander MAX, Maverick Trail, Maverick Sport, Maverick Sport MAX	715003728
	<ul style="list-style-type: none"> • Soft cooler made of durable canvas. • Removable shoulder strap and carry handles. • Foam insulation and water-resistant interior liner. • 2.2 gal (4.5 L) capacity. 	

RACKS & HOLDERS









Adventure Roof Rack	Commander MAX, Maverick Sport MAX	715004095
	<ul style="list-style-type: none"> • Ideal cargo solution for packing everything you need to live your off-road experience fully and completely. • Built with heavy-duty 1.5" (3.8 cm) and 1.25" (3.2 cm) diameter steel tubing. • Loads of up to 75 lb (34 kg). • LinQ support plates allow for installation of accessories with 16" base. 	<ul style="list-style-type: none"> • Integrated mounting points for the installation of the 39" (99 cm) Double Stacked LED Bar (front). • Features anchor points for spare tyre attachment. • Spare Tyre Tie-Downs sold separately. • Add the Cargo Box Net to secure and confine your cargo in the rack. • Can be installed without a roof or with Sport Roof only.

Rear Adventure Rack	Commander, Commander MAX	715006809
	<ul style="list-style-type: none"> • Made of heavy-duty steel. • Increases the cargo versatility of the vehicle. • Allows a Commander 2-up to fit a MAX Sport Roof or Bimini Roof on top to protect the cargo area. 	<ul style="list-style-type: none"> • Allows a Commander 2-up to fit MAX Adventure Roof Rack to increase cargo capacity. • Not compatible with other bed installed accessories.

Adventure Rack Enclosure	Commander Commander MAX	715006818 715008246
	<ul style="list-style-type: none"> • Works with Rear Adventure Rack. • Rear-panel zip-type windows with roll-down feature. • Inside and outside anti-corrosion coating with durable powder-coat finish. • Compatible only with Sport Roof. 	<ul style="list-style-type: none"> • Compatible with Track Kit and Pre-filter only in Pickup configuration. • Track Kit and Pre-filter are not compatible with the SUV configuration. • Not compatible with snorkel kits or X mr models.

Cargo Bed Rails	Commander, Commander MAX	715006824
	<ul style="list-style-type: none"> • Add an integrated tie-down area to your cargo box. • Added cargo box protection. • Inside and outside anti-corrosion coating with durable powder-coat finish. 	<ul style="list-style-type: none"> • Heavy-duty 1" (2.5 cm) diameter steel tube construction. • Adds height to the bed side wall and serves as a tie-down point. • Sold in pairs.

Deluxe Headache Rack	Commander, Commander MAX (except X mr models)	715006823
	<ul style="list-style-type: none"> • Protects cab from cargo load. • Compatible with cargo bed rails. • Not compatible with Snorkel Kit (715003705). 	

LinQ Pivoting Rack	Maverick Trail, Maverick Sport, Maverick Sport MAX	715008297
	<ul style="list-style-type: none"> LinQ latched rack allows for extra LinQ mounted accessories or the addition of ATV LinQ rack extensions. Includes custom tie-down strap for fast spare tyre installation or removal (tyre not included). Gas-cylinder pivot action, locks in the raised position. Not compatible with Gear Rail (715003703), Lonestar Racing and DragonFire tyre carrier, Lonestar Racing Number Plate, Rear Intrusion Bars and LinQ Cargo Rack. Compatible with the All-Terrain Trunk Cover. 	
Front Rack	Maverick Trail, Maverick Sport, Maverick Sport MAX	715004302
	<ul style="list-style-type: none"> Rugged looking front rack mounts on top of vehicle hood and provides additional protection and cargo capacity. Heavy-duty 3/4" (1.9 cm) diameter steel-tube construction. 50 lb (22.7 kg) load capacity. Inside and outside anti-corrosion coating with durable powder coat finish. Flip-up configuration provides easy access to service area. Not compatible with DragonFire Front Exo-Frame. 	
LinQ Rack Extension	Maverick Trail, Maverick Sport, Maverick Sport MAX	715003771
	<ul style="list-style-type: none"> Made of strong and durable die-cast aluminum. Helps to keep cargo securely in place. Easy and tool-less installation thanks to the LinQ System. 	
LinQ Cargo Rack	Maverick Trail, Maverick Sport, Maverick Sport MAX	715003702
	<ul style="list-style-type: none"> Made of durable die-cast aluminum and strong aluminum tubing frame. Allows the installation of LinQ Trunk Boxes on top and the addition of more LinQ accessories in cargo box. Easy and tool-less installation thanks to the LinQ System. 	
Spare Tyre Carrier	Maverick Trail, Maverick Sport, Maverick Sport MAX	715004471
	<ul style="list-style-type: none"> Holds spare tyre in place. Designed for fast tyre removal. Can hold tyres up to 30" in diameter (tyre is not included). Rear bumper mounted, does not encumber the cargo area. Made of heavy-duty 1.5" (3.8 cm) diameter steel tubing. Inside and outside anti-corrosion coating with durable powder coat finish. Requires Rear Trail Bumper (715007109) or Rear Rancher Bumper (715004304). 	
Cargo Box Net	Commander, Commander MAX, Maverick Sport MAX	715001371
	<ul style="list-style-type: none"> Solid net designed to secure and ensure the compact confinement of your Adventure Roof Rack. 	
LinQ Tool and Gun Holder	Commander, Commander MAX	715005466
	<ul style="list-style-type: none"> 2-in-1 holding rack can be used both on the job or on the hunt. Include 5 locations to securely hold tools and guns using rubber grips and retention straps at the top and a rubber mat with gunstock shaped molding at the bottom. Easy to remove, install or reposition using our simple and secure LinQ system. Can be attached at multiple positions along the cargo bed walls, facing inside or outside the bed. Can be attached on the inside of the cargo, behind the cab. Not compatible with Headache Rack. 	
LinQ Gun Case	Commander, Commander MAX, Maverick Trail, Maverick Sport, Maverick Sport MAX	715004968
	<ul style="list-style-type: none"> Practical design allows you to store shotguns and rifles up to 52" (132 cm) even with optics. Adapt to different weapon shapes and features with foam cushions that can be repositioned. LinQ-mounted for efficient and secure storage, locked in place with only a quarter turn. No mount required on Commander and Commander MAX. Mount kit required for Maverick Trail, Maverick Sport and Maverick Sport MAX. 	

LinQ Gun Case Mounting Kit	Maverick Sport, Maverick Sport MAX, Maverick Trail	715006444
	<ul style="list-style-type: none"> • Required to install the Can-Am Gun Case on a Maverick Sport, Maverick Sport MAX and Maverick Trail. • Allows you to install up to two LinQ gun cases. 	
Stronghold Gun Boot Impact[†] by Kolpin[†]	Maverick Trail, Maverick Sport, Maverick Sport MAX	705011442
	<ul style="list-style-type: none"> • Compact low-profile design with Kolpin Stronghold styling securely holds up to 52" (132 cm) long rifles and shotguns with optics. • Includes a removable, shock absorbing foam Impact liner. • Single-handed opening with an attached lid for quick access along with an integrated closure strap. • For use with the Kolpin Stronghold Auto-Latch Mount System. 	
Stronghold Auto-Latch Mount by Kolpin	Maverick Trail, Maverick Sport, Maverick Sport MAX	715003899
	<ul style="list-style-type: none"> • Auto-latching design provides quick and secure gun boot attachment to your vehicle. • Bracket is made from rugged high-impact, reinforced nylon and coated steel. • For use with Stronghold Gun Boot (705011442). • Requires Gear Rail (715003703). 	
Gear Rail	Maverick Trail, Maverick Sport, Maverick Sport MAX	715003703
	<ul style="list-style-type: none"> • Sturdy gear rail design with C-clamps attached on the roll cage. • Offers mounting points for the Stronghold Auto-Latch Mount or for the Universal Saw Press by Kolpin. • Can hold up to two gun boots. • Not compatible with the Gun Boot 6.0 Impact by Kolpin (715001419). 	
Universal Saw Press by Kolpin	Maverick Trail, Maverick Sport, Maverick Sport MAX	715001423
	<ul style="list-style-type: none"> • Specially crafted for transporting your chainsaw securely and safely aboard your side-by-side vehicle. • Heavy-duty, black powder-coated metal bracket designed to attach any chainsaw model with up to a 20" (51 cm) bar. • Rubber pads provide cushion and tight fit. • Hinged design for quick removal. • Holds saw in vertical position or 45° angle in either direction. • Requires Gear Rail (715003703). • Protective sheath included. 	
Spare Tyre Ratchet Tie-Downs	Commander, Commander MAX, Maverick Trail, Maverick Sport, Maverick Sport MAX	280000955
	<ul style="list-style-type: none"> • 3-way ratcheting tie-down strap with loop ends. • Designed to securely hold spare tyres on accessories equipped with integrated spare tyre attachment points. • Adjustable to accommodate most common UTV tyre sizes. • Ratchet and junction ring made of durable zinc-plated steel. • Required for spare tyre attachment on Adventure Roof Rack and LinQ Pivoting Rack. 	
Heavy-Duty Ratchet Tie-Down	Commander, Commander MAX, Maverick Trail, Maverick Sport, Maverick Sport MAX	715008308
	<ul style="list-style-type: none"> • 1,000 lb (454 kg) safe working load. • 1.5 in. x 6 in. (38 mm x 1.8 mm) strap with BRP brands. • Deluxe ratchet with rubber handle. • Black-coated clip hooks. • 12" (300 mm) webbing included. • Pack of two. 	
Bolt-On[†] Retractable Ratcheting Tie-Downs	Commander, Commander MAX, Maverick Trail, Maverick Sport, Maverick Sport MAX	295101072
	<ul style="list-style-type: none"> • Perfect for transporting your powersport vehicle or securing loads. • Mounts easily: Bolts on any flat surface (e.g., truck bed or frame). • 1" x 6' (2.5 cm x 1.8 m) tie-down strap with heavy-duty stitching that delivers a 500 lb (226 kg) working load strength and 1,500 lb (680 kg) break strength. • Convenient retractable push button automatically slackens, spools and stores away strap, while the ratchet mechanism tightens the strap snugly to secure your vehicle or load into place. • Rubber ratcheting handle provides firm grip, and the hook is vinyl coated to protect whatever surface it hooks into. • Sold in pairs. 	
Ratchet Tie-Downs	Commander, Commander MAX, Maverick Trail, Maverick Sport, Maverick Sport MAX	715008309 · Black/Gray
	<ul style="list-style-type: none"> • 400 lb (181 kg) safe working load. • 1" x 10' (2.5 cm x 3 m) strap with Sea-Doo, Ski-Doo and Can-Am logos. • Deluxe ratchet with rubber handle. • Coated S hooks. • Pack of 2. 	

LIGHTS

2 Choose your lights

1 Choose your mount point	BAJA DESIGNS LIGHTS				CAN-AM LIGHTS				
	10" (25 cm) LED light bar	XL Sport LED lights (sold in pairs)	Squadron Sport LED lights (sold in pairs)	XL80 LED lights (sold in pairs)	10" double stacked LED bar	15" double stacked LED bar	39" double stacked LED bar	4" round LED lights (sold in pairs)	3.5" spot or flood LED lights (sold in pairs)
	Consult p. 147 information on Baja Designs lights.				Consult p. 148 for information on Can-Am lights.				
XT & X mr Front Bumper <i>(Stock on XT, XT-P and X mr)</i>	710006819 + 715007049 (Power Cable)	710006821 + 715002884 (Power Cable)	710006820 + 715002884 (Power Cable)	710005041 + 715007049 (Power Cable)	715002933 + 715003670 (Power Cable)	715002934 + 715003670 (Power Cable)	NA	715002935 (4" Round), 715003665 (3.5" Flood) or 715003666 (3.5" Spot) + 715003670 (Power Cable)	
Trail Bumper & Rancher Bumper	NA	710006821 + 715002884 (Power Cable)	710006820 + 715002884 (Power Cable)	710005041 + 715007049 (Power Cable)	715002933 + 715003670 (Power Cable)	NA	NA	715002935 (4" Round), 715003665 (3.5" Flood) or 715003666 (3.5" Spot) + 715003670 (Power Cable)	
DragonFire Racing Front Bumper	NA	NA	NA	NA	715002933 + 715003670 (Power Cable)	NA	NA	715002935 (4" Round), 715003665 (3.5" Flood) or 715003666 (3.5" Spot) + 715003670 (Power Cable)	
Commander Front Bumper	710006819 + 715007049 (Power Cable)	710006821 + 715002884 (Power Cable)	710006820 + 715002884 (Power Cable)	710005041 + 715007049 (Power Cable)	NA	715002934 + 715003670 (Power Cable)	NA	715002935 (4" Round), 715003665 (3.5" Flood) or 715003666 (3.5" Spot) + 715003670 (Power Cable)	
Sport Roof & Bimini Roof	710006819 + 715007049 (Power Cable) <i>*Optional Overhead Switch Panel</i> 715003669	710006821 + 715002884 (Power Cable) <i>*Optional Overhead Switch Panel</i> 715003669	710006820 + 715002884 (Power Cable) <i>*Optional Overhead Switch Panel</i> 715003669	710005041 + 715007049 (Power Cable) <i>*Optional Overhead Switch Panel</i> 715003669	715002933 + 715003670 (Power Cable) 715003669 (Overhead Switch Panel)	715002934 + 715003669 (Overhead Switch Panel)	715004007 + 715005822 (Mounting Kit) <i>*Optional Overhead Switch Panel</i> 715003669	715002935 (4" Round), 715003665 (3.5" Flood) or 715003666 (3.5" Spot) + 715003669 (Overhead Switch Panel)	
Top Roll Cage & DragonFire Aluminum Roof	NA	NA	NA	NA	NA	NA	715004007 + 715005822 (Mounting Kit)	NA	NA
Lonestar Racing Aluminum Roof	NA	NA	NA	NA	NA	NA	715004007 + 715004877 (Light Mounts) and 715005822 (Mounting Kit)	NA	NA
Sport Roof Back Position	NA	NA	NA	NA	NA	NA	NA	NA	715003665 or 715003666 + 715003669 + 715004910

3 Order

Order all part numbers in intersecting box
**Note: When installing more than one light kit, additional light power cable or mounting kit is required.*

*All lights are intended for Off-Road use only.

Baja Designs Light Power Cable <i>(Not illustrated)</i>	Commander, Commander MAX, Maverick Trail, Maverick Sport, Maverick Sport MAX	715002884
<ul style="list-style-type: none"> • Required for installation of Baja Designs LED lights onto roof or bumper. • Baja Designs XL Sport LED Lights and Baja Designs Squadron Sport LED Lights. 		
Baja Designs Light Power Cable <i>(Not illustrated)</i>	Commander, Commander MAX, Maverick Trail, Maverick Sport, Maverick Sport MAX	715007049
<ul style="list-style-type: none"> • Required for installation of Baja Designs LED lights onto roof or bumper. • 10" (25 cm) Baja Designs OnX6 LED Bars and Baja Designs XL80 LED Lights. 		

Baja Designs 10" (25 cm) OnX6 LED Light Bar

Commander, Commander MAX, Maverick Trail, Maverick Sport, Maverick Sport Max

710006819



12,460 lumens

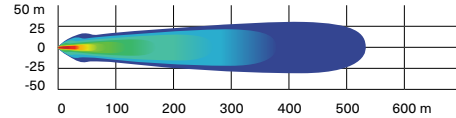

- 108 W light bar producing 12,460 lumens.
- Equipped with 6 Cree XM-L2 LEDs.
- Driving/combo light pattern for smooth blend of light for both near field applications and distance.
- Dual intensity (high/low) settings.
- Requires Baja Designs Light Power Cable.
- See table for installation location and requirements.

Baja Designs XL80 LED Lights

Commander, Commander MAX, Maverick Trail, Maverick Sport, Maverick Sport MAX

710005041



9,500 lumens

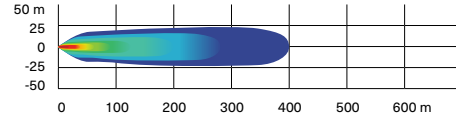

- 80 W per spot producing 9,500 lumens.
- Equipped with 4 Cree XHP50 LEDs per spot.
- Dual intensity (high/low) settings.
- Driving/combo light pattern for smooth blend of light for both near field applications and distance.
- Require Baja Designs Light Power Cable.
- Sold in pairs.
- Dimensions: 4.5" x 4.5" (11.4 cm x 11.4 cm).

Baja Designs Squadron Sport LED Lights

Commander, Commander MAX, Maverick Trail, Maverick Sport, Maverick Sport MAX

710006820



3,150 lumens

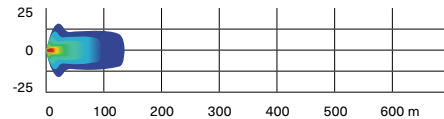

- 26 W per spot producing 3,150 lumens.
- Equipped with 4 Cree XP-G2 LEDs per spot.
- Wide cornering light pattern designed specifically for cornering, dust and/or fog conditions.
- Require Baja Designs Light Power Cable.
- Sold in pairs.
- Dimensions: 3" x 3" (7.6 cm x 7.6 cm).

Baja Designs XL Sport LED Lights

Commander, Commander MAX, Maverick Trail, Maverick Sport, Maverick Sport MAX

710006821



3,150 lumens

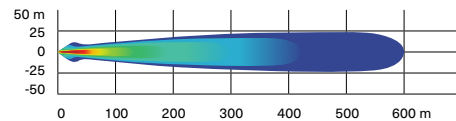

- 26 W per spot producing 3,150 lumens.
- Equipped with 4 Cree XP-G2 LEDs per spot.
- High Speed Spot features a longer and narrower beam focus for illumination farther down.
- Require Baja Designs Light Power Cable.
- Sold in pairs.
- Dimensions: 4.5" x 4.5" (11.4 cm x 11.4 cm).

10" (25 cm) Double Stacked LED Light Bar (60 W)

Commander, Commander MAX, Maverick Trail, Maverick Sport, Maverick Sport MAX

715002933



5,400 lumens

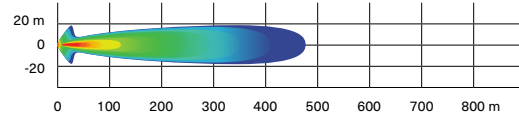

- Equipped with twelve 5 W Cree LEDs.
- 5,400 lumens.
- Packs a big punch for its size.
- Rugged and waterproof.
- Can be installed in stock XT and XT-P bumpers.
- Requires light power cable for installation.
- Lights up to more than 1,500 ft (460 m) in front of the vehicle and around 65 ft (20 m) wide on each side.
- EC compliant.

15" (38 cm) Double Stacked LED Light Bar (90 W)

Commander, Commander MAX,
Maverick Trail, Maverick Sport, Maverick Sport MAX

715002934



8,400
lumens

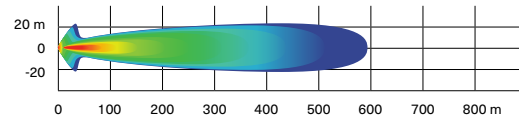

- Equipped with 18 5 W Cree LEDs.
- 8,400 lumens.
- Complements the Light Racks and most bumpers.
- Rugged and waterproof.

- Lights up to more than 1900 ft (580 m) in front of the vehicle and around 65 ft (20 m) wide on each side.
- EC compliant.

39" (99 cm) Double Stacked LED Light Bar (270 W)

Commander, Commander MAX,
Maverick Trail, Maverick Sport, Maverick Sport MAX

715004007



24,300
lumens

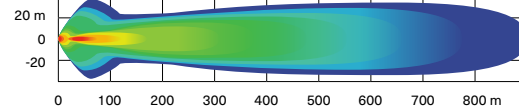

- Equipped with 54 5 W Cree LEDs.
- 24,300 lumens.
- Lights up to more than 2,900 ft. (900 m) in front of the vehicle and around 115 ft. (35 m) wide on each side.
- Compatible on the Adventure Roof Rack.

- Maverick Trail, Maverick Sport, Maverick Sport MAX: Requires Light Mounting Kit for 39" (99 cm) LED Light Bar (715005822) and/or Lonestar Racing Mounts for 39" (99 cm) Double Stacked LED Light Bar (715004877) for installation.
- Commander 2021 & up: Requires Light Mounting Kit for 39" (99 cm) LED Light Bar (715005822) and/or Lonestar Racing Mounts for 39" (99 cm) Double Stacked LED Light Bar (715004877) for installation.

4" (10 cm) Round LED Lights (2 x 25 W)

Commander, Commander MAX,
Maverick Trail, Maverick Sport, Maverick Sport MAX

715002935



1,800
lumens

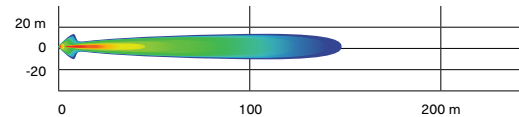

- 25 W LED spotlights.
- 1,800 lumens.
- Rugged and waterproof.
- Includes basic wiring and switch.

- Can-Am branded grill.
- Requires light power cable.
- Sold in pairs.
- Not EC compliant.

3.5" (9 cm) LED Driving Lights (2 x 14 W)

Commander, Commander MAX,
Maverick Trail, Maverick Sport, Maverick Sport MAX

715003666



1,260
lumens

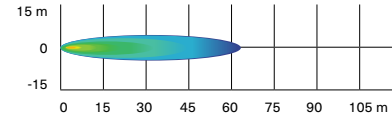

- 14 W LED lights producing 1,260 lumens each.
- Spot lens for a narrow and long light beam spread, ideal when driving at higher speeds.
- Equipped with six high-power LEDs in a heavy-duty die-cast aluminum housing.

- Features two attachment points. If one attachment point fails due to a collision, rotate to the next channel point and remount the light.
- Sold in pairs.
- EC compliant.

3.5" (9 cm) LED Flood Lights (2 x 14 W)

Commander, Commander MAX,
Maverick Trail, Maverick Sport, Maverick Sport MAX

715003665



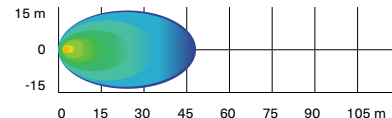

1,260
lumens



- 14 W LED lights producing 1,260 lumens each.
- Flood lens for a wide light beam spread, ideal for working applications like plowing or cornering. Suitable for dusty or foggy riding conditions.
- Equipped with six high-power LEDs in a heavy-duty die-cast aluminum housing.

- Features two attachment points. If one attachment point fails due to a collision, rotate to the next channel point and remount the light.
- Sold in pairs.
- EC compliant.

Light Power Cable <i>(Not illustrated)</i>	Commander, Commander MAX, Maverick Trail, Maverick Sport, Maverick Sport MAX	715003670
<ul style="list-style-type: none"> • Power cable for installation of compatible Can-Am light kits on Front Bumpers or roof. 		
LED Headlights Assembly	Commander, Commander MAX, Maverick Trail, Maverick Sport, Maverick Sport MAX	715003667
	<ul style="list-style-type: none"> • The headlights in this upgrade kit draw a maximum of 40 W (2 x 20 W) of power while providing brighter light output. • Lower power consumption and longer lasting than standard halogen bulbs. 	
LED Signature Lights	Commander, Commander MAX	715006896
	<ul style="list-style-type: none"> • The stylish LED set adds a finishing touch, accentuating its aggressive stance. 	
Can-Am LED Signature Lights	Maverick Trail, Maverick Sport, Maverick Sport MAX	715003673
	<ul style="list-style-type: none"> • Add style with a more aggressive look. • Use bright and energy efficient LEDs. • Do not give additional lighting for driving. 	
Dome Light	Commander, Commander MAX, Maverick Trail, Maverick Sport, Maverick Sport MAX	715002455
	<ul style="list-style-type: none"> • LED array integrates perfectly with vehicle. • Wiring included. • Can be installed on cage, Sport Roof or All-Terrain Trunk Cover. 	
Lonestar Racing Mounts for 39" (99 cm) Double Stacked LED Light Bar	Commander, Commander MAX, Maverick Trail, Maverick Sport, Maverick Sport MAX	715004877
	<ul style="list-style-type: none"> • Low profile mounts allowing for the installation of the 39" (99 cm) Double Stacked LED Light Bar on the Lonestar Racing Aluminum Roof (sold separately). 	
Mounting Kit for 39" (99 cm) LED Light Bar <i>(Not illustrated)</i>	Commander, Commander MAX, Maverick Trail, Maverick Sport, Maverick Sport MAX	715005822
<ul style="list-style-type: none"> • Required for installation of the 39" (99 cm) double stacked LED Light Bar. • Includes wiring and support bracket. • Light Support Bar required for installation. 		
Roof Power Cable <i>(Not illustrated)</i>	Commander, Commander MAX, Maverick Trail, Maverick Sport, Maverick Sport MAX	715003094
<ul style="list-style-type: none"> • Brings power from the battery. • Required for installation of some electrical accessories. 		
Rear Lights Power Cable <i>(Not illustrated)</i>	Commander, Commander MAX, Maverick Trail, Maverick Sport, Maverick Sport MAX	715004910
<ul style="list-style-type: none"> • Power cable that allows you to install rear cargo lights on your vehicle. • Use in conjunction with the 3.5" (9 cm) LED Flood Lights (2 x 14 W) (sold separately). • This set-up will illuminate your rear cargo area and surroundings. • Sport Roof and Overhead Switch Panel (715003669) required. 		

AUDIO & COMMUNICATION SYSTEMS

Audio

Complete Wet Sounds⁺ Audio System

Commander, Commander MAX,
Maverick Trail, Maverick Sport, Maverick Sport MAX

715003672



- Orchestrated for outstanding sound quality and the playlists of champions.
- Built-in 200 W amplifier with D-Bass Tech for improved low end bass response.
- Built-in Bluetooth[®] connectivity with source control.
- Aux input allows for use with non-Bluetooth devices.
- Turns itself off after 10 minutes of inactivity to save battery power.
- Designed to be Can-Am-tough in the most demanding riding conditions.
- Includes 4.5" (11.4 cm) front and 6.5" (16.5 cm) rear-roll-cage mounted stereo speakers and console integrated backlit control panel.

Wetsound Stealth XT 6 Can-Am Edition Sound Bar

Commander, Commander MAX,
Maverick Trail, Maverick Sport, Maverick Sport MAX

715008282



- Built-in Bluetooth connectivity with source control.
- Built-in Broadcast mode.
- Backlit control panel with Integrated LED RGB cabin lights.
- Integrated LED Dome.
- IP67 rated RF wireless remote control.
- 3.5 Aux Input/Output.
- Built-in 300 W Class D Amplifier.
- 4 marine-rated 3" full range drivers.
- 2 marine-rated 1" tweeters.
- Operating voltage: 12 V.
- IP rated: IP67.
- Length: 21.31"
- Width: 4.04'
- Height: 3.85"
- Sound Bar Mounting Kit required for installation.

Sound Bar Mount Kit

(Not illustrated)

Commander, Commander MAX,
Maverick Trail, Maverick Sport, Maverick Sport MAX

715004745

- Required mount kit for the Wet Sounds Stealth 6 Ultra HD Can-Am Edition Sound Bar (715008282).

Can-Am Subwoofer

Commander, Commander MAX,
Maverick Trail, Maverick Sport, Maverick Sport MAX

715006359



- Powerful Wet Sounds 8" Subwoofer speakerbox that fits in the glove box.
- Easy plug-and-play connections to Wet Sounds audio system.
- Sturdy construction, tough enough to withstand harsh environments and sealed against moisture and dirt.
- 350 W amplifier and wiring included.

Electronic Device Holder

Commander, Commander MAX, Maverick Trail,
Maverick Sport, Maverick Sport MAX

715005212



- A great in-ride entertainment system platform.
- Robust injected-polypropylene construction allows for right fit and easy installation.
- Adjustable unit safely holds most tablets and smartphones measuring between 5.1" (13 cm) and 10" (25.4 cm) (with protective case).
- Allows the installation of Garmin Montana 680T GPS.
- Perfectly complements the Wet Sounds audio systems or Rugged Radios Intercom System to play music with your device.
- Integrated storage (2.5 gal (9.5 L) capacity) with access to the dash 12V outlet for device charging.
- Integrated mounting location for RAM mounts.
- Not compatible with Defrost, Heat and Ventilation System (715003678).

Communication Systems

Rugged Radios Car-to-Car System

Commander, Commander MAX,
Maverick Trail, Maverick Sport, Maverick Sport MAX

715003440 · US ONLY



- Perfect for communicating with friends and family on group rides.
- Push-to-talk button conveniently mounted on the steering wheel.
- May be connected with the Rugged Radios Intercom System (with provided adapter cable).
- This kit includes:
 - 5-watt V3 radio: UHF/VHF + FM frequency, programmable channels, 5 watts of power, includes belt clip, recharging cable, high capacity, all day lithium-ion battery, 1-3 mile range, NOAA weather channels, 1-touch FM radio, backlit screen/buttons.
 - Helmet Speaker/Mic Kit: Clear Hear audio speakers, Full Flex mic boom, cloth mic cover, Velcro mount speakers, quick & easy install.
 - Harness & Cables: single person harness, driver coil cord PTT, waterproof PTT, radio mounting bracket, complete plug & play kit.

Rugged Radios Intercom System

Commander, Commander MAX[†],
Maverick Trail, Maverick Sport, Maverick Sport MAX[†]

715002891 · US ONLY



- Specifically designed to facilitate clear in-vehicle communication between driver and passenger(s).
- Expandable to 4 people.
- Includes music port for enjoying your favorite tunes.
- Seamless integration with in-dash switch panel.
- May be synched with the Rugged Radios Car-to-Car System.

[†]Power Cable (715003094) is required for installation on MAX models.

Rugged Radios Helmet Headset Kit for Rear Passengers

With Rugged Radios Intercom System

715004380 · US ONLY



- Additional 12' (3.7 m) cables and Helmet Speaker/Mic Kits to upgrade your 2-person intercom system to a 4-person system.

[†]Power Cable (715003094) is required for installation on MAX models.

ELECTRICAL & ELECTRONIC ACCESSORIES

Electrical

Defrost, Heat and Ventilation System

Commander, Commander MAX,
Maverick Trail, Maverick Sport, Maverick Sport MAX

715003678



- Best integrated system on the market with 3 ventilation speeds and in-dash adjustable temperature.
- Adjustable/directional vents.
- 5 vents specially positioned for better windshield defrosting and passenger comfort.
- Automotive-style heater core and fan for best heating performance.
- Smart-Lok equipped vehicles require Adapter Kit (715007241).
- Not compatible with the ProVent Windshield.

Heated Steering Wheel

Commander, Commander MAX,
Maverick Trail, Maverick Sport, Maverick Sport MAX

715004283



- Ruggedly constructed steering wheel designed to withstand cold conditions while channeling heat directly to your hands.
- Perfect for making hand mobility and grip readily available, e.g., hunting, manual farming.
- Replaces stock steering wheel.
- This kit includes the heated steering and in-dash switch.
- Heated Accessories Wiring Harness (710005757) is required.
- Draws a maximum of 45 W and 3.2 A at 13.5 W.

Heated Grab Bar Cover

Commander, Commander MAX,
Maverick Trail, Maverick Sport, Maverick Sport MAX

715004500



- Made tough to hold up to the stresses of rough riding, this heated cover will keep your passenger's hands warm and securely gripped during long, cold outings.
- Easy to install and remove.
- This kit includes the heated grab bar cover and in-dash switch.
- Heated Accessories Wiring Harness (710005757) is required.
- Draws a maximum of 25 W and 1.8 A at 13.5 W.

Seat Heater

Commander, Commander MAX,
Maverick Trail, Maverick Sport, Maverick Sport MAX

715006112

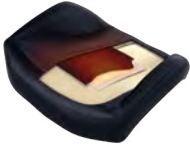

- 25 W seat heater delivers chill-free riding comfort.
- High/low temperature settings allow you to control the desired degree of warmth.
- This kit includes one carbon fiber seat heater, foam sheet and in-dash switch.
- Installs directly in the original seat cushion.
- Heated Accessories Wiring Harness (710005757) is required for front seat installation.
- Heated Accessories Wiring Harness (715006004) is required for rear seat installation.

Heated Visor Outlet

Commander, Commander MAX,
Maverick Trail, Maverick Sport, Maverick Sport MAX

715001246



- Strategically positioned on vehicle to maintain your agility.
- Optional visor outlet that delivers fog-free riding.
- Quick and easy installation.
- Sold individually.
- Heated Visor not included.

Heated Accessories Wiring Harness

(Not illustrated)

Commander, Commander MAX,
Maverick Trail, Maverick Sport, Maverick Sport MAX

710005757

- Electric harness required to hook up and operate front heated seats, heated steering wheel and heated grab bar.

Heated Accessories Wiring Harness

(Not illustrated)

Commander MAX, Maverick Sport MAX

715006004

- Electric harness required to hook up and operate rear heated seats.

Heater Adapter Kit for Smart-Lok

(Not illustrated)

Commander, Commander MAX,
Maverick Trail, Maverick Sport, Maverick Sport MAX

715007241

- Adapter kit to fit heating system on Smart-Lok equipped vehicles.

Electronic Accessories

RAM[†] GPS Mount

Commander, Commander MAX,
Maverick Trail, Maverick Sport, Maverick Sport MAX

715003325



- Allows for GPS integration onto vehicle.
- Standard AMPS hole pattern for Garmin Cradle.

USB Power Outlet Kit

Commander, Commander MAX,
Maverick Trail, Maverick Sport, Maverick Sport MAX

219400510



- Recharges your electronic devices while riding[‡] (smartphone, MP3, heating gear, etc.).
 - Dual port USB connectors.
- ‡The power outlet is not capable of recharging all device types while riding.*

Overhead Switch Panel

Commander, Commander MAX,
Maverick Trail, Maverick Sport, Maverick Sport MAX

715003669



- Fully integrated Overhead Switch Panel gives additional switch spots for electrical accessories.
- Required for Can-Am lights installation on the roof and for other top-mounted electrical accessories.
- Optional for Baja Designs lights.
- Requires Sport Roof or Bimini Roof with Sun Visor for installation.

Dual Mode Switch

Commander, Commander MAX,
Maverick Trail, Maverick Sport, Maverick Sport MAX

715004736



- Switches quickly and conveniently between normal and eco modes.
- Eco mode increases fuel economy.
- In-dash plug-and-play mount.
- Standard on DPS models.

30 Ah Battery Holder

Commander, Commander MAX,
Maverick Trail, Maverick Sport, Maverick Sport MAX

715004431



- Fixation plate designed to hold the 30 Ah Battery (515176151).
- 30 Ah Battery sold separately.

Battery Charger/Maintainer

Commander, Commander MAX,
Maverick Trail, Maverick Sport, Maverick Sport MAX

715005061



- Keeps stored lead-acid batteries charged.
- Charges and maintains small batteries.
- Microprocessor controlled multi-stage charging for added precision, safety and battery life.
- Automatically detects 6 or 12 volt batteries.
- Reverse hook-up protection helps protect battery and charger from damage.
- Auto-voltage detection.
- Press the display button to show the charge progress.
- Content: 3 amp battery charger, clamp adapter, DC adapter, 24" (61 cm) fused ring leads harness with weather cap, owner's manual.
- Not EC compliant.

Jump Starter

Commander, Commander MAX,
Maverick Trail, Maverick Sport, Maverick Sport MAX

715005062



- IPX3 water-resistant and enclosed output ports.
- 4 LED battery indicators for easy read on battery charge level.
- Compact design, will conveniently fit in your backpack, glove box or any other storage compartment.
- 2.4A + 1A / 5V USB ports for fast charging of all USB devices.
- Smart cable provides protection against reverse polarity, short circuit, low voltage, high temperature and reverse charging.
- Built-in LED light (3 modes).
- Content: 300CA jump starter, SA858 smart cable clamp, MC-USB to USB charging cable, travel bag, user manual.
- Not EC compliant.

Quick Connect Battery Cable

Commander, Commander MAX,
Maverick Trail, Maverick Sport, Maverick Sport MAX

715005408



- Quickly and easily connect and charge different batteries with your charger.
- Included in the Battery Charger/Maintainer.
- Sold individually.

Quick Connect Cable with Battery Indicator

Commander, Commander MAX,
Maverick Trail, Maverick Sport, Maverick Sport MAX

715006055



- Quickly and easily connect and charge different batteries with your charger.
- 3-colour LED indicator provides constant battery health indication.
- Sold individually.

Digitally Encoded Security System (D.E.S.S.) Keys

Commander, Commander MAX,
Maverick Trail, Maverick Sport, Maverick Sport MAX

715002458



- Top-security anti-theft protection for your vehicle.
- Encrypted chip technology restricts access to your vehicle's electronic ignition system.
- One vehicle/one code.
- A vibration/shock-resistant ball-and-socket design that ensures a reliable connection.
- 3 programmable modes:
 - Work mode: Limits vehicle speed to 40 kph (25 mph) but does not limit engine torque.
 - Normal mode: Limits vehicle speed to 70 kph (44 mph) and 50% torque reduction.
 - Performance mode: No restrictions.

WINCHES & HITCHES

Can-Am HD Winches

Can-Am HD 4500 Winch

Commander, Commander MAX,
Maverick Trail, Maverick Sport, Maverick Sport MAX

715006416



- Ergonomic clutch handle.
- Rugged all-steel gears and bushings for more torque and durability.
- Automatic 100% load-holding brake.
- Sealed solenoid for all-weather protection.
- Weather sealed corded remote and dash mounted switch.
- EC compliant.
- Pulling strength capability of 4,500 lb (2,041 kg).
- 43' of 1/8" (13.1 m of 6.3 mm) wire steel cable.
- Heavy-duty 4-way roller fairlead.
- Winch Electrical Harness (715003777) is required for installation.
- Commander X mr front bumper requires 715008218 winch electrical harness.

Can-Am HD 4500-S Winch

Commander, Commander MAX,
Maverick Trail, Maverick Sport, Maverick Sport MAX

715006417



- Ergonomic clutch handle.
- Rugged all-steel gears and bushings for more torque and durability.
- Automatic 100% load-holding brake.
- Sealed solenoid for all-weather protection.
- Weather sealed corded remote and dash mounted switch.
- Pulling strength capability of 4,500 lb (2,041 kg).
- 50' of 1/4" (15.2 m of 6.35 mm) synthetic rope.
- Corrosion-proof aluminum hawse fairlead.
- Winch Electrical Harness (715003777) is required for installation.
- Commander X mr front bumper requires 715008218 winch electrical harness.

WARN[†] VRX Winches

WARN VRX 45 Winch

Commander, Commander MAX,
Maverick Trail, Maverick Sport, Maverick Sport MAX

715006110



- Extreme IP68-rated waterproof sealing keeps the elements out.
- Durable all-metal construction.
- Black powder-coated finish and stainless steel fasteners for corrosion resistance.
- Robust new clutch design based on 70+ years of WARN 4 WD hub lock know-how.
- Load-holding brake for great control.
- Smooth and reliable all-metal three-stage planetary gear train.
- Dash-mounted rocker control.
- Limited lifetime warranty (mechanical), 3-year warranty (electrical).
- Pulling strength capability of 4,500 lb (2,041 kg).
- 50' of 1/4" (15 m of 6.3 mm) wire steel cable.
- Roller fairlead.
- Winch Electrical Harness (715003777) is required for installation.
- Commander X mr front bumper requires 715008218 winch electrical harness.

WARN VRX 45-S Winch

Commander, Commander MAX,
Maverick Trail, Maverick Sport, Maverick Sport MAX

715006111



- Extreme IP68-rated waterproof sealing keeps the elements out.
- Durable all-metal construction.
- Black powder-coated finish and stainless steel fasteners for corrosion resistance.
- Robust new clutch design based on 70+ years of WARN 4 WD hub lock know-how.
- Load-holding brake for great control.
- Smooth and reliable all-metal three-stage planetary gear train.
- Dash-mounted rocker control.
- Limited lifetime warranty (mechanical), 3-year warranty (electrical).
- Pulling strength capability of 4,500 lb (2,041 kg).
- 50' of 1/4" (15 m of 6.3 mm) synthetic rope.
- Cast aluminum hawse fairlead.
- Winch Electrical Harness (715003777) is required for installation.
- Commander X mr front bumper requires 715008218 winch electrical harness.

Winch Accessories

Can-Am HD Hawse Fairlead

Can-Am HD Winch

715006426



- A must when upgrading your winch with a synthetic cable, this corrosion-proof aluminum hawse fairlead will prevent the cable from snapping in a corner of a roller fairlead and from wearing prematurely due to the rough surface of the worn roller guide.
- Must be used with synthetic cables only.

WARN Hawse Fairlead

WARN Winch

705204567



- Double-powder-coated construction.
- Required to use the Synthetic Winch Cable (715001118) on WARN winches.
- To be used with synthetic winch cables only.

Roller Fairlead

WARN Winch

715001119

Can-Am HD Winch

715007082



- Suggested when changing the wire rope.
- Heavy-duty replacement fairlead for winches.

Wire Rope Replacement

Can-Am HD Winch

705014978



- 47' of 1/4" (14.3 m of 6.3 mm) wire rope.
- 4,500 lb (2,041 kg) pulling strength.

Synthetic Winch Cable

Can-Am HD Winch

715006430



- 50' of 1/4" (15.2 m of 6.35 mm) synthetic cable for Can-Am HD winches.
- Can-Am HD Hawse Fairlead (715006426) is required when upgrading to a synthetic cable to avoid premature cable damage and wear.

Synthetic Winch Cable

WARN winch

715001118



- 50' of 7/32" (15.2 m of 5.5 mm) synthetic cable for WARN winch.
- WARN Hawse Fairlead (705204567) is required when upgrading to a synthetic cable to avoid damage and premature wear of the cable.

Synthetic Cable Extension

Commander, Commander MAX,
Maverick Trail, Maverick Sport, Maverick Sport MAX

715001120



- Lightweight 1/4" (6.35 mm) diameter, easy to handle and won't rattle in cargo box.
- Easily attaches to winch cable to provide additional 50' (15.2 m) of distance.
- 4,500 lb (2,041 kg) single line capacity.

Winch Accessories

Wired Remote Control

Can-Am HD Winch

715006504 (2020 & up)



- This kit allows winch owners to add the hand-held remote to vehicles with a stock winch.
- OEM stock winch and Wired Remote Control are sold separately.
- EC compliant.

Wireless Remote Control

WARN Winch

715002542



- The system is quick and easy to install, thanks to a wiring harness with an integrated antenna and all necessary mounting hardware.
- Allows you to operate your winch from anywhere within a 50' (15.2 m) radius, increasing your recovery options.
- All components are weatherproof.

X rc/X mr Front Tow Hook

Commander, Commander MAX,
Maverick Trail, Maverick Sport, Maverick Sport MAX

715005229



- Offers a solid place to hook onto in case towing is needed.
- Allows you to attach most straps and hooks.
- Made of rugged 1/8" (3 mm) steel plate and 7/16" (11 mm) steel hook tube.
- Standard on Maverick X rc and X mr models.

Hitches

Front Receiver Hitch

Commander, Commander MAX,
Maverick Trail, Maverick Sport, Maverick Sport MAX

715003642



- Heavy-duty 1,500 lb (680 kg) towing capacity 2" (5 cm) receiver hitch.
- Perfect for precision towing in small spaces.

Front and Rear Hitch Drawbar

Commander, Commander MAX

715008350



- Standard on 2" (5 cm) receiver hitch.
- It offers 1,650 lb (750 kg) of towing capacity.
- Hitch ball not included.
- Forged steel.

PERFORMANCE

Smart-Lok Technology

Smart-Lok Differential

Maverick Trail, Maverick Sport, Maverick Sport MAX
(2021 & prior)

705402936



- Can-Am-exclusive Smart-Lok technology constitutes a true fully lockable on-the-fly front differential with electronically controlled automatic modes.
- Choose your differential settings according to your riding need: "2x4" for rear wheel traction only, "4x4 Front Diff. Lock" for a fully locked 4 wheel drive, and "4x4 Smart Mode" that offers preset, intelligent calibrations for your type of riding.
- Using multiple input sources, "Smart Mode" will instantaneously engage locking with the right load at the right moment to procure maximum traction while retaining low-speed maneuverability, allowing for optimal placement and a feeling of confidence.
- The Smart-Lok Differential Kit comes standard with the Trail Mode.
- Mud, Rock and Trail Activ modes can be added by installing an additional Smart Mode Module (sold separately) to fine-tune your riding environment.
- Requires Performance Half Shafts (2x) and Smart-Lok Installation Kit for installation.

Performance Half Shaft

Maverick Trail

705402423

Maverick Sport, Maverick Sport MAX

705402281



- High-performance design ideal for off-road use, with superior protection in any riding usage.
- Includes CVs, shaft and boots with the best suited geometry for your Can-Am vehicle.
- Required to install the Smart-Lok Differential Kit.

Mud Smart Mode Module

(Not illustrated)

Models with Smart-Lok Differential

715005282

- This module allows you to add the Mud Smart Mode to vehicles with the Smart-Lok Differential Kit sold as an accessory or to change to the Mud Smart Mode on vehicles equipped with a standard Smart-Lok.
- The Mud Mode has been specially designed to deliver superior traction in the deepest mud holes.
- When high engine torque and/or slippage is detected, Smart-Lok will fully lock the front end.
- The system will stay locked until throttle release.
- Only one Smart Mode Module can be installed at a time.

Rock Smart Mode Module

(Not illustrated)

Models with Smart-Lok Differential

715005283

- This module allows you to add the Rock Smart Mode to vehicles with the Smart-Lok Differential Kit sold as an accessory or to change to the Rock Smart Mode on vehicles equipped with a standard Smart-Lok.
- The Rock Mode has been specially designed to help cross challenging rocks.
- When high engine torque is detected at low vehicle speed, Smart-Lok will progressively lock the front end and will stay engaged until throttle release to prevent wheel slippage and provide optimal traction.
- The progressive engagement allows for easier steering when maneuvering the vehicle.
- Only one Smart Mode Module can be installed at a time.

Trail Activ Smart Mode Module

(Not illustrated)

Models with Smart-Lok Differential

715005284

- This module allows you to add the Trail Activ Smart Mode to vehicles with the Smart-Lok Differential Kit sold as an accessory or to change to the Trail Activ Smart Mode on vehicles equipped with a standard Smart-Lok.
- The Trail Activ Mode has been designed for aggressive riding, delivering the ultimate cornering precision.
- When high engine torque and/or an increase in vehicle speed is detected, Smart-Lok will progressively engage the front end and maintain it engaged until throttle release or vehicle speed reduction.
- The progressive engagement allows for smoother and lower steering effort.
- Only one Smart Mode Module can be installed at a time.

Exhaust and Air Intake

Yoshimura[†] Slip-On Exhaust

Maverick Sport, Maverick Sport MAX (models with 1000R engine)
Maverick Trail, Maverick Sport (except models with 700 & 1000R engine)

715004452
715003716



- Developed in collaboration with Yoshimura.
- Made from 304-grade stainless steel.
- Sporty sound from a lighter-than-stock muffler.
- USDF/USDA approved spark arrester.
- EPA compliant.
- Not EC compliant.

Performance Air Filter by Twin AIR[†]

Commander, Commander MAX, Maverick Trail, Maverick Sport, Maverick Sport MAX (models with 700 & 1000R engine)
Maverick Trail, Maverick Sport (except models with 1000R engine)

715002895
715003630



- The best choice for the harshest conditions.
- Multiple staged oiled filtering foam for superior dust retaining capacity with high airflow.
- Washable and reusable.

Engine and CVT Pre-Filter Kit

(Not illustrated)

Commander, Commander MAX, Maverick Trail, Maverick Sport, Maverick Sport MAX

715004290

- Adds extra protection to your engine and CVT in harsh riding conditions.
- Filter blocks particles larger than 0.005" (0.1 mm).
- Water repellent screen.
- Necessary to maintain the vehicle's warranty when tracks are installed.
- Recommended for winter riding conditions.
- Not compatible with Snorkel Kit.
- Not compatible with Adventure Roof Rack.

Snorkel Pre-Filter

Commander, Commander MAX, Maverick Trail, Maverick Sport, Maverick Sport MAX

715005598



- Pre-filter specifically for snorkels.
- Adds extra protection to your engine in harsh riding conditions.
- Helps keep air filter cleaner.
- Filter blocks particles larger than 0.005" (0.13 mm).
- Necessary to maintain vehicle warranty when tracks are installed.

Snorkel Kit

Commander, Commander MAX (except 700 engines), Maverick Trail (except 700 engines), Maverick Sport, Maverick Sport MAX

715003705



- Raises point of engine and CVT air intakes so vehicle can be semi-submersed in water/mud without taking in water to the engine.
- Not compatible with S&B Particle Separator, LinQ Pivoting Rack, Lonestar Racing Rear Intrusion Bar and all rear panels and windows.
- Standard on Maverick Sport and Commander X mr models.
- Not EC compliant.

Heavy-Duty Spring Kit

Maverick Trail

715004961



- This set of heavy-duty springs will stiffen your suspension.
- Perfect for reducing vehicle overall sag when shocks are under heavy demand: heavy loading and hauling or for snow clearing.
- Complete kit of 4 springs.

Shock Covers

(Not illustrated)

Maverick Sport, Maverick Sport MAX

715002368

- Soft covers for shocks with ventilation holes.
- Eliminate dust and dirt intrusion into the shock cylinder, reducing risk of damage.
- Sold in pairs.

Emergency Accessories

Emergency Kit

Commander, Commander MAX, Maverick Trail, Maverick Sport, Maverick Sport MAX

715006102



- Complete emergency kit provides all essential equipment and supplies to get out of most unfavorable situations powersport enthusiasts can find themselves in.
- Includes: Jumper Cables, Air Compressor, Tyre Repair Kit, Ratchet Tie-Down, Duct Tape, Tow Strap 3,300 lb (1,500 kg), Zip-Ties, Cloth Rags.

APACHE TRACK SYSTEMS

Winter Tracks Limited Warranty*

Apache Backcountry Track System	See table for specific models	715005247
 <ul style="list-style-type: none"> • Designed to deliver the best flotation level and deep-snow performance on the market. • Contact patch is 23% bigger than the Apache 360 LT. • Provides an impressive average ground clearance increase of 7" (18 cm), keeps the vehicle out of deep snow. 	<ul style="list-style-type: none"> • Aggressive track design with 2" (5 cm) lug height for maximum traction on snow. • Apache Backcountry Mounting Kit, Track DPS Module and Engine and CVT Pre-Filter are required. • For winter use only. • Track installation will affect vehicle width and length. 	

Apache Backcountry LT Track System	See table for specific models	715005891
 <ul style="list-style-type: none"> • Tracks designed to deliver the best snow performance on the market with unmatched flotation level and traction on snow surface. • Large contact patch, 37% bigger than the Apache 360 LT. • Impressive added ground clearance of 7" (18 cm) helps keep the vehicle over the snow. • Lightweight snowmobile-inspired rail design. 	<ul style="list-style-type: none"> • Aggressive track design with 2" (5 cm) lug height for maximum traction on snow. • Apache Backcountry LT Mounting Kit, Track DPS Module and Engine and CVT Pre-Filter are required. • Fine-tune your track system using extra Idler Wheels, Sliders with Vespel Inserts and Rail Ice Scratcher. • For winter use only. • Track installation will affect vehicle width and length. 	

Apache Backcountry Mounting Kit <i>(Not illustrated)</i>	See table for specific models Maverick Trail	715004834 715004285
<ul style="list-style-type: none"> • Required for installation of the Apache Backcountry Track System. • Not compatible with HMWPE Front and Rear A-Arm Protectors and Skid Plates. • DPS module and Pre-Filter not included. 		

Apache Backcountry LT Mounting Kit <i>(Not illustrated)</i>	See table for specific models	715005493
<ul style="list-style-type: none"> • Required for installation of the Apache Backcountry Track LT System. • DPS module and Pre-Filter are required and sold separately. • Not compatible with HMWPE Front and Rear A-Arm Protectors and Skid Plates. 		

Accessories

Track DPS Module <i>(Not illustrated)</i>	Commander, Commander MAX 2021 & up, Maverick Trail, Maverick Sport	715007338
<ul style="list-style-type: none"> • Innovative DPS module that ensures speedometer accuracy and optimized steering assist which make for perfect track control and riding ease. • Required to install the Apache and Backcountry Track Systems. 		

Rail Ice Scratchers	Apache Backcountry and Apache Backcountry LT track systems	860201728
 <ul style="list-style-type: none"> • Provide additional lubrication in hard and icy conditions. • Rail mounted, small, light. • Design expands on coil concept to allow reversing without damage. • Easily stored when not in use. • Extend slider life. 		

*The limited warranty is subject to the exclusions, limitations of liabilities and all other terms and conditions of BRP's standard limited warranty.

Apache 360 LT Track System

Commander, Commander MAX,
Maverick Trail, Maverick Sport, Maverick Sport MAX

715005103



- Multifunctional tracks designed to support heavy loads and to fit on most Can-Am off-road vehicles.
- Extra contact patch adjustment for better performance over rough terrain.
- Contact patch is 7% to 9% bigger than the Apache 360's.
- Average ground clearance of 16" (41 cm).
- 1" (2.5 cm) lugs in the front and 1.25" (3.2 cm) in the back.
- Apache 360 LT Mounting Kit, Track DPS Module and Engine and CVT Pre-Filter Kit are required.
- EC compliant.

Apache 360 LT Mounting Kit

(Not illustrated)

See table for specific models

715004755

Maverick Trail

715004833

- Required for installation of the Apache 360 LT Track System.
- DPS module and Pre-Filter not included.
- Not compatible with HMWPE Front and Rear A-Arm Protectors and Skid Plates.

Apache 360 LT Mounting Kit

(Not illustrated)

See table for specific models

715005492

- Required for installation of the Apache 360 LT Track System.
- DPS module and Pre-Filter not included.
- Not compatible with HMWPE Front and Rear A-Arm Protectors and Skid Plates.

Accessories

Idler Wheel Kit

Apache Backcountry Track System, rear tracks only

860201230 · 141 mm



- Reduces drag and rolling resistance.
- Includes 2 wheels, brackets and hardware.
- Add up to 2 kits per rear track.
- Can extend slider life in hardened snow conditions.

Apache Backcountry LT Wheel Kit

Apache Backcountry and Apache Backcountry LT Track Systems

715006293



- Additional wheel kit for Backcountry LT rear tracks.
- Reduces drag and rolling resistance in hard snow conditions or when transporting heavier loads.
- Extends slider life in hard snow conditions.
- Includes two wheels, cross shaft and mounting hardware per kit to service one track corner.
- Up to two kits per rear track can be installed.

Sliders with Vespel[†] Inserts

Apache Backcountry and Apache Backcountry LT Track Systems

503194815



- Use DuPont Vespel inserts for less friction.
- Longer life.
- Can be cut to desired length.
- 8 needed per vehicle.
- Sold individually.

*The limited warranty is subject to the exclusions, limitations of liabilities and all other terms and conditions of BRP's standard limited warranty.

APACHE TRACK SYSTEMS FITTING GUIDE

Apache Backcountry and Backcountry LT

Model Year / Model	Track	Track Mount	Track DPS Module	Prefilter without Snorkel	Prefilter with Snorkel
2018 & Up Maverick Trail	715005247	715004285	715007338	715004290 (except X mr)	715005598
2021 & Up Commander DPS & Commander XT 700 60"	715005247 (Backcountry) (doesn't fit 64")	715004834			
2019 & Up Maverick Sport, Maverick Sport MAX (except X mr, X rc, X xc models) 60"					
2021 & Up Commander, Commander MAX (except Commander DPS & Commander XT 700) 64"	715005891 (Backcountry LT) (Doesn't fit 60")	715005493			
2019 & Up Maverick Sport X mr, X rc, X xc 64"					

Apache 360 and Apache 360 LT

Model Year / Model	Track	Track Mount	Track DPS Module	Prefilter without Snorkel	Prefilter with Snorkel
2018 & Up Maverick Trail	715005103	715004833	715007338	715004290	715005598
2021 & Up Commander DPS & Commander XT 700 60"		715004755			
2019 & Up Maverick Sport, Maverick Sport MAX (except X mr, X rc, X xc models) 60"					
2021 & Up Commander, Commander MAX (except Commander DPS & Commander XT 700) 64"		715005492			
2019 & Up Maverick Sport X mr, X rc, X xc 64"					

PROMOUNT PLOWS

PROMOUNT PLOW KITS

Reference Chart

	66" Black Steel	66" Yellow Steel	72" Black Steel	72" Yellow Steel	66" Flex2	72" Flex2
Plow Kit	715007775	715008174	715007777	715008173	715007774	715007776
Blade	715006337	715006338	715004474	715006021	715006265	715004485
Push Frame	715007752	715007752	715007752	715007752	715007752	715007752
Mounting Plate	715007742	715007742	715007742	715007742	715007742	715007742

Can-Am ProMount Steel Plow Kits

Can-Am ProMount Steel 66" (168 cm) Plow Kit	Commander, Commander MAX, Maverick Trail, Maverick Sport, Maverick Sport MAX	<ul style="list-style-type: none"> ■ 715007775 · Black ■ 715008174 · Yellow
Can-Am ProMount Steel 72" (183 cm) Plow Kit	Commander, Commander MAX, Maverick Trail, Maverick Sport, Maverick Sport MAX	<ul style="list-style-type: none"> ■ 715007777 · Black ■ 715008173 · Yellow



- These kits include:
 - Can-Am ProMount Steel Blade
 - Push Frame with Quick-Attach System
 - Can-Am ProMount Mounting Plate

Can-Am ProMount Steel Blades

Can-Am ProMount Steel 66" (168 cm) Blade	Fits ProMount Push Frame	<ul style="list-style-type: none"> ■ 715006337 · Black ■ 715006338 · Yellow
	<ul style="list-style-type: none"> • Plow blade made from 12-gauge steel. • Replaceable wear blade. • Large pin designed for easy blade rotation to eliminate snow buildup at pivot point. • Blade design provides best snow roll-off at any angle. 	<ul style="list-style-type: none"> • Clears 60" (152 cm) when plow is fully angled. • Blade height of 17" (43 cm). • Compatible with Can-Am ProMount Blade accessories to further enhance plow versatility. • Not compatible with S3 High Clearance Front A-Arm.
Can-Am ProMount Steel 72" (183 cm) Blade	Fits ProMount Push Frame	<ul style="list-style-type: none"> ■ 715004474 · Black ■ 715006021 · Yellow



- Plow blade made from 12-gauge steel.
 - Replaceable wear blade.
 - Large pin designed for easy blade rotation to eliminate snow buildup at pivot point.
 - Blade design provides best snow roll-off at any angle.
- Clears 66" (168 cm) when plow is fully angled.
 - Blade height of 17" (43 cm).
 - Compatible with Can-Am ProMount Blade accessories to further enhance plow versatility.
 - Not compatible with S3 High Clearance Front A-Arm.

Can-Am ProMount Angle Plows

Can-Am ProMount 66" (168 cm) Steel Oneway State Blade	Fits ProMount Push Frame	715007263
Can-Am ProMount 72" (183 cm) Steel Oneway State Blade	Fits ProMount Push Frame	715007264



- Make the job easier with the right tools, clear long alleys and make the task easier by sending the snow further out of the way.
 - Wing end of plow measures 26" (67 cm) high and tapers down to 16" (41 cm).
- One-way "winged" state plow designed to throw snow higher.
 - Rubber Flap (715007299) designed to keep snow away from the driver is offered as accessory (sold separately).
 - Can-Am branded.

Can-Am ProMount Flex2 Plow Kit

Can-Am ProMount Flex2 66" (168 cm) Plow Kit	Commander, Commander MAX, Maverick Trail, Maverick Sport, Maverick Sport MAX	715007774
Can-Am ProMount Flex2 72" (183 cm) Plow Kit	Commander, Commander MAX, Maverick Trail, Maverick Sport, Maverick Sport MAX	715007776



- These kits include:
 - Can-Am ProMount Flex2 Blade
 - Push Frame with Quick-Attach System
 - Can-Am ProMount Mounting Plate

Can-Am ProMount Flex2 Blades

Can-Am ProMount Flex2 66" (168 cm) Blade	Fits ProMount Push Frame	715006265
	<ul style="list-style-type: none"> • Plow blade made of UHMWPE, flexible and impact absorbing material prevents damaging your plow when accidental impact occurs. • Replacable wear blade. • Large pin designed for easy blade rotation to eliminate snow buildup at pivot point. 	<ul style="list-style-type: none"> • Blade design provides best snow roll-off at any angle. • Clears 60" (152 cm) when plow is fully angled. • Blade height of 17" (43 cm). • Compatible with Can-Am ProMount Blade accessories to further enhance plow versatility.

Can-Am ProMount Flex2 72" (183 cm) Blade	Fits ProMount Push Frame	715004485
	<ul style="list-style-type: none"> • Plow blade made of UHMWPE, flexible and impact absorbing material prevents damaging your plow when accidental impact occurs. • Replaceable wear blade. • Large pin designed for easy blade rotation to eliminate snow buildup at pivot point. 	<ul style="list-style-type: none"> • Blade design provides best snow roll-off at any angle. • Clears 66" (168 cm) when plow is fully angled. • Blade height of 17" (43 cm). • Compatible with Can-Am ProMount Blade accessories to further enhance plow versatility.

Can-Am ProMount Plow Accessories

Can-Am ProMount Edge Markers	Commander, Commander MAX, Maverick Trail, Maverick Sport, Maverick Sport MAX	715004206
	<ul style="list-style-type: none"> • Help locate the edges of your plow. • Height: 24" (60 cm). • Sold in pairs. • Recommended for Maverick Trail and Maverick Sport. • Compatible with Can-Am ProMount Steel and Flex2 blades with or without Blade Extensions (except for the Can-Am ProMount Steel 54" (137 cm) Blades). 	

Can-Am ProMount 66" (168 cm) Plastic Wear Blade	Maverick Trail, Maverick Sport, Maverick Sport MAX	715004482
--	--	------------------

Can-Am ProMount 72" (183 cm) Plastic Wear Blade	Commander, Commander MAX, Maverick Trail, Maverick Sport, Maverick Sport MAX	715004483
	<ul style="list-style-type: none"> • Ideal to prevent leaving marks on your driveway. • Compatible with Can-Am ProMount 72" (183 cm) Blades. 	

Can-Am ProMount Drift Cutters	Commander, Commander MAX, Maverick Trail, Maverick Sport, Maverick Sport MAX	715006258
	<ul style="list-style-type: none"> • Help keep snow in the plow. • Dimensions: 17" x 13" (43.2 cm x 33 cm). • Sold in pairs. • Compatible with Can-Am ProMount Steel and Flex2 blades with or without Blade Extensions (except for the Can-Am ProMount Steel 54" (137 cm) Blades). 	

Can-Am ProMount Blade Extensions	Commander, Commander MAX, Maverick Trail, Maverick Sport, Maverick Sport MAX	<ul style="list-style-type: none"> ■ 715004205 · Black ■ 715005319 · Yellow
	<ul style="list-style-type: none"> • These conveniently extend your Can-Am ProMount Blade. • Add 3" (8 cm) each side. • Compatible with Can-Am ProMount Blades (except for the Can-Am ProMount Steel 54" (137 cm) Blades). • Longer Wear Blade can be installed to go over the extra length given by the extensions. 	

Back Drag Blade <i>(Not illustrated)</i>	ProMount Plows (60" and more)	715007794
	<ul style="list-style-type: none"> • ¼-in. thick steel swivel scraper. • Lifts up when the vehicle is moving forward so as not to affect the scraping. • Increased capacity to pull snow. • More aggressive scraping in reverse mode. 	<ul style="list-style-type: none"> • Lifts the scraper off the ground so that it scrapes evenly. • Adjustable in length for compatibility with 60", 66" and 72" blades. • Compatible with ProMount blades (Flex and Steel).

Curved Wear Blade

(Not illustrated)

Commander, Commander MAX,
Maverick Trail, Maverick Sport, Maverick Sport MAX,

715007792 · 66" (168 cm)

715007793 · 72" (183 cm)

- Wear blade designed with a folded back bottom lip.
- The increased surface allows for less digging while plowing uneven surfaces.
- Ideal for snow covered gravel, grass, paver stone and other soft surfaces.

Can-Am ProMount Custom Solutions

Can-Am ProMount Push Frame with Quick-Attach System

Commander, Commander MAX,
Maverick Trail, Maverick Sport, Maverick Sport MAX

715007752



- Heavy-duty steel tubes designed to withstand the roughest use.
- Mid-mount carriage provides ultimate push strength and traction.
- Allows 16" (41 cm) of plow lift on ATVs and 14" (36 cm) on Maverick Trail.
- Features a self aligning quick-attach system, an easy foot release pedal and an ergonomic handle for plow angle adjustment.

Can-Am ProMount Push Frame Extension

Commander, Commander MAX,
Maverick Trail, Maverick Sport, Maverick Sport MAX

715006257

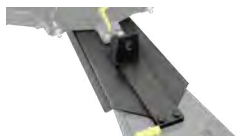

- 12" (30 cm) push frame extension required when plow is installed with Apache Track systems.

Plow Roller Fairlead

Commander, Commander MAX,
Maverick Trail, Maverick Sport, Maverick Sport MAX

715001223

• Cylindrical Roller Fairlead



- Larger diameter lower roller reduces wear on wire rope for plow application.
- Can be used with all ProMount plows.

Can-Am ProMount Plow Angling System

Commander, Commander MAX,
Maverick Trail, Maverick Sport, Maverick Sport MAX

715007801



- Converts your plow system into an easy-to-control unit from the driver's seat.
- Using one hand to control all plow motions will allow you to easily concentrate and manage your plowing tasks.
- Not compatible with Apache Backcountry LT Track System.
- Can-Am ProMount Push Frame (715007752) is required.
- Push Frame Extension 715006257 is required for installation with the Front Rancher Bumper.
- Winch and plow sold separately.

ProMount Plow Limit Switch

(Not illustrated)

Commander, Commander MAX,
Maverick Trail, Maverick Sport, Maverick Sport MAX

715006259

- For controlling the cable tension when over-raising your plow system.
- Prevents winch, plow push frame and vehicle damage.
- Sensor relocated for optimal lift height.

Can-Am ProMount Mounting Plate

Commander, Commander MAX,
Maverick Trail, Maverick Sport, Maverick Sport MAX

715007742



- Required to install the Can-Am ProMount Push Frame with Quick-Attach System.
- Mounting plate precision-designed to stay on year round without compromising ground clearance.
- Plow Roller Fairlead included.

TRAILERING

Trailer Cover



- Weather-resistant trailering cover protects your vehicle during storage and transportation.
- Heavy-duty canvas made of UV-resistant solution-dyed polyester.
- Inner soft liner protects windshield.
- All high-abrasion areas are reinforced with a double canvas layer.
- Opening for fuel cap.
- Quick and easy installation.
- Designed to perfectly fit your vehicle with or without Can-Am accessories except with Adventure Roof Rack and track kits.

Commander	715006817
Commander MAX	715007108
Maverick Trail, Maverick Sport	715003706
Maverick Sport MAX	715005281

TYRES & RIMS

Tyres – Commander

XPS Trail Force Tyre



- All-terrain radial tyre.
- 8-ply construction offered in: Front 27X9R14 & Rear 27X11R14.
- Versatile and suitable for many types of terrain.
- Aggressive tread pattern for better traction on dirt, mud and rocky terrains.
- Tread depth: 20 mm.
- Max PSI: 42.

Commander DPS

705402754 · Front
705503103 · Rear

XPS Trail King Tyre



- Radial tyre.
- 6-ply construction offered in: Front 28X9R14 & Rear 28X11R14.
- Aggressive tread pattern for tougher terrains.
- An almost continuous center tread offers a smoother trail ride.
- Tread depth: 26 mm.
- Max PSI: 42.

Commander XT

705402825 · Front
705503181 · Rear

XPS Hammer Force Tyre



- Light truck-inspired tyre.
- 8-ply construction offered in 30X10R15.
- Rock-crawling tread pattern with unique contact patch.
- Aggressive sidewall for maximum traction when faced with technical terrains.
- Tread depth: 15 mm.
- Max PSI: 44.

Commander XT-P

705402918 · Front & Rear

XPS Swamp Force Tyre



- Hybrid radial tyre for mud & trail.
- 8 Ply Rating offered in: Front 30X9R14 & Rear 30X11R14.
- Unique tread pattern allowing good grip in mud, without compromising on trail comfort.
- Tread depth: 36 mm
- Max PSI: 42

Commander X mr

705403201 · Front
705503387 · Rear

Maxxis Coronado Tyre



- Front: 27" x 9" x 14".
- Rear: 27" x 11" x 14".
- Compliant with European class T regulations.

Commander, Commander MAX†

705402058 · Front
705502576 · Rear

†Except XT-P.

Tyres - Maverick Trail & Maverick Sport

Maxxis Bighorn 2.0 Tyre

Maverick Sport, Maverick Sport MAX

705402560 · Front

705502938 · Rear



- Front · 27" x 9" x 12".
- Rear · 27" x 11" x 12".
- Compliant with European class T regulations.

Maxxis Liberty Tyre

Maverick Sport X rc

705402563 · Front

705402143 · Rear



- Engineered for performance driving and to give you and your side-by-side freedom in a variety of terrains.
- Exceeds DOT test standards.
- 8-ply radial construction.
- Specialized rubber compound for supreme traction and control.
- Excellent tread wear.
- Front: 28" x 10" x 14".
- Rear: 30" x 10" x 14".

Carlisle ACT Tyre

Maverick Trail

705402313 · Front

705402314 · Rear



- Front · 26" x 8" x 12".
- Rear · 26" x 9" x 12".

Rims

12" Maverick Trail DPS/Sport Rim

Maverick Trail DPS, Maverick Sport

Maverick Sport

Maverick Trail DPS

705401417 · Front

705501853 · Rear

705401417 · Rear



- Matching Nuts: 250100184 (Black).
- Matching Cap: 705400928.
- Maverick Sport: Front · 12" x 6" Offset = 41 mm/Rear · 12" x 7.5" Offset = 51 mm.
- Maverick Trail DPS: Front · 12" x 6" Offset = 41 mm/Rear · 12" x 6" Offset = 41 mm.

14" Maverick Sport X rc/X mr Rim

Maverick Sport X rc/X mr

Maverick Sport X rc

Maverick Sport X mr

705402338 · Front

705402338 · Rear

705502778 · Rear



- Maverick Sport X rc: Front · 14" x 7" Offset = 41 mm/Rear · 14" x 7" Offset = 41 mm.
- Maverick Sport X mr: Front · 14" x 7" Offset = 41 mm/Rear · 14" x 8.5" Offset = 51 mm.

12" Maverick Trail Rim

Maverick Trail

705401217



- Matching Nuts: 250100042.
- 12" x 6" – Offset = 41 mm.



**CAN-AM
ATVs**

CAN-AM ATVs

MODEL PACKAGES

Can-Am Outlander MAX 6x6 DPS 450	169
Can-Am Outlander MAX 6x6 DPS 450 Competitive Chart	170
Can-Am Outlander MAX 6x6 DPS 650	171
Can-Am Outlander MAX 6x6 DPS 650 Competitive Chart	172
Can-Am Renegade 110 EFI	173
Can-Am Renegade 110 EFI Competitive Chart	174

COMPARATIVE CHART

Can-Am ATV Lineup	176
-------------------	-----

ACCESSORIES

ATV Accessory Compatibility Guide	178
LinQ: Easy On, Easy Off Cargo	179
Racks & Holders	184
Cargo & Storage	185
Can-Am Windshields	187
Handlebars & Mirrors	188
Seats	189
HMWPE Skid Plates	190
Aluminum Skid Plates	191
HMWPE & Aluminum Skid Plates	193
Bumpers & Guards	194
Lights & Electrical	197
Winches	201
Hitches	203
Performance	204
Covers, Decals & Add-Ons	207
Apache Track Systems	209
ProMount Plows	212
Tyres & Rims	217



WHAT'S NEW

New Renegade 110 EFI packages replace the DS70 & DS90/90X.

Renegade 110 EFI

• For Ages 10 & up.

2023 CAN-AM OUTLANDER MAX 6X6 DPS 450



Tundra Green / 450

ENGINE	450
Type	38 hp, Rotax® 427 cc single cylinder, liquid-cooled
Fuel Delivery System	Electronic Fuel Injection (EFI)
Transmission	CVT, P/R/N/H/extra-low L, standard engine braking
Drive Train	Selectable 4WD/6WD with Visco-Lok® QE auto-locking front differential
Power Steering	Tri-Mode Dynamic Power Steering (DPS™)

SUSPENSIONS	
Front Suspension	Double A-arm 9 in. (22.9 cm) travel
Front Shocks	Oil
Rear Suspension	Double Torsional Trailing arm Independent (TTI2) with quick-release sway bar 8.8 in. (22 cm) travel
Rear Shocks	Oil

TYRES & WHEELS	
Front Tyres	Carlisle ACT HD 26 x 8 x 12 in.
Rear Tyres	Carlisle ACT HD 26 x 10 x 12 in.
Wheels	12 in. cast-aluminum

BRAKES	
Front	Dual 214 mm disc brakes with hydraulic twin-piston calipers
Rear	Single 214 mm disc brake with hydraulic twin-piston caliper

PACKAGE HIGHLIGHTS

- Unmatched uphill and downhill stability
- Incredible traction and soft ground performance
- Selectable 4WD/6WD
- Tri-Mode Dynamic Power Steering (DPS™)
- Continuously Variable Transmission (CVT) with extra low L-gear
- Double Torsional Trailing arm Independent (TTI2) rear suspension
- Quick release sway bar
- 12 in. cast-aluminum wheels
- 26 in. Carlisle® ACT HD 6-Ply tyres
- Rear bed with cargo extenders
- RF Digitally Encoded Security System (D.E.S.S.™)
- Passenger seat
- Extended wheelbase
- Raised floorboards

DIMENSIONS & CAPACITIES

Estimated Dry Weight	1,000 lb (454 kg)
L x W x H	118 x 46 x 57 in. (300 x 117 x 145 cm)
Wheelbase	90 in. (228.5 cm)
Ground Clearance	10.5 in. (26.7 cm)
Seat Height	33.8 in. (85.8 cm)
Rack Capacity	Front: 120 lb (54.4 kg)/Rear: 350 lb (159 kg)
Storage Capacity	2.9 gal (10.9 L)
Towing Capacity	1,650 lb (750 kg)
Fuel Capacity	5.4 gal (20.5 L)
Person Capacity	2

FEATURES

Gauge	4.5 in. digital display
Instrumentation	DC outlet, 15-A connector
Ignition	RF Digitally Encoded Security System (D.E.S.S.™)
Lighting	70 W headlights
Winch	Prewired for available winch
Seat	Convertible Rack System (CRS)
Handlebar	Standard
Protection	Central Skid Plate

WARRANTY & EXTENDED SERVICE

Factory Warranty	2 years / 15,000 km, whichever comes first
Service Intervals	100 hours / 12 months / 3000 km



		Can-Am Outlander Max 6X6 DPS 450	Polaris Ranger 500	Honda Pioneer 520
Engine Size (cc)		427 cc	500 cc	518 cc
No. of Cylinders	=	1	1	1
Horsepower	+	38 hp	32 hp	Not listed
Transmission	=	CVT with extra low L-range	Automatic PVT; shaft	5 speed with reverse; manual and automatic modes
Traction Options	+	4WD or 6WD selectable (ultimate traction)	On Demand True AWD/2WD/Versatrac turf mode	2WD or 4WD
Power Steering	+	Tri-Mode Adjustable Dynamic Power Steering (DPS)	No	No
Front Suspension	=	Double A-arm	MacPherson Strut	Independent Double-Wishbone
Rear Suspension		DoubleTorsional trailing arm Independent (TTI2) with quick release sway bar	Dual A-arm IRS	Independent Double-Wishbone
Wheel Size	=	12"	12"	12"
Wheel Material	+	Aluminium	Steel	Steel
Tyre Diameter	+	26"	25"	24"
Tyre Ply Rating	=	6 ply	6 ply	4 ply
Towing Capacity	+	750 kg	680 kg	454 kg
Total Cargo Capacity		213 kg	226.8 kg	204 kg
Ground Clearance	+	27 cm	25 cm	22 cm
Overall Length	+	300 cm	279 cm	267 cm
Overall Width	+	117 cm	147 cm	127 cm
In-Line Vineyard Ready Seating	+	Yes	No	No
Vehicle Dry Weight	=	454 kg	483 kg	482 kg - Kerb
Fuel Capacity		20.5 L	34 L	15.4 L
Speed Limiting Device	+	Programmable speed limiting safety key	No	No
Anti Theft Device	+	DESS security key system	No	No
Warranty Period		2 years/15,000 km, whichever comes first	1 year unlimited km	3 years unlimited km
Seating Capacity	=	2	2	2
Display	=	4.5" Digital Display	2" LCD	Analog speedo with LCD insert

2023 CAN-AM OUTLANDER MAX 6X6 DPS 650



Tundra Green / 650

ENGINE	650
Type	62 hp, Rotax® 650 cc, V-twin, liquid-cooled
Fuel Delivery System	Electronic Fuel Injection (EFI)
Transmission	CVT, P/R/N/H/extra-low L, standard engine braking
Drive Train	Selectable 4WD/6WD with Visco-Lok ¹ QE auto-locking front differential
Power Steering	Tri-Mode Dynamic Power Steering (DPS™)

SUSPENSIONS	
Front Suspension	Arched double A-arm with front sway bar 9.2 in. (23.3 cm) travel
Front Shocks	Oil
Rear Suspension	Double Torsional Trailing arm Independent (TTI2) with quick-release sway bar 9.9 in. (25.1 cm) travel
Rear Shocks	Oil

TYRES & WHEELS	
Front Tyres	ITP Terracross 26 x 8 x 14 in.
Rear Tyres	ITP Terracross 26 x 10 x 14 in.
Wheels	14 in. cast-aluminum

BRAKES	
Front	Dual 214 mm disc brakes with hydraulic twin-piston calipers
Rear	Dual 214 mm disc brakes with hydraulic twin-piston calipers

PACKAGE HIGHLIGHTS

- Unmatched uphill and downhill stability
- Incredible traction and soft ground performance
- Towing and cargo carrying capability to rival most mid sized SSVs
- Selectable 4WD/6WD
- Tri-Mode Dynamic Power Steering (DPS™)
- Continuously Variable Transmission (CVT) with extra low L-gear
- Visco-Lok¹ QE auto-locking front differential
- Double Torsional Trailing arm Independent (TTI2) rear suspension
- Quick release rear sway bar
- 14 in. cast-aluminum wheels
- 26 in. ITP Terracross¹ radial tyres
- Dump dual-level cargo box with modular accessories
- 2 person capability, with removable passenger seat

DIMENSIONS & CAPACITIES

Estimated Dry Weight	1,100 lb (499 kg)
L x W x H	124.8 x 48.5 x 55.3 in. (317 x 123 x 140 cm)
Wheelbase	90 in. (228.5 cm)
Ground Clearance	11 in. (27.9 cm)
Seat Height	34.5 in. (87.7 cm)
Rack Capacity	Front: 100 lb (45 kg)/Rear: 700 lb (318 kg)
Storage Capacity	Dual-level cargo box with sidewalls and tailgate 18.5 gal (70 L)
Towing Capacity	1,650 lb (750 kg)
Fuel Capacity	5.4 gal (20.5 L)
Person Capacity	2

FEATURES

Gauge	4.5 in. digital display
Instrumentation	DC outlet, 15-A connector
Ignition	RF Digitally Encoded Security System (D.E.S.S.™)
Lighting	LED headlights
Winch	Prewired for available winch
Seat	Convertible Rack System (CRS)
Handlebar	Standard
Protection	Central Skid Plate

WARRANTY & EXTENDED SERVICE

Factory Warranty	2 years / 15,000 km, whichever comes first
Service Intervals	100 hours / 12 months / 3000 km



		Can-Am Outlander Max 6X6 DPS 650	Polaris Ranger 570 HD EPS (ADC)	Honda Pioneer 700-2
Engine Size (cc)		650 cc	567 cc	675 cc
No. of Cylinders	+	2	1	1
Horsepower	+	62 hp	44 hp	36.1 hp
Transmission	=	CVT with extra low L-range	Automatic PVT; shaft	3 speed with reverse; manual and automatic modes
Traction Options	+	4WD or 6WD selectable (ultimate traction)	On Demand True AWD/2WD/Versatrac turf mode	2WD, 4WD, 4WD Lock
Power Steering	+	Tri-Mode Adjustable Dynamic Power Steering (DPS)	Electronic Power Steering	Electric Power Steering
Front Suspension	+	Arched double A-arm with front sway bar	MacPherson Strut	Independent Double-wishbone
Rear Suspension	+	Double Torsional Trailing arm Independent (TTI2) with quick release sway bar	Dual A-arm IRS	Independent Double-wishbone
Wheel Size	+	14"	12"	12"
Wheel Material	=	Aluminium	Aluminium	Steel
Tyre Diameter	+	26"	25"	25"
Tyre Ply Rating	=	6 ply	6 ply	4 ply
Towing Capacity	+	750 kg	680.4 kg	680 kg
Total Cargo Capacity		363 kg	453.6 kg	408 kg
Ground Clearance	+	27.9 cm	25.4 cm	27 cm
Overall Length	+	317 cm	279 cm	291 cm
Overall Width	+	123 cm	147 cm	152.5 cm
Vehicle Dry Weight	=	499 kg	499 kg	583 kg - Kerb
Fuel Capacity		20.5 L	34.1 L	30 L
Speed Limiting Device	+	Programmable speed limiting safety key	Drivers seatbelt limiter 25kph	Drivers seatbelt limiter 25kph
Anti Theft Device	+	DESS security key system	No	No
Warranty Period		2 years/15,000 km, whichever comes first	1 year unlimited km	3 years unlimited km
In-Line Vineyard Ready Seating	+	Yes	No	No
Seating Capacity	+	2	2	2
Display	+	4.5" Digital Display	2" LCD	Analog speedo with LCD insert

2023 CAN-AM RENEGADE 110 EFI



 Catalyst Gray & Neo Yellow / 110 EFI

PACKAGE HIGHLIGHTS

- For ages 10 and up
- Heavy duty design capable of 100+ kg riders
- 4-stroke engine with Electronic Fuel Injection (EFI)
- Fully automatic continuously variable transmission (CVT)
- Independent A-arm front suspension
- Electric start
- Built-in throttle limiter

ENGINE	110 EFI
Type	112 cc 4-stroke single cylinder, air cooled
Fuel Delivery System	Electronic Fuel Injection (EFI) with built-in throttle limiter
Transmission	CVT, F/N/R
Drive Train	Chain driven/2WD Electric starting system
Power Steering	N/A

SUSPENSIONS	
Front Suspension	Single A-arm 5 in. (12.7 cm) travel
Front Shocks	Oil
Rear Suspension	Swingarm 6 in. (15.2 cm) travel
Rear Shocks	Oil

TYRES & WHEELS	
Front Tyres	19 x 7 x 8 in.
Rear Tyres	18 x 9.5 x 8 in.
Wheels	8 in. steel

BRAKES	
Front	Dual drum brakes
Rear	Single drum brakes

DIMENSIONS & CAPACITIES	
Estimated Dry Weight	295 lb (134 kg)
L x W x H	60.6 x 40.4 x 38.6 in. (154 x 103 x 98 cm)
Wheelbase	41 in (105 cm)
Ground Clearance	8.3 in. (21.1 cm) under frame/ 4.5 in. (11.4 cm) under rear axle
Seat Height	28 in. (71 cm)
Rack Capacity	N/A
Storage Capacity	N/A
Towing Capacity	N/A
Fuel Capacity	1.6 gal (6 L)
Person Capacity	1

FEATURES	
Gauge	Neutral, reverse, fuel level, & check engine lights
Instrumentation	N/A
Lighting	Halogen running headlights
Winch	N/A
Seat	Standard
Handlebar	Ergonomics & controls for ages 10 years and up
Protection	Front bumper

WARRANTY & EXTENDED SERVICE	
Factory Warranty	6 months limited
Service Intervals	30 hours / 12 months / 500 km





**Can-Am
Renegade 110 EFI**

**Yamaha
YFM90R - 2023**

		Can-Am Renegade 110 EFI	Yamaha YFM90R - 2023
Engine Size (cc)	+	112 cc	89.9 cc
No. of Cylinders	=	1	1
Transmission	=	CVT (no gears)	CVT (no gears)
Front Suspension		Single A-arm	Single A-arm
Rear Suspension	=	Swingarm	Swingarm
Wheel Size		8"	8"
Wheel Material	=	Steel	Steel
Tyre Size	=	19"/18"	18"
Ground Clearance		21.1 cm under frame / 11.4 cm under rear axle	10 cm
Overall Length	+	154 cm	148.5 cm
Overall Width	+	103 cm	102 cm
Fuel Capacity		6 L	6.6 L
Fuel Delivery System	=	Electronic Fuel Injection	Carburetor
Seat Height		71 cm	75 cm
Starter		Electric	Electric with backup kickstart
Overall Weight		Dry 134 kg	Wet 126.5 kg
Ages		10 and up	10 and up
Maximum Rider Weight	+	102 kg	82 kg

	Suzuki Quadsport Z90	Kawasaki KFX 90	CFMoto Cforce 110
	80 cc	90 cc	110 cc
	1	1	1
	CVT (no gears)	CVT (no gears)	CVT (no gears)
	Single A-arm	Single A-arm	Independent double A-arm
	Swingarm	Swingarm	Mono mid-placed shock absorber
	8"	8"	10" / 8"
	Steel	Steel	Steel
	19"	18"	19" / 18"
	15 cm	10 cm	11 cm
	150.5 cm	142.5 cm	149 cm
	87.5 cm	90.5 cm	95 cm
	6 L	5.3 L	6.4 L
	Carburetor	Carburetor	Electronic Fuel Injection
	65 cm	65 cm	69 cm
	Electric with backup recoil	Electric with kick backup	Electric
	Dry 127 kg	Dry 122 kg	Wet 125 kg
	12 and up	12 and up	6 to 12
	90 kg	85 kg	Not listed

		OUTLANDER MAX 6x6 DPS		RENEGADE 110 EFI
				
COLOUR OPTIONS		Tundra Green		Catalyst Gray & Neo Yellow
ENGINES	Type	450	650	110 EFI
		38 hp, Rotax® 427 cc single cylinder, liquid-cooled		62 hp, Rotax® 650 cc, V-twin, liquid-cooled
	Fuel Delivery System	Electronic Fuel Injection (EFI)		Electronic Fuel Injection (EFI) with built-in throttle limiter
	Transmission	CVT, P/R/N/H/extra-low L, standard engine braking		CVT, F/N/R
	Drive Train	Selectable 4WD/6WD with Visco-Lok [†] QE auto-locking front differential		Chain driven/2WD electric starting system
	Power Steering	Tri-Mode Dynamic Power Steering (DPS™)		N/A
SUSPENSIONS	Front Suspension	Double A-arm 9 in. (22.9 cm) travel	Arched double A-arm with front sway bar 9.2 in. (23.3 cm) travel	Single A-arm 5 in. (12.7 cm) travel
	Front Shocks	Oil		
	Rear Suspension	Double Torsional Trailing arm Independent (TTI2) with quick-release sway bar 8.8 in. (22 cm) travel	Double Torsional Trailing arm Independent (TTI2) with quick-release sway bar 9.9 in. (25.1 cm) travel	Swingarm 6 in. (15.2 cm) travel
	Rear Shocks	Oil		
TYRES/WHEELS	Front Tyres	Carlisle [†] ACT HD 26 x 8 x 12 in.	ITP Terracross [†] 26 x 8 x 14 in.	19 x 7 x 8 in.
	Rear Tyres Wheels	Carlisle [†] ACT HD 26 x 10 x 12 in. 12 in. cast-aluminum	ITP Terracross [†] 26 x 10 x 14 in. 14 in. cast-aluminum	18 x 9.5 x 8 in. 8 in. steel
BRAKES	Front	Dual 214 mm disc brakes with hydraulic twin-piston calipers		Dual drum brakes
	Rear	Single 214 mm disc brake with hydraulic twin-piston caliper	Dual 214 mm disc brakes with hydraulic twin-piston calipers	Single drum brake
DIMENSIONS/CAPACITIES	Estimated Dry Weight	1,000 lb (454 kg)	1,100 lb (499 kg)	295 lb (134 kg)
	L x W x H	118 x 46 x 57 in. (300 x 117 x 145 cm)	124.8 x 48.5 x 55.3 in. (317 x 123 x 140 cm)	60.6 x 40.4 x 38.6 in. (154 x 103 x 98 cm)
	Wheelbase	90 in. (228.5 cm)		41 in (105 cm)
	Ground Clearance	10.5 in. (26.7 cm)	11 in. (27.9 cm)	8.3 in. (21.1 cm) under frame/ 4.5 in. (11.4 cm) under rear axle
	Seat Height	33.8 in. (85.8 cm)	34.5 in. (87.7 cm)	28 in. (71 cm)
	Rack Capacity	Front: 100 lb (45 kg)/Rear: 200 lb (90 kg)	Front: 100 lb (45 kg)/Rear: 700 lb (318 kg)	N/A
	Storage Capacity	2.9 gal (10.9 L)	Dual-level cargo box with sidewalls and tailgate 18.5 gal (70 L)	N/A
	Towing Capacity	1,650 lb (750 kg)		N/A
	Fuel Capacity	5.4 gal (20.5 L)		1.6 gal (6 L)
FEATURES	Gauge	4.5 in. digital display		Neutral, reverse, fuel level & check engine lights
	Instrumentation	DC outlet, 15-A connector		N/A
	Ignition	Ignition - RF Digitally Encoded Security System (D.E.S.S.™)		Key
	Lighting	70 W headlights	LED headlights	Halogen running headlights
	Winch	Prewired for available winch		N/A
	Seat	Convertible Rack System (CRS)		Standard
	Handlebar	Standard		Ergonomy & controls for 10 years old and up
	Protection	Central Skid Plate		Front bumper

[†] Visco-Lok is a trademark of GKN Viscodrive GmbH.



ACCESSORIES

ATVs

ATV ACCESSORY COMPATIBILITY GUIDE

We've made things super simple.

- Check your model year
- Choose engine and model
- Learn your **PLATFORM CODE**

This **PLATFORM CODE** will let you know at a glance if the accessory is compatible with your vehicle.

Model year	Model	Engine configuration	Platform code
2015	Outlander L	450, 500	G2L
	Outlander	500, 650, 800, 1000	G2
	Outlander L MAX	450, 500	G2L
	Outlander MAX	500, 650, 800, 1000	G2
	6x6	650, 1000	G2
	Renegade	500, 800, 1000	G2S
2016	Outlander L	450, 570	G2L
	Outlander	570, 650, 850, 1000	G2
	Outlander L MAX	450, 570	G2L
	Outlander MAX	570, 650, 850, 1000	G2
	6x6	650, 1000	G2
	Renegade	570, 850, 1000	G2S
2017	Outlander	450, 570	G2L
	Outlander	650, 850, 1000	G2
2018	Outlander MAX	450, 570	G2L
	Outlander MAX	650, 850, 1000	G2
	6x6	650, 1000	G2
	Renegade	570, 850, 1000	G2S
2019	Outlander	450, 570	G2L
2020	Outlander	650, 850, 1000R	G2
2021	Outlander MAX	450, 570	G2L
2022	Outlander MAX	650, 850, 1000R	G2
2023	6x6	450	G2L
	6x6	650, 1000	G2
	Renegade	570, 650, 850, 1000R	G2S



LINQ: EASY ON, EASY OFF CARGO

LINQ ACCESSORIES

Compatibility/requirements

<ul style="list-style-type: none"> No tools needed: Quickly install and remove accessories by hand. Equip your Can-Am for specialized tasks in no time. Sturdy mounting system that holds up to the roughest terrain. 	OUTLANDER 450/570	OUTLANDER	RENEGADE
LinQ Accessories with 16" Base <ul style="list-style-type: none"> LinQ anchors mounted 16 inches apart, center-to-center. Lower loading capacity than the LinQ with 36" base accessories. Can be used on Can-Am ATV and SSV vehicles, Can-Am Spyder and Ryker vehicles, Sea-Doo watercraft and Ski-Doo snowmobiles. 			
LinQ 4.2 Gal (16 L) Cooler 219400964 • Black / 295100698 • White	LinQ Adapter Plate 715007273 & LinQ Base Installation Kit 715008125	LinQ Anchor Adapter Kit 715004960	LinQ Luggage Rack 715001734 & LinQ Anchor Adapter Kit 715004960 OR LinQ Adapter Plate 715007274 & LinQ Base Installation Kit 715008125
LinQ Tool Box 715008111			
LinQ SR 5.5 Gal (21 L) Bag 860202449			
LinQ 4.5 Gal (17 L) Sport Bag 860202447			
LinQ Modular Box 715005494 • (10 L) 715007112 • (20 L) 715006830 • (30 L)			
LinQ Tool Kit 715006829			
LinQ Roll-Top Bag 715008110			
LinQ Accessories with 36" Base <ul style="list-style-type: none"> Mount on LinQ racks often used by Can-Am ORV vehicles. Higher loading capacity than the LinQ with 16" base accessories. Usage is limited to Can-Am ORV vehicles. 			
LinQ 12 Gal (45 L) Cargo Box 715003879	LinQ Base 715002350	No further requirements	LinQ Luggage Rack 715001734
LinQ 23 Gal (86 L) Trunk Box 715004923	No compatibility		
LinQ 32 Gal (121 L) Trunk Box 715001747 (2-up) 715001749 (MAX)	No compatibility		
LinQ 11.5 Gal (43 L) Audio Cargo Box 715003018	LinQ Base 715002350		
LinQ 8 Gal (30 L) Cooler Box 715004778 • Black / 715004698 • Gray	No compatibility		
LinQ Premium Storage Bag by OGIO 715002923 • Black	LinQ Base 715002350		
LinQ Heavy Duty Basket 715001215			
LinQ Low Profile Basket 715004282			
LinQ Holders			
LinQ 4" Rack 715001711 • Silver / 715001665 • Black	Not compatible <i>*Alternative 5" or 8" Rack Extensions (715001913 or 715001914) are available for G2L</i>	No further requirements	LinQ Luggage Rack 715001734
LinQ 6" (15 cm) Rack Extension 715001712 • Silver / 715001671 • Black			
LinQ Mounted Gear Grips 715005340	LinQ Base 715002350		
LinQ Tool Holder 715007358			
LinQ Gun Boot Rack 715002112 715002113	Not compatible <i>*Alternative Gun Boot Racks (715001918 or 715001919) are available for G2L</i>	No compatibility	No compatibility

LinQ Accessories with 16" base

LinQ Modular Box	G2, G2L, G2S	715005494 · (10 L) 715007112 · (20 L) 715006830 · (30 L)
	<ul style="list-style-type: none"> ▪ Allows stacking of other modular boxes to always have the right gear accessible. ▪ Always have the right box size to fit everything. ▪ Can be installed on any LinQ base with a 16" width. ▪ See table for installation location and requirements. 	
Thermal Insert For LinQ Modular Box (10 L)	G2, G2L, G2S	219401110
	<ul style="list-style-type: none"> ▪ Insulated liner. ▪ Fits very well in the LinQ Modular Box (10 L). ▪ Can contain five 473 ml cans or six 355 ml cans. 	
LinQ Tool Kit	G2, G2L, G2S	715006829
	<ul style="list-style-type: none"> ▪ Includes: <ul style="list-style-type: none"> - Cutter pliers - Long-nose pliers - Locking plier - Ratchet wrench 3/8" drive - 6" ratchet extension - Integrated CVT belt storage location (belt not included) - Long-socket 19 mm 3/8" drive - 6pts - Long-socket 17 mm 3/8" drive - 6pts - Socket 18 mm 3/8" drive - Socket 15 mm 3/8" drive - Socket 13 mm 3/8" drive - Socket 10 mm 3/8" drive - Socket 8 mm 3/8" drive - Combined wrench 19 mm - Combined wrench 18 mm - Combined wrench 15 mm - Combined wrench 13 mm - Combined wrench 10 mm - Combined wrench 8 mm - Socket Torx T40 3/8" drive - Socket Torx T30 3/8" drive - Socket Torx T20 3/8" drive - Breaker bar 3/8" drive ▪ See table for installation location and requirements. 	
LinQ 4.2 Gal (16 L) Cooler	G2, G2L, G2S	■ 219400964 · Black ■ 295100698 · Gray
	<ul style="list-style-type: none"> ▪ All the benefits of LinQ—simple, fast and secure. ▪ Rotomolded construction for exceptional rigidity and durability. ▪ Premium-quality foam insulation for optimal ice retention. ▪ Uses LinQ mounting system (Patent US 8777531 and US 8875830). ▪ Easy one-second on/off tool-less system. ▪ See table for installation location and requirements. 	
LinQ Tool Box	G2, G2L, G2S	715008111
	<ul style="list-style-type: none"> ▪ High precision injected HDPE construction provides rigidity and durability. ▪ 5 gal (19 L) maximum capacity. ▪ Weather-resistant, sealed and lockable cover. ▪ Marinized for salt water purposes. ▪ See table for installation location and requirements. 	
LinQ Roll-Top Bag	G2, G2L, G2S	715008110
	<ul style="list-style-type: none"> ▪ Fully waterproof Roll-Top dry bag will securely store and confine your equipment. ▪ LinQ mounted using heavy-duty rigid plastic base. ▪ High capacity storage solution 10.6 gal (40 L). ▪ Bottom foam liner for additional equipment protection. ▪ Integrated handle for easy transportation on/off the vehicle. ▪ Marinized for salt water purposes. ▪ See table for installation location and requirements. 	

SR 5.5 Gal (21 L) LinQ Bag	G2, G2L, G2S	860202449
	<ul style="list-style-type: none"> • Semi-rigid expandable bag. • 5.5 gal (21 L) capacity. • See table for installation location and requirements. 	

LinQ 4.5 Gal (17 L) Sport Bag	G2, G2L, G2S	860202447
	<ul style="list-style-type: none"> • 4.5 gal (17 L) capacity. • Rigid bottom, semi-rigid top. • See table for installation location and requirements. 	

LinQ Accessories with 36" base

LinQ 12 Gal (45 L) Cargo Box	G2 (front only for 6x6 & MAX models 2013-2014), G2L, G2S	715003879
	<ul style="list-style-type: none"> • LinQ mounted for easy on, easy off installation. • Holds cargo safely and securely while riding. • See table for installation location and requirements. 	

LinQ 23 Gal (86 L) Trunk Box	G2 (except 6x6 models), G2L, G2S	715004923
	<ul style="list-style-type: none"> • LinQ mounted for easy on, easy off installation. • Lockable and weather-resistant. • Holds cargo safely and securely while riding. • Comfort pads for passenger. • See table for installation location and requirements. 	

LinQ 32 Gal (121 L) Trunk Box	G2 (except MAX models & 6x6), G2S European Version (EC compliant)	715001747 715001748 · No rear tail light.
	<ul style="list-style-type: none"> • LinQ Retrofit Adapter Plate (715001334) is required for G1 models. • Trunk Box Panels available in many colours to match your vehicle (sold separately). • See table for installation location and requirements. 	

LinQ 32 Gal (121 L) Trunk Box for Outlander Max	G2 (MAX models only except 6x6 models) European Version (EC compliant)	715001749 715001750 · No rear tail light.
	<ul style="list-style-type: none"> • Passenger comfort is ensured on active rides as well as longer recreational rides thanks to the ergonomically designed passenger padding comfort-fitted with a portion made of closed cell foam that won't absorb water. • Very easy to embark even when driver is seated. • Trunk Box Panels available in many colours to match your vehicle (sold separately). 	

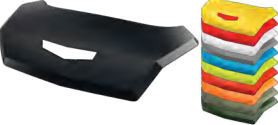
LinQ 32 Gal (121 L) Trunk Box Panels	G2 (except 6x6 models), G2S	
	<ul style="list-style-type: none"> • Colour panels to match the LinQ 32 gal (121 L) Trunk Box to your vehicle. 	<ul style="list-style-type: none"> ■ 715001391 · Black ■ 715001392 · Yellow ■ 715001395 · Viper Red □ 715002481 · White ■ 715002480 · Light Gray ■ 715002984 · Octane Blue ■ 715002985 · Manta Green ■ 715002986 · Can-Am Red ■ 715006119 · Orange Crush ■ 715006120 · Squadron Green ■ 715007074 · Tundra Green

LinQ 32 Gal (121 L) Trunk Box Panels
(Not illustrated)

EUROPEAN VERSION (EC compliant)

- Colour panels to match the LinQ 32 gal (121 L) Trunk Box to your vehicle.
- No rear tail light.

- **715001397** · Black
 - **715001398** · Yellow
 - **715006124** · Viper Red
 - **715002483** · White
- **715006122** · Manta Green
 - **715006121** · Can-Am Red
 - **715006123** · Orange Crush

LinQ 11.5 Gal (43 L) Audio Cargo Box

G2 (front only for 6x6 & MAX models 2013-2014), G2L, G2S

715003018



- Mounts on/off easily to hold/carry cargo safely and securely.
- The Bluetooth enabled receiver and 6.5" (16.5 cm) speakers are smartly concealed and integrated in the cover.
- Automatic shut-off function protects your battery by turning the system off after 10 minutes of inactivity.
- Backlit control panel perfect for night riding.
- Water-resistant speakers.
- Delivers the best sound quality on the market to sweeten your ride courtesy of a built-in full range high-efficiency amplifier.
- See table for installation location and requirements.

LinQ 8 Gal (30 L) Cooler Box

G2 (except 6x6 models), G2S

- **715004778** · Black
- **715004698** · Gray



- LinQ mounted for easy on, easy off installation.
- Rotomolded construction provides exceptional rigidity and durability.
- Premium-quality foam insulation for optimal ice retention.
- Integrated, fully-removable compartment protects food.
- Robust rubber latches keep the cover tightly closed.
- Weather-resistant.
- Convenient drain plug.
- See table for installation location and requirements.

LinQ Premium Storage Bag by OGIO

G2 (except 6x6 models), G2L, G2S

■ **715002923** · Black



- LinQ mounted for easy on, easy off installation.
- Holds cargo safely and securely while riding.
- See table for installation location and requirements.

LinQ Low Profile Basket

G2, G2L (front only for MAX & 6x6 models), G2S

715004282



- Low profile, open basket increases cargo space.
- Perfect for easy access to tools, rope, winch and plow accessories.
- Multiple bungee cord and tie-down anchor points.
- Made of impact-resistant injected polypropylene.
- See table for installation location and requirements.

LinQ Heavy-Duty Basket

G2, G2L (front only for MAX & 6x6 models), G2S

715001215



- Made of high-strength, low-alloy steel.
- LinQ mount for easy on, easy off installation.
- Can be placed on both front and back racks of vehicle.
- See table for installation location and requirements.

Large Cargo Box

G2, G2L (except 6x6)

715007001



- Rear bed to carry large items.
- Anchor points (D-ring), LinQ fixtures for tool holder, and marks to allow the installation of a 16" accessory.
- Also has a mat for the floor and slot to enable the installation of a divider and a slot for a divider to close the recess on the rear vertical lip.
- It is installed on ATV platforms through the LinQ system and hooks to make it easily installable and removable.

LinQ Holders

LinQ Tool Holder

G2, G2S, G2L

715007358



- Ultra-versatile tool holder.
- Convenient swivel-latch allows tools to be stored in any orientation.
- Sold in pairs.

LinQ Gear Grips

G2, G2S, G2L

715005340



- Durable and flexible grips provide a custom fit for a variety of items from 1" to 4" (2.5 cm to 10 cm) in diameter.
- Heavy-duty design for carrying bows, fishing poles, rakes, farm tools and more.
- Quick-release button opens grip quickly for easy access to gear.
- Heavy-duty base system built for the toughest adventures.
- Make transporting your tools a snap by combining the Gear Grips with the LinQ System.
- 360° orientation.
- Sold in pairs.

LinQ Mounting

LinQ Anchor Adapter Kit

G2, G2S

715004960



- Allows the installation of accessories with LinQ base of 16" on LinQ racks.
- Tool-less installation and removal.
- For G2S, the LinQ Luggage Rack (715001734) is required for installation.

LinQ Base

G2L

715002350



- Made of polypropylene glass fiber.
- Allows you to install LinQ accessories.
- Sold in pack of 4.

LinQ Lock

G2, G2S, G2L,

860201968



- Simple way to securely lock most LinQ accessories.
- Lock cover protects lock from the elements.
- Corrosion resistant.
- Pack of 1, includes 2 keys.
- Not compatible with LinQ 4.2 US gal (16 L) Cooler, LinQ Tool Box, LinQ Tool Holder and LinQ Gear Grips.

LinQ Replacement Parts

715001707



- Unique mounting fastener usable on any LinQ System accessory.
- Tool-less installation and removal.
- Sold in pairs.

RACKS & HOLDERS

LinQ Rack Extension – 4" (10 cm)	G2, G2S	■ 715001711 · Silver ■ 715001665 · Black
---	---------	--



- Fits front or rear.
- Strong and durable.
- Helps keep cargo securely in place.
- Easy and tool-less installation thanks to the LinQ System.
- Anti-corrosion coating with durable powder coat finish.
- LinQ Luggage Rack (715001734) is required for G2S.

LinQ Rack Extension – 6" (15 cm)	G2, G2S	■ 715001712 · Silver ■ 715001671 · Black
---	---------	--



- Fits front or rear.
- Strong and durable.
- Helps keep cargo securely in place.
- Easy and tool-less installation thanks to the LinQ System.
- Anti-corrosion coating with durable powder coat finish.
- LinQ Luggage Rack (715001734) is required for G2S.

Rack Extension – 5" (13 cm)	G2L	715001913
------------------------------------	-----	------------------



- Fits front or rear.
- Made of carbon steel.
- Provides tie-down points to secure cargo on racks.
- Easy installation on tubular rack.
- Anti-corrosion coating with durable powder coat finish.

Rack Extension – 8" (20 cm)	G2L	715001914
------------------------------------	-----	------------------



- Fits front or rear.
- Made of carbon steel.
- Provides tie-down points to secure cargo on racks.
- Easy installation on tubular rack.
- Anti-corrosion coating with durable powder coat finish.

LinQ Luggage Rack	G2S (except X mr models)	715001734
--------------------------	--------------------------	------------------



- Bolt-on rack.
- Enables use of LinQ mounted accessories on the G2S.

LinQ Base Plate	G2L	715007273
------------------------	-----	------------------



- Enables use of 16" wide LinQ base accessories on G2L to extend cargo options and journey opportunities.
- Requires LinQ base kit (715008125).

LinQ Base Plate	G2S	715007274
------------------------	-----	------------------



- Enables use of 16" wide LinQ base accessories on G2S to extend cargo options and journey opportunities.
- Requires LinQ Base Kit (715008125).

Gun Boot Rack	G2L (except MAX models)	715001918
	G2L (MAX models only)	715001919



- Made of steel.
- Designed for the tubular rack.
- For use with Gun Boot 6.0 Impact by Kolpin.
- Can be mounted to either side of the vehicle.

Gun Boot 6.0 Impact[†] By Kolpin[†]	G2, G2L	715001419
--	---------	------------------



- Extra room for pistol-grip-type weapons and small bipods.
- Easily fits firearms up to 51" (130 cm) in total length.
- Provides ample room for 2 3/8" (60 mm) scopes.
- Hatchback design allows easy access.
- Ergonomically designed handle and molded attachment points for sling.
- Snap-close cover with locking capability.
- Designed to accommodate left and right hand bolt-action rifles and shotguns.
- Includes removable, shock absorbing foam and nylon Impact liner for superior interior protection.
- Requires appropriate mounting kit for installation.

LinQ Gun Boot Rack <i>(Not illustrated)</i>	G2 (except MAX, 6x6 & X mr 1000)	715002112
	G2 (MAX & X mr 1000 models only)	715002113

- This lightweight Gun Boot Rack can be mounted on either side of your Outlander using the tool-less LinQ System.
- For use with Gun Boot 6.0 Impact by Kolpin.

Multi-Fit Holder	G2, G2L	715002354 · Single
		715001945 · Double



- Open U-shaped bracket for carrying tools (shovel, axe) and hunting weapons (rifle, bow) that are safely secured, but easily accessible.
- Easy installation on tubular rack, extension racks, basket or bumpers.
- For G2, the LinQ Rack Extension (715001711) is required.
- Sold in pairs.

LinQ Gear Grips	G2L	715001421
------------------------	-----	------------------



- Durable, flexible grips cushion and protect while providing a custom fit for a variety of items from 1" to 4" (2.5 cm to 10 cm) in diameter.
- Heavy-duty design for carrying bows, fishing poles, rakes, farm tools and more.
- Quick-release button opens grip quickly for easy access to gear.
- Heavy-duty base system built for the toughest adventures.
- Easy installation on tubular racks, extension racks, brackets or bumpers.
- Sold in pairs.

CARGO & STORAGE

Log Bars	G2 (6x6 models only)	715001987
-----------------	----------------------	------------------



- Log bars allow you to convert the cargo bed into a perfect transport space for 4' (120 cm) timber.
- The driver's safety is guaranteed by the protective front screen.

Hard Top	G2 (6x6 models only)	715002394
-----------------	----------------------	------------------



- The hard top provides a 116 gal (440 L) cargo box.
- Locking secures your belongings.
- The cover raises assisted by gas cylinders.

Cargo Box Pool

G2L (6x6 models only)

715005256

- Transforms the flatbed into a large capacity cargo box for increased loading possibilities.
- Made of durable formed HDPE and shaped to maximize cargo space.
- Allows access to vehicle's water-resistant rear compartment.
- Designed for perfect fit and easy installation.

Tailgate Extension/Divider

G2 (6x6 models only)

715002017

- The sturdy tailgate extension provides a 10" (25 cm) extension to the cargo space.
- Thanks to the longer cargo bed, even large loads pose no problem.
- With the help of LinQ quick locks, the extension also acts as a solid space divider for the cargo bed.

Tarpaulin

G2 (6x6 models only)

715002416

- Fitted to cover all of the items in your cargo box thoroughly.
- Prevents splash from entering cargo box.
- Easily removable for quick access.

18 Gal (70 L) Utility Box

G2 (6x6 models only)

715001999

- Wherever you go and whatever you do, this handy 18 gal (70 L) utility box is your mobile storage.
- The lid keeps your equipment safe from the elements in all conditions.
- Slides under the flatbed with handles for easy access.

Cargo Box Net

G2 (6x6 models only)

715001371

- Solid net designed to hook to the bottom of the cargo box for secure and compact confinement of your cargo.

Soft Storage Bag

G2, G2L, G2S

715003759

- 3 -section bag.
- Transport gear in a weatherproof bag.
- 11.8 gal (45 L) capacity soft cargo bag designed with vehicle's rack in mind to maximize potential storage.
- LinQ Luggage Rack (715001734) is required for G2S.

Storage 2.6 Gal (10 L) Bag**269502121**

- Roll-Top dry bag for fully protecting your cargo from the elements.
- Fits in rear compartment of your vehicle.

CAN-AM WINDSHIELDS

Deluxe Fairing

G2 (except X mr & 6x6), G2L

- **715001232** · Black
- **715000935** · Yellow 2000
- **715002479** · Light Gray
- **715006125** · Squadron Green
- **715007073** · Tundra Green



- Innovative, richly featured wind protection.
- Quick tool-less removal once base brackets are mounted on handlebar.
- Two cup holders.
- Ready for GPS mounting kit.
- Optional mirrors and auxiliary lighting.
- Requires low, high or extra high windshield.
- Tapered Handlebar Adapter Kit is required for vehicles with 1½" (28 mm) tapered aluminum handlebars.

Camo Decals for Black Deluxe Fairing

(Not illustrated)

Deluxe Fairing

- **715002976** · Mossy Oak Break-Up Country Camo
- **715001684** · Next G-1 Vista Camo

- Camo pattern perfectly matches your camo vehicle.

Tapered Handlebar Adapter Kit

(Not illustrated)

Deluxe Fairing

715002470

- Required to install Deluxe Fairing on an Outlander X-TP and on any vehicle equipped with 1 ½" (28 mm) tapered aluminum handlebars.

Extra High Windshield

Deluxe Fairing

715000936



- 16" (41 cm) windshield provides the ultimate protection against the elements while touring.
- For wind protection and winter applications.
- Tool-less installation and replacement.

High Windshield

Deluxe Fairing

715001211



- 11" (28 cm) high, for wind protection and winter applications.
- Tool-less installation and replacement.

Low Windshield

Deluxe Fairing

715001227



- 6" (15 cm) windshield allows you to keep your vehicle looking sporty while giving you some protection from the elements and the possibility of enjoying directional lighting.
- Tool-less installation and replacement.

Accessories

Auxiliary Windshield Lighting

Deluxe Fairing

715003115



- 2 premium LED spots for Deluxe Fairing for both increased output and directional lighting.
- 1 ,800 lumens.
- 2 x 10W LED Cree light kit.
- Long-range illumination up to 350' (107 m), drawing less than 1 amp per light.

Deluxe Mirror Kit

Deluxe Fairing

715002353



- Improved mounting system.
- Wide rear view.
- Perfect fit with your Deluxe Fairing.

Windshield Kits

Extra High Windshield Kit

G2, G2L, G2S (except X mr models)

715003023



- Made of polycarbonate with integrated vent to reduce air turbulence and rumble noise at high speeds for a quieter and smoother ride.
- Quick tool-less removal once base brackets are mounted on handlebar.
- Fits straight and tapered handlebars.
- Improved design for enhanced rigidity.
- Steering Cover (709400939) is required for XT and Mossy Oak models.
- 16" (41 cm) windshield.
- For ultimate wind protection and winter applications.

High Windshield Kit

G2, G2L, G2S (except X mr models)

715006382



- Made of polycarbonate with integrated vent to reduce air turbulence and rumble noise at high speeds for a quieter and smoother ride.
- Quick tool-less removal once base brackets are mounted on handlebar.
- Fits straight and tapered handlebars.
- Improved design for enhanced rigidity.
- Steering Cover (709400939) is required for XT and Mossy Oak models.
- 11" (28 cm) windshield.
- For wind protection and winter applications.

Low Windshield Kit

G2, G2L, G2S (except X mr models)

715003021



- Made of polycarbonate with integrated vent to reduce air turbulence and rumble noise at high speeds for a quieter and smoother ride.
- Quick tool-less removal once base brackets are mounted on handlebar.
- Fits straight and tapered handlebars.
- Improved design for enhanced rigidity.
- Steering Cover (709400939) is required for XT and Mossy Oak models.
- 6" (15 cm) windshield.
- Allows you to keep your vehicle looking sporty while giving you some protection from the elements.

HANDLEBARS & MIRRORS

Handlebar Wind Deflectors

G2, G2L, G2S



- Rugged injected plastic construction with Can-Am logo.
- Include removable cap for air flow adjustment.
- Mounting kit sold separately.

■ **715000525** · Black / Yellow

■ **715000537** · White / Black

■ **715001706** · Black / Black

■ **715003811** · Can-Am Red / Black

■ **715003812** · Manta Green/Black

■ **715003813** · Orange / Black

■ **715003814** · Octane Blue / Black

■ **715006117** · Squadron Green / Black

■ **715006118** · Viper Red / Black

Passenger Wind Deflectors

G2 and G2L (MAX models only)

715001669



- These wind deflectors fit on the passenger handles and provide greater comfort while riding.
- Easy to install and remove.

Full Wrap Aluminum Mounting Kit

G2, G2L, G2S

715001378



- Lightweight black die cast aluminum construction.
- Includes complete hardware.
- Handlebar wind deflectors sold separately.

Aluminum Tapered Handlebar

G2, G2L, G2S

715000550



- 7/8" - 1 1/8" (22 mm - 28 mm) tapered handlebar made of 6061-T6 aluminum.
- Includes all hardware, center steering foam and cover.

Xt Handlebar Protector Kit	G2, G2L	703100352
-----------------------------------	---------	------------------



- Not compatible with Mud Strap (715003053).

Mirrors Left – 3/8" (10 mm)	G2, G2L, G2S	708200963
------------------------------------	--------------	------------------



- True vision surface 5" x 3" (13 cm x 8 cm).
- Matte finish.
- Stem includes 3/8" (10 mm) thread.
- Bracket (715000190) is required for installation on DS 450.
- Bracket not required for installation on Outlander and Renegade.

Mirrors Right – 3/8" (10 mm) <i>(Not illustrated)</i>	G2, G2L, G2S	709400523
---	--------------	------------------

- True vision surface 5" x 3" (13 cm x 8 cm).
- Matte finish.
- Stem includes 3/8" (10 mm) thread.
- Bracket (715000190) required except for vehicles with right hand brake.

Handlebar Mirrors	G2, G2L, G2S	715005366
--------------------------	--------------	------------------



- Adjustable handlebar mounted convex mirrors.
- The convex surface allows improved visibility with a wider field of view.
- Doesn't require a windshield or fairing to be mounted.

SEATS

Driver Backrest	G2L (except MAX models)	715003941
	G2 (except 6x6 & MAX models)	715003940
	G2 (6x6 models only, except MAX)	715003611



- Provides the rider's back with that extra support that makes riding that extra mile way more comfortable.
- Adjusts horizontally to match the driver's height and preference.
- Mounts and locks in firmly onto the vehicle.

Outlander Max Passenger Seat Kit	G2 2015 & up, G2L (MAX models only)	715002373
---	-------------------------------------	------------------



- Perfect to replace used or damaged passenger seat.

HMWPE SKID PLATES

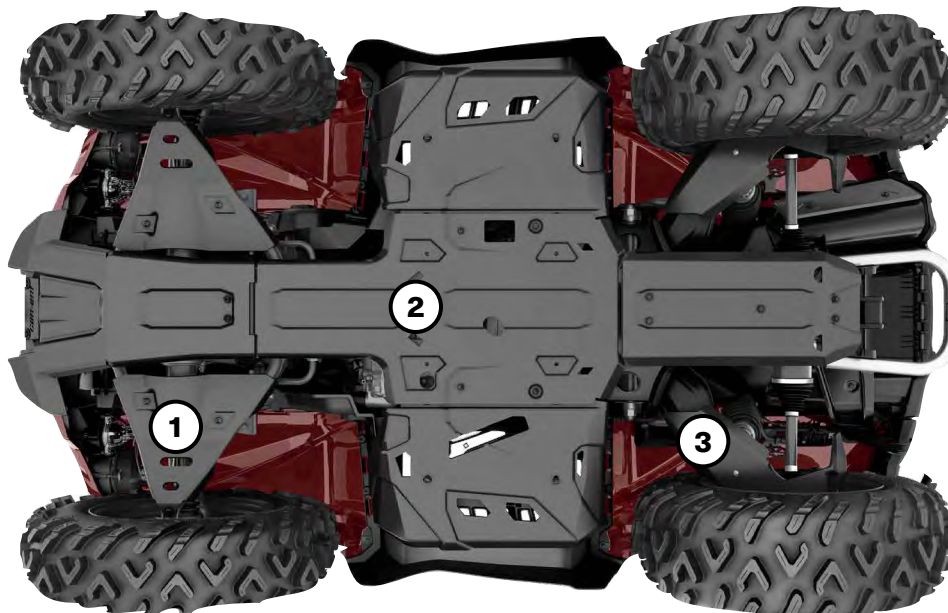

Our plastic plates glide smoothly and silently over obstacles, offering great protection in rough terrain. Made of ¼" (6 mm) thick abrasion-resistant thermoformed High Molecular Weight Polyethylene (HMWPE).

- Lighter than aluminum.
- Superior stress crack resistance.
- High impact strength.

OUTLANDER, RENEGADE

		G2				G2L		G2S	
		2016 & Prior		2017-2018		2019 & Up		2017-2018 Models	2019 & Up
		Except MAX & X mr 1000R models	MAX & X mr 1000R models only	Except Max & X mr 1000R models	MAX & X mr 1000R models only	Except MAX & X mr 1000R models	MAX & X mr 1000R models only	Except MAX models	MAX models only

HMWPE Skid Plate Protection Kit

715004214	715004215	715004209	715004210	715004806	715004807	715004211	715004212	715004213	715004809
-----------	-----------	-----------	-----------	-----------	-----------	-----------	-----------	-----------	-----------

Individual HMWPE Skid Plates

	2016 & Prior	2017-2018	2019 & Up	2017-2018 Models	2019 & Up
① A-Arm Protectors	715002924	715002924	715002924	715002924	715004822
② Underbelly Plates <i>Footwell portion not compatible with Renegade X mr</i>	715002926	715002927	715002926	715002927	715002926
③ Trailing Arm Protectors	-	-	715003466	715003466	715004823

ALUMINUM SKID PLATES

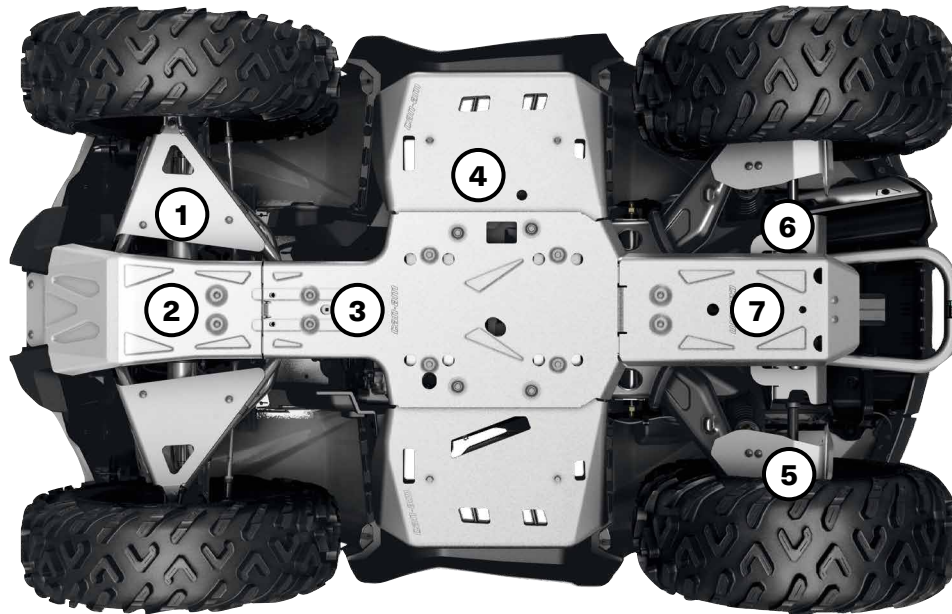

For ultimate durability and strength, all our Aluminum Skid Plates are made with $\frac{3}{16}$ " (4.5 mm) thick High Strength 5052 H32 Aluminum.

- Ultimate durability.
- High strength.

OUTLANDER

G2						G2L	
2016 & prior		2017-2018		2019 & up		Any year	
Except MAX & X mr 1000R models	MAX & X mr 1000R models only	Except MAX & X mr 1000R models	MAX & X mr 1000R models only	Except MAX & X mr 1000R models	MAX & X mr 1000R models only	Except MAX models	MAX models only

Aluminum Skid Plate Protection Kit

715002137	715002138	715004197	715004198	715004804	715004805	715004199	715004200
-----------	-----------	-----------	-----------	-----------	-----------	-----------	-----------

Individual Aluminum Skid Plates

	2016 & prior	2017-2018	2019 & up	2019 & up	2019 & up	2019 & up	2019 & up	2019 & up
① A-Arm Protectors	715001667	715001667	715001667	715001667	715004820	715004820	715001667	715001667
② Front Skid Plate	715000926	715000926	715000926	715000926	715000926	715000926	715001906	715001906
③ Central Skid Plate	715002078	715002078	715002078	715002078	715002078	715002078	715002078	715002078
④ Footwell Protector Plates	715000922	715000922	715000922	715000922	715000922	715000922	715000922	715000922
⑤ Trailing Arm Protectors	—	—	715008595	715008595	715004821	715004821	715008595	715008595
⑥ Rear Differential Protectors	715000920	715000920	715000920	715000920	715000920	715000920	715000920	715000920
⑦ Rear Skid Plate	715002028	715002029	715002028	715002029	715002028	715002029	715002028	715002029

ALUMINUM SKID PLATES



For ultimate durability and strength, all our Aluminum Skid Plates are made with $\frac{3}{16}$ " (4.5 mm) thick High Strength 5052 H32 Aluminum.

- Ultimate durability.
- High strength.

RENEGADE

G2S

	2016 & prior	2017-2018	2019 & up
Aluminum Skid Plate Protection Kit			
<i>Not compatible on X mr models</i>	715002139	715004201	715004808
Individual Aluminum Skid Plates			
② A-Arm Protectors	715001667	715001667	715004820
② Front Skid Plate	715000925	715000925	715000925
③ Central Skid Plate	715002078	715002078	715002078
④ Footwell Protector Plates <i>Not compatible on X mr models</i>	715001359	715001359	715001359
⑤ Trailing Arm Protectors	715001129	715008595	715004821
⑥ Rear Differential Protectors	715000920	715000920	715000920
⑦ Rear Skid Plate	715002028	715002028	715002028

HMWPE & ALUMINUM SKID PLATES

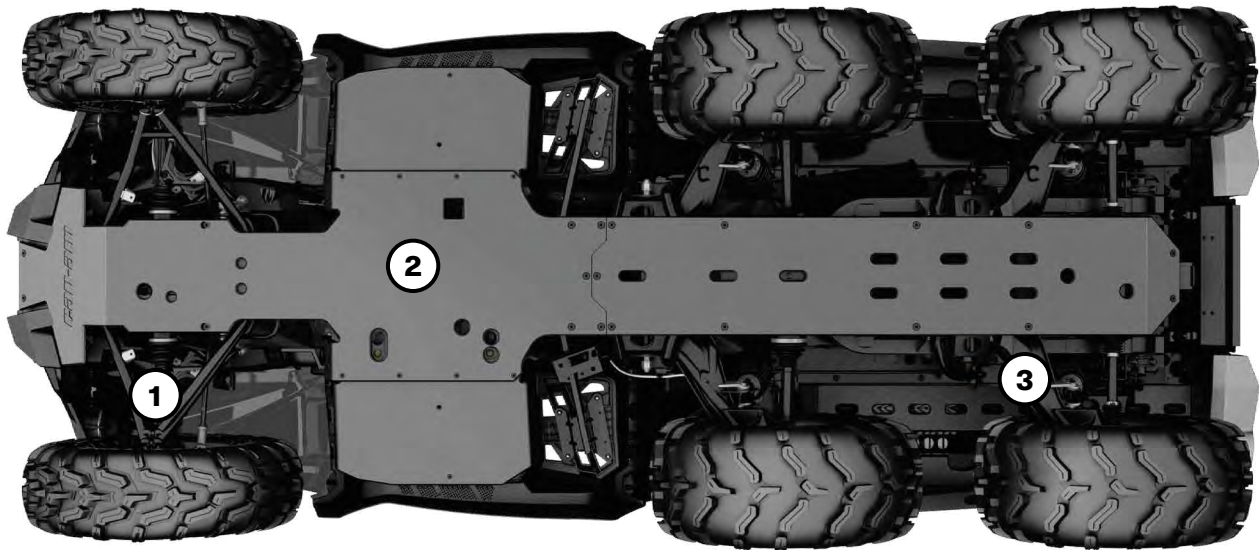

Our Plastic and Aluminum Plates glide smoothly and silently over obstacles, offering great protection in rough terrain.

HMWPE

Made of ¼" (6 mm) thick abrasion resistant thermoformed High Molecular Weight Polyethylene (HMWPE).

- Lighter than aluminum.
- Superior stress crack resistance.
- High impact strength.

ALUMINUM

Made with High Strength ⅜" (4.5 mm) thick 5052 H32 Aluminum.







- Ultimate durability.
- High strength.

OUTLANDER 6X6

	G2 6x6			G2L 6x6
	2016 & prior	2017 - 2018	2019 & up	Any year
Individual HMWPE Skid Plates				
① HMWPE A-Arm Protectors	715002924	715002924	715004822	715002924
② HDPE Full Underbelly Skid Plate	715005290 (except Max)	715005290	715005290 (except Max)	715005259 (Max Only)
	715003647 (Max Only)	715003647	715003647 (Max Only)	
③ HMWPE Trailing Arm Protectors	-	715003466	715004823	715003466 (2020 models & prior only)
Individual Aluminum Skid Plates				
① Aluminum A-Arm Protectors	715001667	715001667	715004820	715001667
② Aluminum Full Underbelly Skid Plate				
③ Aluminum Trailing Arm Protectors		715008595	715004821	715008595

BUMPERS & GUARDS

Bumpers

Expedition Front Bumper	G2, G2L (except X mr models & X xc models 2022 & up)	715007233
	<ul style="list-style-type: none"> • Made of 1.5" profiled steel tubes for complete protection of the vehicle's front. • Protects and doesn't obstruct the vehicle's headlights. • Integrated mounting spots for lights. • Inside and outside anticorrosion coating with a durable powder coat finish. 	
Expedition Rear Bumper	G2, G2L	715007234
	<ul style="list-style-type: none"> • Made of 1.5" profiled steel tubes for complete protection of the vehicle's rear. • Protects and doesn't obstruct the vehicle's taillights. • Inside and outside anticorrosion coating with a durable powder coat finish. • G2 base and DPS rear bumper installation requires 705008164 and 705008165. 	
NEW X mr Front Bumper	G2S 2023 & up	715008198
	<ul style="list-style-type: none"> • Enhanced vehicle front protection. Required as a mounting point for Radiator Relocator (715008898). 	
XT Front Bumper	G2	715004837
	<ul style="list-style-type: none"> • Provide additional protection against obstacles. • Tough and durable, can be added on base Outlander model to convert vehicle into XT model. • Standard on XT, XT-P, Mossy Oak and Limited models. • Large tube construction with textured black finish and metal corners. 	
XT Rear Bumper	G2	715004920
	<ul style="list-style-type: none"> • Provide additional protection against obstacles. • Tough and durable, can be added on base Outlander model to convert vehicle into XT model. • Standard on XT, XT-P, Mossy Oak and Limited models. • Large tube construction with textured black finish and metal corners. 	
XT Front Bumper	G2L	715001910
	<ul style="list-style-type: none"> • Winch compatible. • Large tube construction. • Protects vehicle against obstacles. • Standard on XT models. 	
XT Rear Bumper	G2L	715001911
	<ul style="list-style-type: none"> • Large tube construction. • Protects vehicle against obstacles. • Standard on XT models. 	

Extreme Front Bumper	G2	715001286*
	G2L	715004279



- Ultra-sturdy build.
- Enhances front-vehicle protection.
- Compatible with XT Front Bumper.
- Fits the Apache™ 360 Track System (when side panels are removed).

**Not compatible with Front Hitch.*

Complete Rancher Protection Kit	G2, G2L (except X mr & 6x6 models)	715003463
--	------------------------------------	------------------



- These heavy-duty bumpers and fender guards are designed to pull double duty: protect your ATV and anything it comes in contact with, while also enhancing the look of your ATV.
- Made tough and designed to deliver a rugged appearance, together they offer front, rear and full side protection for farmer, rancher and forestry applications.
- Requires Body Side Protector Extensions (715003460) for installation on MAX models.
- This kit includes:
 - Rancher Front Bumper (715003461).
 - Rancher Rear Bumper (715003462).
 - Body Side Protector (715003459).

Rancher Front Bumper	G2, G2L (except X mr models)	715003461
-----------------------------	------------------------------	------------------



- The low front end protection and plates allow you to use your ATV within cattle herds and guard the safety of both the vehicle and the animals.
- The flat front portion facilitates gently prodding cattle or pushing light objects, e.g. closing a fence.
- The full frontage coverage extends to provide an extra layer of defense to your headlights and radiator.
- Inside and outside anti-corrosion coating with durable powder coat finish.
- Not compatible with track systems, plows and front hitch.

Rancher Rear Bumper	G2, G2L (except 6x6 models)	715003462
----------------------------	-----------------------------	------------------



- Ideal for using your ATV within cattle herds and guarding the safety of both the vehicle and the animals.
- Coverage extends to provide an extra layer of defense to your tail lights.
- Inside and outside anti-corrosion coating with durable powder coat finish.
- Not compatible with track systems.

Renegade Extreme Front Bumper	G2S 2022 and prior (except X mr models)	715002469
--------------------------------------	---	------------------



- Enhanced vehicle front protection.
- Required as a mounting point for Radiator Relocator (715008898).

Guards

Body Side Protector	G2 2012 to 2018 with stock XT Bumper, G2 2012 & up with Rancher Bumper, G2L with Rancher Bumper, (except X mr and 6X6 models)	715003459
	G2 2019 & up with XT Bumpers, (except X mr and 6X6 models)	715004940*
	G2L with XT Bumpers, (except X mr and 6X6 models)	715003614



- The heavy-duty fender guard designed to pull double duty, protecting your ATV and also enhancing the look of your ATV.
- Made tough and designed to deliver a rugged appearance, this fender guard offers full side protection for farmer, rancher and forestry applications.
- Built of durably bold 1.25" (3 cm) diameter steel-tube construction, with inside and outside anti-corrosion coating with durable powder coat finish.
- Not compatible with Self Clearing Footwell.
- XT Front and Rear Bumpers or Rancher Front and Rear Bumpers are required for installation.
- Requires Body Side Protector Extensions (715003460) for installation on MAX models.

**Not compatible with Front and Rear Rancher Bumpers.*

Body Side Protector Extensions <i>(Not illustrated)</i>	G2, G2L (MAX models only)	715003460
---	---------------------------	------------------

- This specially designed extension for the Body Side Protector is made specifically to fit and seamlessly integrate into the look of Outlander MAX models.

Mud Flaps	G2 (with stock fender flares)	715007089
------------------	-------------------------------	------------------



- Keeps mud, snow and debris out of cargo area and protects trailer and vehicles behind you.
- Adds aesthetic appearance to your vehicle.
- Requires stock fender flare.
- Sold in pairs.

Fender Flares	G2 2012-2018 (except with 30" tyres) (except 6x6 models)	715001764*
	G2 2019 & up (with 30" tyres) (except 6x6 models)	715004250**
	G2L	715001909***
	G2L European vehicles only 2015 & up	715004487



- Kit designed to deliver extra protection from dirt and debris, therefore a must if you enjoy riding in the mud.
- Made of injected plastic that hugs your vehicle fenders perfectly.
- Gives vehicle added flair for that rugged cool look.
- Includes front and rear extensions and all mounting hardware.

**Comes stock on G2 models 2019 & up (except X mr models).*

***Standard on G2 X mr 1000R.*

****Not compatible with European vehicles.*

Fender Flare Extensions	G2 (except 6x6 models)	715005111*
	G2L	715003615**



- Block terrain debris from kicking up onto you as you ride or damaging your vehicle thanks to these extra-large Fender Flare Extensions, which also include mud flaps for added protection from mud/snow, especially when riding with track kits.
- Made of High Molecular Weight Polyethylene (HMWPE) for advanced abrasion resistance.
- Include front and rear extensions.

**Must be used with Fender Flare for G2 (715001764).*

***Must be used with Fender Flare for G2L (715001909).*

Fender Flares	G2S (except X mr models)	705012695
----------------------	--------------------------	------------------



- Integrated extended Fender Flares for sporty look and full body protection from dirt and water.
- Include front and rear extensions and all mounting hardware.

Flatbed Protection Tubes	G2 (6x6 models only)	715002030
---------------------------------	----------------------	------------------



- Bolt-on bumpers for the sides of the 6x6 flatbed.
- Protect the exterior plastic components of the flatbed from rocks, trees and other obstacles when traversing enclosed areas or loading cargo onto the bed.







Flatbed Protection Tubes	G2L (6x6 models only)	715005266
---------------------------------	-----------------------	------------------



- Bolt-on bumpers for the sides of the 6x6 flatbed.
- Protect the exterior plastic components of the flatbed from rocks, trees and other obstacles when traversing enclosed areas or loading cargo onto the bed.

LIGHTS & ELECTRICAL

Integrated Heated Grips & Thumb Throttle Combo	G2, G2L, G2S (2021 & up)	715005072
	<ul style="list-style-type: none"> • Heat levels for grips and thumb displayed on vehicle screen. • Ergonomic button integrated on LH grip. • Single button for both grips and thumb heat selection. • Five temperature settings for the thumb and grips. • Adjustable heat ratio between grip and thumb warmer. 	<ul style="list-style-type: none"> • Hold button to reach maximum heat quickly. • Remembers your last heat setting. • IP67-rated waterproof sealing keeps the elements out. • ECE compliant. • Plug-and-play installation. • Clamp-on grips, no glue required.
Heated Grips & Thumb Throttle Combo	G2, G2L, G2S (except 2020 & up models equipped with 850 engine and 2019 & up models with 1000R engine, T Category models)	715003250 Not compatible with Intelligent Throttle Control (iTC)
	G2, G2L, G2S (2020 & up models equipped with 850 engine and 2019 & up models with 1000R engine, T Category models)	715008739 Compatible with Intelligent Throttle Control (iTC)
Wiring Cable <i>(Not illustrated)</i>	G2L	710004567
Heated Visor Outlet	G2, G2L	715001246
	<ul style="list-style-type: none"> • Strategically positioned on vehicle to maintain your agility. • Optional visor outlet that delivers fog-free riding. • Quick and easy installation. • Sold individually. • Heated Visor not included. 	
Heated Passenger Grips & Visor Outlet	G2, G2L (MAX models only)	715008794
	<ul style="list-style-type: none"> • Replace your stock passenger handles. • Dual temperature switch integrated into seat arm for 3-zone heated handles and grips. • Heated visor outlet integrated into seat arm. 	
USB Power Outlet Kit	G2, G2L, G2S	219400510
	<ul style="list-style-type: none"> • Recharges your electronic devices while riding* (smartphone, MP3, heating gear, etc.). • Dual port USB connectors. • The power outlet is not capable of recharging all device types while riding. 	
Seat Heater	G2, G2L	715007211
	<ul style="list-style-type: none"> • 25 W seat heater delivers chill-free riding comfort. • One temperature only. • Heated pad and electrical harness only. • Heavy Duty Seat Cover (715007212) is required for the installation. 	
Heavy-Duty Seat Cover	G2, G2L	715007212
	<ul style="list-style-type: none"> • Heavy-duty materials to cover and protect the seat. • Abrasion- and tear-resistant. • Simply installs by stretching around the original seat; the elastic holds the cover securely in place. 	

Electronic Device Holder	G2, G2L (except 6x6 & X mr models)	715004919
	<ul style="list-style-type: none"> • Robust injected-polypropylene construction allows for the right fit and easy installation. • Adjustable unit safely holds smartphones or small tablets with a length or width measuring between 2.9" (7.5 cm) and 5.1" (13.0 cm) with or without protective case. • Integrated storage (0.6 gal / 2.1 L). 	<ul style="list-style-type: none"> • Guiding wire grooves to pass charging cable through the lid. • Possibility of relocating 12V power outlet or installing USB outlet in storage compartment (USB power outlet sold separately). • Not compatible with windshields or Snorkel Kit.
3.5" (9 cm) LED Lights (2 X 14W) LED Driving Lights	G2, G2L (except X mr models)	715003666
	<ul style="list-style-type: none"> • 14W LED lights producing 1,260 lumens each. • Equipped with 6 high power LEDs in a heavy-duty die cast aluminum housing. • Features 2 attachment points — if one attachment point fails due to a collision, rotate to the next channel point and re-mount the light. 	<ul style="list-style-type: none"> • Sold in pairs. • EC compliant. • Spot lens for a narrow and long light beam spread, ideal when driving at higher speeds. • Expedition Front Bumper (715007233) and Light Power Cable (715007275) required for installation.
3.5" (9 cm) LED Lights (2 X 14W) LED Flood Lights	G2, G2L (except X mr models)	715003665
	<ul style="list-style-type: none"> • 14W LED lights producing 1,260 lumens each. • Equipped with 6 high power LEDs in a heavy-duty die cast aluminum housing. • Features 2 attachment points — if one attachment point fails due to a collision, rotate to the next channel point and re-mount the light. 	<ul style="list-style-type: none"> • Sold in pairs. • EC compliant. • Flood lens for a wide light beam spread, ideal for working applications like plowing or for cornering, dusty or foggy riding conditions. • Expedition Front Bumper (715007233) and Light Power Cable (715007275) required for installation.
4" (10 cm) Round LED Lights (2 x 25 W)	G2, G2L (except X mr models)	715002935
	<ul style="list-style-type: none"> • 25 W LED spotlights. • 1,800 lumens. • Rugged and waterproof. • Includes basic wiring and switch. • Can-Am branded grill. 	<ul style="list-style-type: none"> • Sold in pairs. • Not EC compliant. • Expedition Front Bumper (715007233) and Light Power Cable (715007275) required for installation.
10" (25 cm) Double Stacked LED Light Bar (60 Watts)	G2, G2L (except X mr models)	715002933
	<ul style="list-style-type: none"> • Equipped with 12 5W Cree LEDs. • 5,400 lumens. • Rugged and waterproof. • Packs a big punch for its size. 	<ul style="list-style-type: none"> • EC compliant. • Expedition Front Bumper (715007233) and Light Power Cable (715007275) required for installation.
Light Power Cable <i>(Not illustrated)</i>	G2, G2L	715007275
<ul style="list-style-type: none"> • Required for installation of the 10" (25 cm) LED Light Bar, the 3.5" (9 cm) and 4" (10 cm) LED Lights. 		
Bluetooth Handlebar Soundbar by Mtx	G2, G2L, G2S	219400840
	<ul style="list-style-type: none"> • Bluetooth speaker with the unbeatable convenience of fingertip control. • Rugged IP66-rated weather-resistant speaker designed for outdoor use. • Driven by 150 watts of quality audio power. • Seamless integration and operation from Bluetooth enabled devices. 	<ul style="list-style-type: none"> • Includes input, ground and ignition wires, plus auxiliary port and 3.5" (8.89 cm) connector cable. • Not compatible with XT Handlebar Protector Kit. • EC compliant. <p><i>Note: We recommend you use 320 Kbps MP3 - 192-256 Kbps AAC or AIFF, WAV formats to match the potential of the speaker. More compressed formats will probably have degraded sound quality.</i></p>
Multi Position Light Mount Kit	G2, G2L, G2S	715004274
	<ul style="list-style-type: none"> • Multi-position plastic clamps that fit on various tubing sizes: 0.75" to 1.5" (19 mm to 38 mm). • Required for the installation of the 2" (5 cm) Square LED Lights (2 x 10W). • Kit includes tube clamp mounts and power cables. 	

Baja Designs High Beam Kit

G2 (2022 and prior)

715004284

- Thanks to their direct bolt-on and plug-and-play installation right into the original high beam location, upgrading from your stock high beam lights to these powerful Baja Designs Squadron Pro LED Lights becomes child's play.
- Each spot is equipped with 4 Cree LEDs producing 4,900 lumens at 40 watts.
- Driving/Combo light pattern for smooth blend of light for both near field applications and distance.

2" (5 cm) Square LED Lights (2 X 10 Watts)

G2, G2L, G2S

715004293

- 2 x 900 lumens 10W LED Cree light kit.
- Long-range illumination up to 350' (107 m), drawing less than 1 amp per light.
- Multi-Position Light Mount Kit is required for installation.
- Not EC compliant.

RAM[†] LED Spotlight

G2, G2L, G2S

710005423

- 540 lumens LED light (9W) heavy-duty spotlight standard-equipped with 1" (2.5 cm) diameter rubber-coated double ball and socket system.

Center Console Day Light

G2S (except X mr)

715000691

- Mountable on top end of center console.
- Enhances look of vehicle.

Battery Charger/Maintainer**715005061**

- Keeps stored lead-acid batteries charged.
- Charges and maintains small batteries.
- Microprocessor controlled multi-stage charging for added precision, safety and battery life.
- Automatically detects 6- or 12-volt batteries.
- Reverse hook-up protection helps protect battery and charger from damage.
- Auto-voltage detection.
- Press the display button to show the charge progress.
- Content: 3 amp battery charger, clamp adapter, DC adapter, 24" (61 cm) fused ring leads harness with weather cap, owner's manual.
- Not EC compliant.

Jump Starter**715005062**

- IPX3 water-resistant and enclosed output ports.
- 4 LED battery indicators for easy read on battery charge level.
- Compact design, will conveniently fit in your backpack, glove box or any other storage compartment.
- 2.4A + 1A/5V USB ports for fast charging of all USB devices.
- Smart cable provides protection against reverse polarity, short circuit, low voltage, high temperature and reverse charging.
- Built-in LED light (3 modes).
- Content: 300CA jump starter, SA858 smart cable clamp, MC-USB to USB charging cable, travel bag, user manual.
- Not EC compliant.

Quick Connect Battery Cable**715005408**

- Quickly and easily connect and charge different items with your charger.
- Included in the Battery Charger/Maintainer (715005061).
- Sold individually.

Quick Connect Cable with Battery Indicator**715006055**

- Quickly and easily connect and charge different batteries with your charger.
- 3-colour LED indicator provides constant battery health indication.
- Sold individually.

GPS RAM Mount for Handlebar

G2, G2L, G2S

715001985
While supplies last

- Convenient bracket for installing the Garmin Montana GPS (not included) onto your unit's handlebar.

Digitally Encoded Security System (D.E.S.S.) Green Key

G2, G2S (2018 & up)

710005232

- Anti-theft technology, Digitally Encoded Security System (D.E.S.S.) key snaps easily on the vehicle and provides riders easy and quick starts every time.
- The key communicates with the vehicle wirelessly so the vehicle starts only when the key code matches the vehicle, for ultimate peace of mind.
- The Programmable D.E.S.S. Key can also be programmed to 3 modes:
 - Work mode: Limits vehicle speed to 40 kph (25 mph) but does not limit engine torque.
 - Normal mode: Limits vehicle speed to 70 kph (44 mph) and 50% torque reduction.
 - Performance mode: No restrictions.

WINCHES

Can-Am HD Winches

Can-Am HD 2500 Winch

G2, G2L

715006414



- Heavy-duty four-way roller fairlead.
- Ergonomic clutch handle.
- Rugged all-steel gears and bushings provide more torque and longer life.
- Automatic 100% load-holding brake.
- Sealed solenoid for all-weather protection.
- Wired Remote Control sold separately.
- Plug-and-play wiring and attachment brackets.
- Weather-sealed handlebar-mounted switch.
- Pulling strength capability of 2,500 lb (1,134 kg).
- 50 ft. of $\frac{3}{16}$ " (15.2 m of 4.8 mm) wire steel cable.
- EC-compliant.

Can-Am HD 3500 Winch

G2, G2L

715006415



- Heavy-duty four-way roller fairlead.
- Ergonomic clutch handle.
- Rugged all-steel gears and bushings provide more torque and longer life.
- Automatic 100% load-holding brake.
- Sealed solenoid for all-weather protection.
- Wired Remote Control sold separately.
- Plug-and-play wiring and attachment brackets.
- Weather-sealed handlebar-mounted switch.
- Pulling strength capability of 3,500 lb (1,588 kg).
- 50 ft. of $\frac{3}{16}$ " (15.2 m of 4.8 mm) wire steel cable.
- EC-compliant.

WARN⁺ VRX Winches

WARN VRX 25 Winch

G2, G2L, G2S

715006107



- Extreme IP68-rated waterproof sealing keeps the elements out.
- Durable all-metal construction.
- Black powder-coated finish and stainless-steel fasteners for corrosion resistance.
- Robust new clutch design based on 70+ years of WARN 4WD hub lock know-how.
- Handlebar-mounted rocker control.
- Load-holding brake for great control.
- Smooth and reliable all-metal three-stage planetary gear train.
- Limited lifetime warranty (mechanical), 3-year warranty (electrical).
- Pulling strength capability of 2,500 lb (1,134 kg).
- 50 ft. of $\frac{3}{16}$ " (15 m of 4.8 mm) wire steel cable.
- Roller fairlead.
- Wire harness (715002453) required for installation.
- Winch mounting plate is required for G2S (STD & X xc 2022 & prior only).
- EC-compliant.

WARN VRX 35 Winch

G2, G2L, G2S

715006108



- Extreme IP68-rated waterproof sealing keeps the elements out.
- Durable all-metal construction.
- Black powder-coated finish and stainless-steel fasteners for corrosion resistance.
- Robust new clutch design based on 70+ years of WARN 4WD hub lock know-how.
- Handlebar-mounted rocker control.
- Load-holding brake for great control.
- Smooth and reliable all-metal three-stage planetary gear train.
- Limited lifetime warranty (mechanical), 3-year warranty (electrical).
- Pulling strength capability of 3,500 lb (1,361 kg).
- 50 ft. of $\frac{7}{32}$ " (15 m of 5.5 mm) wire steel cable.
- Roller fairlead.
- Wire harness (715002453) required for installation.
- Winch mounting plate is required for G2S (STD & X xc 2022 & prior only).
- EC-compliant.

WARN VRX 35-S Winch

G2, G2L, G2S

715006109



- Extreme IP68-rated waterproof sealing keeps the elements out.
- Durable all-metal construction.
- Black powder-coated finish and stainless-steel fasteners for corrosion resistance.
- Robust new clutch design based on 70+ years of WARN 4WD hub lock know-how.
- Handlebar-mounted rocker control.
- Load-holding brake for great control.
- Smooth and reliable all-metal three-stage planetary gear train.
- Limited lifetime warranty (mechanical), 3-year warranty (electrical).
- Pulling strength capability of 3,500 lb (1,361 kg).
- 50 ft. of $\frac{3}{16}$ " (15 m of 4.8 mm) synthetic rope.
- Cast aluminum fairlead.
- Wire harness (715002453) required for installation.
- Winch mounting plate is required for G2S (STD & X xc 2022 & prior only).
- EC-compliant.

Winches Accessories

Wireless Remote Control

WARN Winches

715002542



- The system is quick and easy to install, thanks to a wiring harness with an integrated antenna and all necessary mounting hardware.
- The system allows you to operate your winch from anywhere within a 50' (15.2 m) radius, increasing your recovery options.
- All components are weatherproof.

Wired Remote Control

WARN Winches

715006378

Can-Am HD Winches (715006414 & 715006415)

715006555

Can-Am HD Winches (715008140 & 715008141)

715008121



- This kit allows winch owners to add the hand-held remote to their winch.
- This kit allows winch owners to add the handheld remote to vehicles with a stock winch.
- Works in conjunction with the mini-rocker switch.
- Wired Remote & Remote Socket included.
- EC-compliant.

Winch Accessories Kit

715002409



- Get the most out of your winch.
- Double your pulling power, change your pulling direction and keep your winch in proper working order.
- Includes tree straps, snatch block, shackle and winching gloves.

WARN Hawse Fairlead

WARN Winches

715007698



- Double powder-coated construction.
- Required to use the Synthetic Winch.
- Cable (715004254) on WARN winches.
- To be used with synthetic winch cables only.

Roller Fairlead

WARN Winches

715007699

Can-Am HD Winch

710007459



- Features top, bottom and side rollers for less cable wear and smoother operation from any direction for easier winching.

Hook with Safety Latch & Strap Kit

Can-Am HD Winches

705014949



- Heavy-duty winch-rope hook with stainless steel snap.
- Includes a nylon safety strap.

Replacement Wire Rope – Can-Am HD

705014983

705014984



- Play it safe, always carry a replacement wire rope.
- 2,500 lb (1,134 kg) pulling strength with 50 ft of $\frac{3}{16}$ " (15.2 m of 4.8 mm) wire rope for 705014983.
- 3,500 lb (1,588 kg) pulling strength with 50 ft of $\frac{7}{32}$ " (15.2 m of 5.5 mm) wire rope for 705014984.

Replacement Wire Rope – ATV WARN Winches**715006256**

- Play it safe, always carry a replacement wire rope.
- 3,500 lb (1,588 kg) pulling strength.
- 50 ft. of 7/32" (15.2 m of 5.5 mm) aircraft grade steel wire.

Synthetic Winch Cable

ATV WARN Winches

715004254

- Easier to manipulate than steel cable.
- Replaces the original cable on any factory installed WARN winch or sold as an accessory by BRP.
- Kit includes synthetic rope and rock guard sleeve.
- Always use with the new Hawse Fairlead (715007698).
- 50 ft. (15.2 m) of 3/16" (15.2 m of 4.8 mm) synthetic rope.
- 3,500 lb (1,588 kg) pulling strength.

Winch Mounting Plate

G2S

715000927

- Adds functionality to your Renegade.
- Fits Can-Am winches by WARN.

Winch Wire Harness*(Not illustrated)*

G2 2021 & up, G2S 2021 & up and G2L

715002453

- Required plug-and-go wiring to install WARN winch only.
- Not required for Can-Am HD winches.

HITCHES

Hitches**Rear Hitch**

G2, G2L (except 6x6 models), G2S

715001925

- E-coat finish.
- Fixed hitch ball mounting bracket.
- Provides fixed mounting point for trailer ball to provide vehicle with towing capabilities.
- This hitch offers 1,300 lb (590 kg) of towing capacity.
- Hitch ball not included.

Front and Rear Hitch Drawbar

G2, G2L, G2S

715008350

- Standard on 2" (5 cm) receiver hitch.
- It offers 1,650 lb (750 kg) of towing capacity.
- Hitch ball not included.
- Forged steel.

Hitches Accessories

Rear Receiver Hitch

G2S 2012 with 800R or 1000 engines G2S 2013 & up, G2L & G2

715005186



- E-coat finish.
- Does not affect ground clearance.
- Trailer ball not included.
- On 4X4 use, this hitch offers 1,500 lb (680 kg) of towing capacity.
- On 6x6 use, this hitch offers 1,654 lb (750 kg) of towing capacity.
- Compliant with European T regulations.
- Not compatible with G2L models with Rear Skid Plates.

Front Receiver Hitch

G2

715000921



- Front receiver hitch for Outlander with or without a winch.
- This hitch offers 1,300 lb (590 kg) of towing capacity.
- Allows you to maneuver your trailer easily in tight, confined areas.
- Hitch bar sold separately.
- Not compatible with Extreme Front Bumper, Rancher Bumper and ProMount Plows.

Rubber Receiver Plug

705204503



- Rubber cap for 2" (5 cm) hitch receiver.

PERFORMANCE

Performance

Renegade Snorkel Kit

G2S (2020 & prior)

715006000

G2S (2021 & up)

715007083



- Comprehensive kit.
- Extended air intakes and CVT exhaust.
- CVT outlet integrates into pod cover.
- Ideal for muddy conditions.

Renegade Radiator Relocator Kit

G2S 2023 & up

715008898

G2S 2022 & prior

715001929



- Relocates radiator to top mount position.
- Prevents cooling performance loss in muddy conditions.
- Uses existing radiator.
- Includes support, hardware and hoses.
- Engineered for easy cooling system bleeding and maintenance.
- Radiator not included.
- Renegade Extreme Front Bumper (715002469) required for G2S 2022 and prior or X mr Front Bumper (715008198) required for 2023 and up for installation (except X mr).

Mud Strap

G2, G2L, G2S

715003053



- Convenient sturdy grab-handle.
- Lets drivers redistribute their weight for improved traction in demanding conditions.
- Not compatible with XT Handlebar Protector Kit (703100352).

Radiator Protector	G2, G2S (except G2S with 500 engine)	715001744
	<ul style="list-style-type: none"> • Metal shield that mounts over radiator face, providing protection from stones and branches. 	
Outlander Snorkel Kit	G2 2015 & up, G2L (except X mr & 6x6 models)	715005999
	<ul style="list-style-type: none"> • Comprehensive kit. • Extended air intakes and CVT exhaust. • CVT outlet integrates into pod cover. • Must be installed on a vehicle without XT Handlebar Protector Kit. • Ideal for muddy conditions. • Not compatible with windshields. 	
Outlander Snorkel Kit	G2 (X mr models only), G2L (X mr models only)	715002518
	<ul style="list-style-type: none"> • Comprehensive kit. • Extended air intakes and CVT exhaust. • CVT outlet integrates into pod cover. • Must be installed on a vehicle without XT Handlebar Protector Kit. • Ideal for muddy conditions. • Not compatible with windshields. • Raised horn only. • Provides higher intake. • For best fit and finish, appropriate gauge support is required. 	
Outlander Radiator Relocator Kit	G2, G2L (except 6x6 models)	715001930
	<ul style="list-style-type: none"> • Relocates radiator to top mount position. • Prevents cooling performance loss in muddy conditions. • Uses existing radiator. • Includes support, hardware and hoses. • Engineered for easy cooling system bleeding and maintenance. • Radiator not included. 	
X mr Traction Plates	G2 (MAX models only), G2L	715001752
	<ul style="list-style-type: none"> • Provide extra foot grip for driver when riding in extreme mud conditions. • Help driver maintain ideal riding position to maximize vehicle traction. • Made of aluminum. • Not meant for a passenger. 	
Self-Clearing Footwells	G2 2015 & up, G2L	715004759
	<ul style="list-style-type: none"> • Made from aluminum. • Replace original footwells. • Feature large evacuation ports to avoid mud and snow accumulation in footwells. • Aggressive design for improved traction. • Not compatible with Body Side Protectors. • Sold in pairs. 	
Footpeg Kit	G2, G2L	715001131
	<ul style="list-style-type: none"> • Provides maximum integrated grip and more stability during vigorous riding. • Kick-up end generates added grip during hard cornering. • Made of aluminum. • Sold in pairs. 	

Foam Air Filter by Twinair†

G2, G2S, G2L

715001333



- Maximizes performance by increasing air flow throughout RPM range.
- Maintenance-friendly, i.e., just wash, re-oil and re-use after riding in severely dusty/muddy environments.

Heavy-Duty Springs

G2 2012-2018 (Base model, DPS, XT, X mr with 650 engine only & Limited – except 6x6)
G2S (Base model with 500 & 570 engines only)

715003199 · Front

G2L (except Mossy Oak, PRO, 6x6 and X mr models)

715007203 · Front

G2 2012-2018 (Base model, DPS, XT & X mr with 650 engine only – except 6x6)
G2S (Base model with 500 & 570 engines only)

715003200 · Rear

G2 2019 & up (Base, DPS & XT models, except 6x6)

715005159 · Front & Rear



- Heavy-duty springs provide enhanced stiffness.
- Perfect for snow clearing and hauling heavy loads.
- Improves handling and helps prevent accidental overturns.
- Kit includes 4 springs.
- Standard on Outlander PRO and Mossy Oak models.

Front Shock Covers

G2, G2L, G2S

715500301

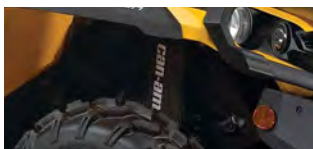

- Feature ventilation holes.
- Offer added protection in rough terrain and weather conditions.
- Sold in pairs.

Yoshimura

Yoshimura Slip-On Exhaust – Outlander

G2 (except 6x6 models)

715005480



- Made from 304-grade stainless steel.
- Better sounding, better looking and lighter than stock muffler.
- USDF/USDA approved spark arrester.
- Non-EPA compliant (for racing application only).
- Not EC compliant.
- Fuel injection system tuning not required.
- Not compatible with CARB & T Category models 2018 & up, NRMM & 650 Engine 2022 & up.

Yoshimura Slip-On Exhaust – Renegade

G2S 2012 & up (except 570 engine and X mr models)

715005481



- Made from 304-grade stainless steel.
- Better sounding, better looking and lighter than stock muffler.
- USDF/USDA approved spark arrester.
- Non-EPA compliant (for racing application only).
- Not EC compliant.
- Fuel injection system tuning not required.
- Not compatible with CARB & T Category models 2018 & up, NRMM & 650 Engine 2022 & up.

Emergency Accessories

Emergency Kit

715006102



- Complete emergency kit provides all essential equipment and supplies to get out of most unfavorable situations powersport enthusiasts may find themselves in.
- Includes jumper cables, air compressor, tyre-repair kit, first-aid kit, ratchet tie-down, duct tape, 3,300 lb (1,500 kg) tow strap, zip-ties and cloth rags.

COVERS, DECALS & ADD-ONS

Trailer Covers	G2 (except MAX models)	715001737
	G2 (MAX and X mr 1000R models only)	715001736
	G2L (except MAX models)	715002026
	G2L (MAX models only)	715002025
	G2S (except X mr models)	715000683



- Heavy-duty canvas made of UV-resistant solution-dyed polyester.
- Protect windshield and coloured panels from abrasion.
- All high-abrasion areas are reinforced with a double canvas layer.
- Opening for fuel cap access.
- Weather-resistant trailable cover protects your vehicle during transportation.
- Quick and easy installation.
- Designed to perfectly fit your vehicle with or without Can-Am accessories.

Storage Covers	G2, G2L, G2 X mr (except 1000), G2L X mr, G2S, G2S X mr	715001720
	G2, G2L (MAX and X mr 1000R models only)	715001668
	G2 (6x6 models only)	715002492
	G2, G2L (except MAX models)	■ 715001597 · Mossy Oak Break-Up Country Camo
	G2 MAX, G2 X mr 1000, G2L MAX	■ 715001735 · Mossy Oak Break-Up Country Camo



- Weather-resistant storage covers.
- For vehicle storage only.
- UV-resistant solution-dyed polyester construction.
- Quick and easy installation.
- Designed to perfectly fit your vehicle with or without Can-Am accessories.

Flag	■ 715000277 · Yellow
-------------	-----------------------------



- Make sure everyone knows what you're riding.
- Perfect for the dunes and new riders.
- 8-ft. (2.4 m) length.
- Includes flag mount (715000127).

Flag Mount <i>(Not illustrated)</i>	715000127
---	------------------

Bolt-On[†] Retractable Ratcheting Tie-Downs	295100737
---	------------------



- Perfect for transporting your powersport vehicle or securing loads.
- Mounts easily: Bolts on any flat surface (e.g., truck bed or frame).
- 1" x 6' (2.5 cm x 1.8 m) tie-down strap with heavy-duty stitching that delivers a 500 lb (226 kg) working load strength and 1,500 lb (680 kg) break strength.
- Convenient retractable push button automatically slackens, spools and stores away strap, while the ratchet mechanism tightens the strap snugly to secure your vehicle or load into place.
- Rubber ratcheting handle provides firm grip, and the hook is vinyl coated to protect whatever surface it hooks into.
- Sold in pairs.

Ratchet Tie-Downs	■ 715008309 • Black/Gray
--------------------------	------------------------------------



- 400 lb (181 kg) safe working load.
- 1" x 10' (2.5 cm x 3 m) strap with Can-Am, Sea-Doo, and Ski-Doo logos.
- Deluxe ratchet with rubber handle.
- Coated S hooks.
- Pack of 2.

Heavy-Duty Ratchet Tie-Down**715008308**

- 1,000 lb (454 kg) safe working load.
- 1.5" x 6' (38 mm x 1.8 m) strap with BRP brands.
- Deluxe ratchet with rubber handle.
- Black-coated clip hooks.
- 12" (300 mm) webbing included.
- Pack of two.

Shifter Lock

G2, G2L

715007337

- Secure the vehicle's shifter by locking it in position.
- Prevents the vehicle from going into neutral without the lock key.

Lockable Gas Tank Cap

G2, G2L, G2S

860200387

- Protects your fuel.
- Meets EPA requirements.

License Plate Bracket

G2L

715002498

G2S

715001401

- Provides specific area to install license plate.
- Mounts to rear of vehicle.

APACHE TRACK SYSTEMS

Apache Track Systems

Apache Backcountry Track System	G2 (except 6x6 models), G2S, G2L	715005247
--	----------------------------------	------------------



- Designed to deliver the best flotation level and deep-snow performance on the market.
- Contact patch is 23% bigger than the Apache 360 LT.
- Impressive added ground clearance of 7" (18 cm), keeps the vehicle out of deep snow.
- Aggressive track design with 2" (5 cm) lug height for maximum traction on snow.
- Apache Backcountry Mounting Kit and engine and air intake pre-filters are required.
- For winter use only.

Idler Wheel Kit	Apache Backcountry Track System (rear tracks only)	860201230 · 141 mm
------------------------	--	---------------------------



- Reduces drag and rolling resistance.
- Includes 2 wheels, brackets and hardware.
- Add up to 2 kits per rear track.
- Can extend slider life in hardened snow conditions.

Sliders with Vespel⁺ Inserts	Apache Backcountry Track System	503194815
--	---------------------------------	------------------



- Use DuPont Vespel inserts for less friction.
- Longer life.
- Can be cut to desired length.
- 8 needed per vehicle.
- Sold individually.

Rail Ice Scratchers	Apache Backcountry Track System	860201728
----------------------------	---------------------------------	------------------



- Provide additional lubrication in hard and icy conditions.
- Rail mounted, small, light.
- Design expands on coil concept to allow reversing without damage.
- Easily stored when not in use.

Apache 360 & 360 LT

Apache 360 Track System	G2 (except 6x6 models), G2L, G2S	715006323
--------------------------------	----------------------------------	------------------



- Multifunctional tracks perfect for any Can-Am ATV.
- Average ground clearance of 16" (41 cm).
- 1" (2.5 cm) lugs in the front and 1.25" (3.2 cm) in the back.
- Apache 360 & 360 LT Mounting Kit and engine and air intake pre-filters are required.

Apache 360 LT Track System	G2, G2L, G2S	715005103
-----------------------------------	--------------	------------------



- Multifunctional tracks designed to support heavy loads and to fit on most Can-Am Off-Road vehicles.
- Front wheel height adjustment provides enhanced attack angle and better performance over rough terrain when raised or increased contact patch for improved flotation when lowered.
- Average ground clearance increase of 4.5" (11.4 cm).
- 1" (2.5 cm) lugs in the front and 1.25" (3.2 cm) in the back.
- Reliable heavy-duty build.
- EC compliant.
- Contact patch is 7 to 9% bigger than the Apache 360's.
- Apache 360 and 360 LT Mounting Kit, Track DPS Module and Engine and air intake pre-filters are required.

Apache 360 LT 6x6

Apache 360 LT (6x6) Track System

G2, G2L (6x6 only)

715005104



- Multifunctional tracks designed to support heavy loads and to fit on most Can-Am Off-Road vehicles.
- Front wheel height adjustment provides enhanced attack angle and better performance over rough terrain when raised or increased contact patch for improved flotation when lowered.
- Average ground clearance increase of 4.5" (11.4 cm).
- 1" (2.5 cm) lugs in the front and 1.25" (3.2 cm) in the back.
- Apache 360 LT Mounting Kit, Track DPS Module and Engine & Pre-Filter Kit are required.
- Reliable heavy-duty build.
- EC compliant.
- Exclusively for the Outlander 6x6.
- Recommended for use on snow only.

Apache Accessories

Apache Backcountry Mounting Kit

(Not illustrated)

G2 2018 & prior, G2S 2018 & prior, G2L

715004830

G2 2019, G2S 2019

715004796

- Required for installation of the Apache Backcountry Track System.
- DPS module and pre-filter are required and sold separately.

Track DPS Module

(Not illustrated)

G2, G2L, G2S

715007338

- An innovative DPS module that ensures speedometer accuracy and optimized steering assist, which make for perfect track control and riding ease.
- Required to install the Apache and Backcountry Track Systems.

Apache 360 & 360 LT Mounting Kit

(Not illustrated)

G2 2018 & prior (except 6x6 models) G2S 2018 & prior, G2L

715007207

G2 2019 & up (except 6x6 models), G2S 2019 & up

715007206

G2 2018 & prior, G2L (6x6 models)

715004991

G2 (6x6 models 2019 & up)

715005105

- Required to install Apache 360 & 360 LT Track Systems.
- DPS module and pre-filter not included.

Apache Track System Accessories

Air Intake Pre-Filter

715003483



- Adds extra protection to your engine in harsh riding conditions.
- Filter blocks particles larger than 0.007" (0.19 mm).
- Easy, tool-less installation.
- Necessary to maintain vehicle warranty when tracks are installed.
- Required to install the Apache and Backcountry Track Systems.
- Standard on Outlander 650, 650 X mr, 850, 1000, 1000R engines and G2L PRO.
- Not compatible with Snorkel Kits.

Engine Air Intake Pre-Filter

G2, G2L, G2S

715004729



- Adds extra protection to your engine in harsh riding conditions.
- Filter blocks particles larger than 0.005" (0.13 mm).
- Necessary to maintain vehicle warranty when tracks are installed.

APACHE TRACK SYSTEMS FITTING GUIDE

Apache Backcountry

Model Year / Model	Track	Track Mount	Track DPS Module	Prefilter without Snorkel	Prefilter with Snorkel
2015 & Up G2L	715005247	715004830	715007338	715004729 & 715003483 (standard on G2 models and G2L PRO model)	715004729
2018 & Prior G2, G2S					
2019 & Up G2, G2S		715004796			

Apache 360 and Apache 360 LT

Model Year / Model	Track	Track Mount	Track DPS Module	Prefilter without Snorkel	Prefilter with Snorkel
2015 & Up G2L	715006323 (Apache 360) OR 715005103 (Apache 360 LT)	715007207	715007338	715004729 & 715003483 (standard on G2 models and G2L PRO model)	715004729
2018 & Prior G2, G2S					
2019 & Up G2, G2S		715007206			

Apache 360 LT 6x6

Model Year / Model	Track	Track Mount	Track DPS Module	Prefilter without Snorkel	Prefilter with Snorkel
2018 & Prior G2 6x6	715005104	715004991	715007338	715004729 & 715003483 (standard on G2 models and G2L PRO model)	715004729
2019 & Up G2L 6x6					
2019 & Up G2 6x6		715005105			

PROMOUNT PLOWS

PROMOUNT PLOW KITS

Reference Chart

	54" Black Steel	54" Yellow Steel	60" Black Steel	60" Yellow Steel	66" Black Steel	66" Yellow Steel	60" Flex2
Plow Kit	715007753	715008178	715007754	715008179	715007755	715008180	715008181
Blade	715004472	715005316	715004202	715005317	715006337	715006338	715004203
Push Frame	715007752	715007752	715007752	715007752	715007752	715007752	715007752
Mounting Plate	715007751	715007751	715007751	715007751	715007751	715007751	715007751

Steel Plows

Can-Am ProMount Steel Plow Kits 54" (137 cm) Blade

G2, G2L, G2S

■ 715007753 · Black
■ 715008178 · Yellow



- These kits include:
 - Can-Am ProMount Steel Blade
 - Push Frame with Quick-Attach System
 - Mounting Plate

Can-Am ProMount Steel Plow Kits 60" (152 cm) Blade

G2, G2L, G2S

■ 715007754 · Black
■ 715008179 · Yellow



- These kits include:
 - Can-Am ProMount Steel Blade
 - Push Frame with Quick-Attach System
 - Mounting Plate

Can-Am ProMount Steel Plow Kits 66" (168 cm) Blade

G2, G2L, G2S

■ 715007755 · Black
■ 715008180 · Yellow



- These kits include:
 - Can-Am ProMount Steel Blade
 - Push Frame with Quick-Attach System
 - Mounting Plate

Can-Am ProMount Steel Blades 54" (137 cm) Blade

Fits ProMount Push Frame

■ 715004472 · Black
■ 715005316 · Yellow



- Blades available individually to create your own kit.
- Compatible with Can-Am ProMount Blade accessories to further enhance plow versatility (some plow accessories are not compatible with 54" (137 cm) plows).
- Not compatible with ProMount Drift Cutters, Blade Extensions and Edge Markers.
- Clears 50" (127 cm) when plow is fully angled.
- Blade height of 14.75" (37 cm).

**Can-Am ProMount Steel Blades
60" (152 cm) Blade**

Fits ProMount Push Frame

■ **715004202** · Black
■ **715005317** · Yellow



- Blades available individually to create your own kit.
- Compatible with Can-Am ProMount Blade accessories to further enhance plow versatility.
- Clears 54" (137 cm) when plow is fully angled.
- Blade height of 17" (43 cm).

**Can-Am ProMount Steel Blades
66" (168 cm) Blade**

Fits ProMount Push Frame

■ **715006337** · Black
■ **715006338** · Yellow



- Blades available individually to create your own kit.
- Compatible with Can-Am ProMount Blade accessories to further enhance plow versatility.
- Clears 60" (152 cm) when plow is fully angled.
- Blade height of 17" (43 cm).

**Can-Am ProMount Steel Blades
72" (183 cm) Blade**

Fits ProMount Push Frame

■ **715004474** · Black
■ **715006021** · Yellow



- Blades available individually to create your own kit.
- Compatible with Can-Am ProMount Blade accessories to further enhance plow versatility.
- Clears 66" (168 cm) when plow is fully angled.
- Blade height of 17" (43 cm).

Can-Am ProMount Flex2 Plow Kit

Can-Am ProMount Flex2 – 60" (152 cm) Plow Kit

G2, G2L, G2S

715008181



- These kits include:
 - Can-Am ProMount Flex2 Blade
 - Push Frame with Quick-Attach System
 - Mounting Plate

**NEW Can-Am ProMount Flex2 – 66" (168 cm)
Plow Kit**

G2, G2L, G2S

■ **715008182** · Black



- This kit includes:
 - Can-Am ProMount Flex2 blade
 - Push Frame with Quick-Attach System
 - Mounting plate

Angle Plows

Can-Am ProMount Angle Blades 60" (152 cm) Steel Oneway State Blade

G2, G2L, G2S

715007261



- Make the job easier with the right tools, clear long alleys and make the task easier by sending the snow further out of the way.
- Wing end of plow measures 25" (63 cm) high and tapers down to 17" (43 cm).
- One-way "winged" state plow designed to throw snow higher.
- Rubber flap (715007299) designed to keep snow away from the driver is offered as accessory (sold separately).
- Can-Am branded.

Can-Am ProMount Angle Blades 66" (168 cm) Steel Oneway State Blade

G2, G2L, G2S

715007263



- Make the job easier with the right tools, clear long alleys and make the task easier by sending the snow further out of the way.
- Wing end of plow measures 25" (63 cm) high and tapers down to 17" (43 cm).
- One-way "winged" state plow designed to throw snow higher.
- Rubber flap (715007299) designed to keep snow away from the driver is offered as accessory (sold separately).
- Can-Am branded.

Can-Am ProMount Angle Blades 72" (183 cm) Steel Oneway State Blade

G2, G2L, G2S

715007264



- Make the job easier with the right tools, clear long alleys and make the task easier by sending the snow further out of the way.
- Wing end of plow measures 25" (63 cm) high and tapers down to 17" (43 cm).
- One-way "winged" state plow designed to throw snow higher.
- Rubber flap (715007299) designed to keep snow away from the driver is offered as accessory (sold separately).
- Can-Am branded.

ProMount One-Way State Blade Rubber Flap (Not illustrated)

715007299

- Allows for more efficient snow projections in various snow conditions.

Can-Am ProMount Flex2 Plows

Can-Am ProMount Flex2 Blades – 60" (152 cm) Blade

Fits ProMount Push Frame

715004203



- Plow blade made of UHMWPE, flexible and impact absorbing material prevents damaging your plow when accidental impacts occur.
- Replaceable wear blade.
- Large pin designed for easy blade rotation to eliminate snow buildup at pivot point.
- Blade design provides best snow roll-off at any angle.
- Compatible with Can-Am ProMount Blade accessories to further enhance plow versatility.
- Clears 54" (137 cm) when plow is fully angled.

NEW Can-Am ProMount Flex2 66" (168 cm) Blade

Fits ProMount Push Frame

715006265



- Plow blade made of UHMWPE, flexible and impact absorbing material prevents damaging your plow when accidental impact occurs.
- Replaceable wear blade.
- Large pin designed for easy blade rotation to eliminate snow buildup at pivot point.
- Blade design provides best snow roll-off at any angle.
- Clears 60" (152 cm) when plow is fully angled.
- Blade height of 17" (43 cm).
- Compatible with Can-Am ProMount Blade accessories to further enhance plow versatility."

Can-Am ProMount Flex2 Blades – 72" (183 cm) Blade

Fits ProMount Push Frame

715004485



- Plow blade made of UHMWPE, flexible and impact absorbing material prevents damaging your plow when accidental impacts occur.
- Replaceable wear blade.
- Large pin designed for easy blade rotation to eliminate snow buildup at pivot point.
- Blade design provides best snow roll-off at any angle.
- Compatible with Can-Am ProMount Blade accessories to further enhance plow versatility.
- Clears 66" (168 cm) when plow is fully angled.

Can-Am ProMount Plow Accessories

Can-Am ProMount Push Frame with Quick-Attach System

G2, G2L, G2S

715007752



- Heavy-duty steel tubes designed to withstand the roughest use.
- Mid-mount carriage provides ultimate push strength and traction.
- Designed for maximum plow lift height.
- Features a self-aligning quick-attach system, an easy foot release pedal and an ergonomic handle for plow angle adjustment.
- Plow Roller Fairlead and Plow Limit Switch recommended to extend winch cable lifespan.
- Can-Am ProMount Mounting Plate required for installation.
- Blade swivels left or right, 5 positions.
- Large pin designed for easy blade rotation to eliminate dirt and snow buildup at pivot point.

Can-Am ProMount Mounting Plate

G2, G2L, G2S

715007751



- Required to install the Can-Am ProMount Push Frame with Quick-Attach System.
- Mounting plate precision-designed to stay on year round without compromising ground clearance.
- Fits on ATVs with or without Can-Am Skid Plates.
- Plow Roller Fairlead included.

Can-Am ProMount Push Frame Extension

G2, G2L, G2S

715006257



- 12" (30 cm) push frame extension.
- Required when plow is installed with Apache Track System.

Can-Am ProMount Edge Markers

G2, G2L, G2S

715004206



- Help locate the edges of your plow.
- Height: 24" (60 cm).
- Sold in pairs.
- Compatible with Can-Am ProMount Steel and Flex2 Blades with or without Blade Extensions (except for the Can-Am ProMount Steel 54" (137 cm) Blades).

Can-Am ProMount Drift Cutters

G2, G2L, G2S

715006258



- Help keep snow in the plow.
- Dimensions: 17" x 13" (43.2 cm x 33 cm).
- Sold in pairs.
- Compatible with Can-Am ProMount Steel and Flex2 Blades with or without Blade Extensions (except for the Can-Am ProMount Steel 54" (137 cm) Blades).

Can-Am ProMount Curved Wear Blade

G2, G2L, G2S

715007791 · 60" (152 cm)

715007792 · 66" (168 cm)



- Wear blade designed with a folded back bottom lip.
- The increased surface allows for less digging while plowing uneven surfaces.
- Ideal for snow covered gravel, grass, paver stone and other soft surfaces.

Can-Am ProMount Plastic Wear Blade

G2, G2L, G2S

715004480 · 54" (137 cm)

715004481 · 60" (152 cm)

715004482 · 66" (168 cm)

715004483 · 72" (183 cm)



- To help prevent scratches on smooth driveways and markable surfaces.

Can-Am ProMount Blade Extensions

G2, G2L, G2S

■ 715004205 · Black
■ 715005319 · Yellow



- Add 3" (8 cm) each side.
- Compatible with Can-Am ProMount Blades (except for Can-Am ProMount Steel 54" (137 cm) Blade).
- Longer Wear Blade can be installed to further extend the extra length already provided by the extensions.
- Compatible with Can-Am ProMount Steel and Flex2 Blades (except for the Can-Am ProMount Steel 54" (137 cm) Blades).

Back Drag Blade

ProMount Plows (60" and more)

715007794



- ¼ thick steel swivel scraper.
- Lifts up when the vehicle is moving forward so as not to affect the scraping.
- Increased capacity to pull snow.
- More aggressive scraping in reverse mode.
- Lifts the blade off the ground so that it scrapes evenly.
- Adjustable in length for compatibility with 60", 66" and 72" blades.
- Compatible with ProMount blades (Flex and Steel).

Plow Roller Fairlead

G2, G2L, G2S

705009222



- Larger diameter lower roller reduces wear on wire rope for plow application.
- Can be used with all ProMount plows.
- Included in plow mounting plate kit (715007751).

Pulley Kit for Alpine Super-Duty Plow

G2, G2L

715000279



- Pulley kit to be used in conjunction with the winch when using a snow plow.
- Recommended to increase winch efficiency.
- To be used with the XT Front Bumper.

Synthetic Winch Cable for Plowing

715000540



- Specially designed for plowing applications.
- 8' (2.4 m) section of durable, extra-strong synthetic rope.
- Stands up to repeated, sharp angle pulls used to lift heavy plow blades.
- Temporarily replace your winch rope for plow season to save wear and tear on wire rope.

Plow Limit Switch

(Not illustrated)

G2, G2L, G2S

715006259

- For controlling the cable tension when over raising your plow system.
- Prevents winch, plow push frame and vehicle damage.

Can-Am ProMount Plow Angling System

G2, G2L, G2S







715007801



- Converts your plow system into an easy-to-control unit from the driver's seat.
- Using one hand to control all plow motions will allow you to easily concentrate and manage your plowing tasks.
- Compatible with ProMount Blade.
- Push Frame (715007752) is required.
- Push Frame Extension (715006257) is required for installation with the Front Rancher Bumper.
- Winch and plow sold separately.

TYRES & RIMS

Tyres

Carlisle ACT Tyre	G2 (500-1000 XT models only)	705401333 · Front 705401334 · (€) <hr/> 705501769 · Rear 705501770 · (€)
	<ul style="list-style-type: none"> • Front - 26" x 8" x 12". • Rear - 26" x 10" x 12". 	
Carlisle ACT Tyre	G2 (400 XT models only)	705400606 · Front 705400326 · (€) <hr/> 705500598 · Rear (€)
	<ul style="list-style-type: none"> • Front - 25" x 8" x 12". • Rear - 25" x 11" x 12". 	
Carlisle ACT HD Tyre	705402562 · Front 705502940 · Rear	
	<ul style="list-style-type: none"> • Front - 26" x 8" x 12". • Rear - 26" x 10" x 12". 	
Carlisle Badlands A/R Tyre	G2 (500-1000 Base models only)	705401331 · Front 705401332 · (€) <hr/> 705501767 · Rear 705501768 · (€)
	<ul style="list-style-type: none"> • Front - 26" x 8" x 12". • Rear - 26" x 10" x 12". 	
Carlisle Trail Wolf Tyre	G2 (400 Base models only) G2L (450/570)	705402890 · Front 705400607 · (€) <hr/> 705503225 · Rear 705502165 · (€)
	<ul style="list-style-type: none"> • Front - 25" x 8" x 12". • Rear - 25" x 11" x 12". 	
ITP TerraCross Tyre	G2 XTP, G2 Limited	705402973 · Front 705502858 · Rear
	<ul style="list-style-type: none"> • This smooth-riding tyre will command every bit of traction from the ground while still managing to float across loose snow, sand and mud. • Features extreme-duty construction for improved puncture protection and extra-tough rubber compound for increased tread life. The interlocking tread pattern and wide footprint make it one of the toughest and grippiest radials around. • Not EC compliant. • Front - 26" x 8" x 14". • Rear - 26" x 10" x 14". 	

		705400600 · Front 705400475 · C € <hr/> 705500926 · Rear 705500820 · C €
--	--	---

ITP Holeshot ATR Tyre

G2S



- Front - 205/80R12 - 25" x 8" x 12".
- Rear - 270/60R12 - 25" x 10" x 12".

	G2 X mr 570 & 650 2018 & up G2S X mr 570 2018 & up	705402131 · Front 705502645 · Rear
--	--	---

ITP Mega Mayhem



- 1.5" tread depth mud thrower tyres.
- Surprisingly smooth ride on hard pack surfaces.
- 6-ply rated.
- Front - 28" x 9" x 12".
- Rear - 28" x 11" x 12".

	G2 X mr 850 & 1000R 2018 & up G2S X mr 1000R 2018 & up	705402671
--	--	------------------

ITP Cryptid Tyre



- Graduated lug height and paddle-like shoulder configuration provide maximum side bite for climbing in and out of the mud without compromising ride comfort on trails and hard pack.
- 6-ply rated.
- 30" x 9" x 14".

	G2 (850 & 1000 models only)	705401501
--	-----------------------------	------------------

Gorilla Silverback Tyre



- AT30X9-14 Gorilla Silverback mud tyre.
- Sold individually.
- Not EC compliant.
- 30" x 9" x 14".

	G2 (X mr 570 & 650 models only)	705501836 · Rear
--	---------------------------------	-------------------------

Maxxis Mudzilla Tyre



- Not EC compliant.
- Rear - 28" x 10" x 12".

	DS 90 X	V42711DGF01HLL · Front V42712DGF01HLL · Rear
--	---------	---

Kenda Klaw MXR Tyre



- Front - 20" x 6" x 10".
- Rear - 18" x 10.5" x 8".

Rims

14" Rim



- Premium cast aluminum black painted with machining and clear coat rim.
- Center hole: 72 mm.
- Bolt circle pattern: $\frac{4}{16}$ mm.

705401853 · Front
705401852 · Front
705401851 · Front
705502402 · Rear
705502401 · Rear
705502400 · Rear

■ Black and machined
■ Black with clear coat
■ Silver with clear coat
■ Black and machined
■ Black with clear coat
■ Silver with clear coat

- Front - 14" x 6.5" offset = 40 mm.
- Rear - 14" x 8.5" offset = 50 mm.

Note: Matching Nuts - 250100100 Black, 250100082 Chrome/Matching Cap - 705400928

14" Rim



- Front - 14" x 6.5" offset = 40 mm.
- Rear - 14" x 8.5" offset = 50 mm.

G2 DPS, G2 XT, G2 MAX Limited, G2 North Edition, G2 MAX North Edition

705402309 · Front
705402222 · Front
705402307 · Front
705502770 · Rear
705502702 · Rear
705502768 · Rear

■ Black and machined
■ Black with clear coat
■ Silver with clear coat
■ Black and machined
■ Black with clear coat
■ Silver with clear coat

Outlander X mr and Defender Rim



- Cast aluminum rim with trend setting explosive styling so you can ride—and look—like a trailblazer.
- Front - 14" x 6.5" offset = 10 mm.

Note: Matching Nuts - 250100100 Black, 250100082 Chrome/Matching Cap - 705401541

X mr models front and rear wheels

705401848 · Front
705401849 · Front

■ Black and machined
■ Black

Outlander Rim (Camo Model)



- Black with clear coat aluminum rim.
- Front - 12" x 6" offset = 41 mm.
- Rear - 12" x 7.5" offset = 51 mm.

G2, G2L, G2S

705401127 · Front
705501493 · Rear

■ Black with clear coat
■ Black with clear coat

12" Beadlock Rim



- Black with clear coat aluminum rim.
- Needs 16 bolts (250000787) for installing the beadlock.
- Choice of beadlock colour (not included).
- Front - 12" x 6" offset = 41 mm.
- Rear - 12" x 7.5" offset = 51 mm.

G2, G2L, G2S

705401678 · Front
705502244 · Rear

■ Black
■ Black

12" Beadlock Ring



- Cast aluminum beadlock.
- Must be installed on Front Rim (705401678) and Rear Rim (705502244).

Note: Matching Nuts - 250100184 Black, 250100185 Chrome/Matching Cap - 705400928

G2, G2L, G2S

705401763 · ■ Can-Am Red
705401810 · ■ Yellow

705401811 · ■ Orange Crush
705401812 · ■ Manta Green

14" Beadlock Rim

G2

705401594 · Front

■ Black

705503191 · Rear

■ Black



- Black with clear coat aluminum rim.
- Choice of beadlock colour (not included).
- Needs 16 bolts (250000787) for installing the beadlock.
- Front - 14" x 6.5" offset = 41 mm.
- Rear - 14" x 8" offset = 51 mm.

14" Beadlock Ring

G2

705401586 · ■ Manta Green

705401837 · ■ Can-Am Red

705401702 · ■ Octane Blue

705401840 · ■ Black



- Cast aluminum beadlock.
- Must be installed on Front Rim (705401594) and Rear Rim (705503191).

Note: Matching Nuts - 250100184 Black, 250100185 Chrome/Matching Cap - 705400928



PARTS AND MAINTENANCE

PARTS AND MAINTENANCE

Genuine Parts	223
Lubricant & Oil Change Kit	228
Maintenance Products	229
Care Products	231



GENUINE PARTS

Oil Filters

Oil Filters	Models	Oil Filter	Sealing Ring (Oil Filter Cover)	Sealing Ring (Drain Plug)
	Defender/Defender MAX HD10, HD9	420256188	420230923	420552280
	Defender/Defender MAX HD7	420256188	420230922	420552280
	Maverick X3	420956123	420230923	420552280
	Maverick Trail & Sport	420256188	420230923	420552280
	G2S, G2 & G2L	420256188	420230923	420552280
	Commander	420256188	420230922	420552280

Complete Engine Oil Change Kit also available — see page 228

Air Filters

Premium Air Filter

- Premium quality filter.
- Prevents airborne contaminants from reaching your engine.
- Protects internal components against premature wear.

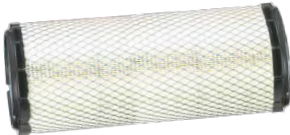
	Models	
	Defender/Defender MAX	715900394
	Maverick X3	715900422
	Maverick Trail & Sport (Engines 700 & 1000)	715900394
	Maverick Trail & Sport (Engine 1000R)	715900422
	G2S, G2 & G2L	707800371
	Commander (Engines 700 & 1000R)	715900394
Commander (Engine 1000R)	715900422	

Performance Air Filter by Twin Air†

- The best choice for the harshest conditions.
- Multiple staged oiled filtering foam for superior dust retaining capacity with high air flow.
- Washable and reusable.

	Models	
	Maverick X3	715002895
	Maverick Trail & Sport	715002895
	G2S, G2 & G2L	715001333
	Commander	715001956

CVT Air Filter (Not illustrated)

Models	
Defender/Defender MAX (except X mr)	706600419
Maverick X3	706600416
Maverick Trail & Sport (except X mr)	706600417
Maverick Trail & Sport X mr	706600418
G2, G2L	715003483
G2S	707001786
Commander (2018 & Up)	706600417

Spark Plug

Spark Plug	Models	
	Defender HD10	715900244
	Defender HD9	715900642
	Defender HD7	715900785
	Maverick X3 and Maverick X3 Turbo RR	415130363
	Maverick Trail & Sport 1000R	715900244
	Maverick Trail & Sport 1000	715900642
	Maverick Trail 700	715900785
	ATV 450/850/1000R	715900352
	ATV 570/650/1000	715900642
	Commander 700	715900785
Commander 1000R	715900244	

Batteries

Yuasa[†] Batteries

• Top of the line models from the leading preferred original equipment battery supplier in North America.



Models	3 A Wet (YTX4L-BS)	10 A Wet (YTX12-BS)	18 A Wet (YTX20L-BS)	30 A, requires Battery Holder (715004431)
Defender/Defender MAX	—	—	296000444	515176151 Except Base and DPS models.
Maverick X3	—	—	296000444	—
Maverick Trail & Sport	—	—	296000444	—
G2S, G2 & G2L	—	—	296000444	—
DS 50, 70 & 90	V31500MAA020	—	—	—
Renegade 70,110	V31500MAA020	—	—	—
DS 250	—	715900031	—	—
Commander	—	—	296000444	—

Axles

Premium CV Axle

- Premium quality design ideal for off-roading, heavy-duty and low speed torque usage.
- Includes CVs, shaft and boots with the best suited geometry for your Can-Am vehicle.



Models	Front Left	Front Right	Rear
Defender MAX	705401937	705401936	705502451
Defender XT-P	705402353	705402353	705502451
Defender HD10	705401937	705401936	705502451
Defender HD9	705401937	705401936	705502451
Defender HD7	705401937	705401936	705502478 (L) 705502479 (R)
Maverick Sport (ABS)	705402443	705402443	705502756
Maverick Sport Base, DPS	705402031	705402030	705502552
Maverick Trail (W/O ABS)	705402008	705402007	705502541
Maverick Trail (ABS)	705402442	705402442	705502755
Commander	705401871	705401872	705502411

All ATVs: Please contact your dealer or visit our online store at can-amoffroad.com for suggested fitment.

Performance CV Axle

(Not illustrated)

- High-performance design ideal for off-road use with superior wheel power and acceleration for racing, dunes, trails and desert riding.
- Includes CVs, shaft and boots with the best suited geometry for your Can-Am vehicle.

Models	Front Left	Front Right	Rear
Defender X mr	705402420	705402420	—
Maverick Sport X mr/X rc	705402282	705402282	705502757

Brakes

Metallic Brake Pad Kit

- Built strong to last long – heavy-duty construction stands up to hard braking.
- Designed to handle demanding riding conditions with challenging braking environments such as mud and dunes.
- Created specifically for use with Can-Am vehicles.



Models	Front Left	Front Right	Rear Left	Rear Right
Defender MAX HD9/HD10	715900379	715900380	715900386	715900387
Defender HD10	715900379	715900380	715900381	715900382
Defender HD9	715900379	715900380	715900381	715900382
Defender HD7	715900379	715900380	—	715900387
Maverick X3	715900379	715900380	715900386	715900387
Maverick Trail & Sport	715900379	715900380	715900386	715900387
G2S, G2 & G2L	715900248	715900249	715900248	715900249
Commander	715900379	715900380	715900386	715900387

Please contact your dealer or visit our online store at Can-Amoffroad.com for suggested fitment.

Parts

A-Arm Bushing Kit

703500875

- This bushing kit includes 2 bushings, a sleeve and a wear plate, as illustrated.
- All you need to renew your suspension A-Arms.



Ball Joints

- Robust design for off-road usage and sealed for prolonged durability.



Upper

706202044

Upper (Maverick X3, Trail & Sport, Commander)

706203084

Lower

706202045

Wheel Bearings

(Not illustrated)

2020 models and prior

293350118

2021 & up models

293350126

Maverick X3

293350141

- Sealed bearings for additional protection from water and dirt.

CV Boot Kit

- Comes with clamps and grease.
- Genuine BRP CV Boot Kits ensure absolute compatibility and a perfect fit.



Models	Front Wheel Side	Front Differential Side	Rear Wheel & Differential Side
Defender	705401345	705401355	705501864
Maverick X3	705401354	705401354	715900450
Maverick Sport (ABS, X xc, X mr, X rc)	705401354	705401355	705501864
Maverick Sport (w/o ABS), Maverick Trail	705401345	705401355	705501864
G2, G2L, G2S (except X mr)	705401345	705401346	705501864
X mr	705401354	705401355	705501864
Commander	705401345	705401355	705501864

Belts

BRP Premium Drive Belt

- High-performance design ideal for off-road use.
- BRP-specific calibration adjusted to best suit your Can-Am vehicle.



Models	Premium Belt	CVT Gasket Cover	Upgrades
Defender HD10	422280652	420450400	—
Defender HD9	422280656	420450400	422280652
Defender HD7	422280225	—	—
Maverick X3	422280652	420450405	—
Maverick Trail & Maverick Sport 1000	422280656	420450400	422280652
Maverick Trail 700	422280225	—	—
G2, G2S 450 CC & less	422280283	420430126	—
G2, G2S 500 CC & more	422280366	420430126	—
G2L Outlander 450 & Outlander MAX 450	422280283	420630292	—
Commander 2020 & prior	422280366	420450126	—
Commander 2021 & Up 1000 CC	422280656	420450400	422280652
Commander 700	422280225	—	—

Driven Pulley Adapter Tool

(Not illustrated)

- Spreads the secondary clutch open for easy belt replacement.

Puller/Locking Tool

(Not illustrated)

- Allows you to spread the secondary clutch open for easy belt replacement.

Models	Driven Pulley Adapter	Puller/Locking Tool
Defender HD10-HD9	708200720	529000088
Defender HD7	—	529036098
Maverick Trail & Sport	708200720	529000088
Maverick X3	708200720	529000088
G2, G2S	—	529036098
G2L Outlander 450 & Outlander MAX 450	—	529036098
Commander	—	529036352

pDrive Pulley Service kits

Ramp Roller Maintenance Set

SSV pDrive (MY22)

420629231

SSV pDrive (MY23)

Coming winter 2023

pDrive Ramp Roller Set

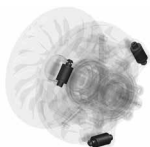

Torque Roller Maintenance Set

SSV pDrive (MY22)

420629224

SSV pDrive (MY23)

Coming winter 2023

pDrive Torque Roller Set

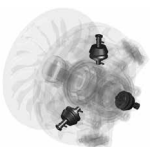

LUBRICANT & OIL CHANGE KIT

Lubricant

XPS 4T 10W-50 Synthetic Oil

9779234 · 1 qt / 946 ml

9779235 · 1 US gal / 3.785 L



- Engineered for heavy-duty and high-performance 4-stroke engines, including turbocharged, supercharged and racing engines.
- Formulated using carefully selected and strenuously tested base stocks and custom additives.
- Offers thick film strength to protect bearings, and a proven high-temp detergency to minimize deposits, prevent shear, provide thermal stability, and combat fuel dilution to ensure maximum performance from your engine.

XPS 4T 0W-40 Synthetic Oil

9779139 · 1 qt / 946 ml

9779140 · 1 US gal / 3.785 L



- Powersport formula with premium anti-wear and anti-corrosion additives.
- The best choice for high-performance snowmobile, ATV and SXS 4-stroke engines used in cold weather.
- Provides superior engine and transmission protection against heat, rust and corrosion.
- Delivers optimal performance in high and low temperatures.

XPS 4T 5W-40 Synthetic Blend Oil

9779133 · 1 qt / 946 ml

9779134 · 1 US gal / 3.785 L



- Off-road formula with premium anti-wear and anti-corrosion additives.
- Designed for high-performance off-road, on-road and PWC 4-stroke engines, including turbo or supercharged powersports engines.
- Provides superior engine and transmission protection against rust and corrosion, even in extreme conditions.

Oil Change Kit

Engine Oil Change Kit

Models



- Ultra-convenient "all-in-one" Engine Oil Change Kit saves time and money.
- Includes XPS Synthetic or Synthetic Blend Oil, oil filter, O-rings and washer.

5W-40 Synthetic Blend Oil / 450cc or less **9779256**

0W-40 Synthetic Oil / 450cc or less **9779257**

5W-40 Synthetic Blend Oil / 500 cc or more V-twin engine **9779258**

0W-40 Synthetic Oil / 500 cc or more V-twin engine **9779259**

10W-50 Synthetic Oil / 500 cc or more V-twin engine **9779252**

5W-40 Synthetic Blend Oil / 900 ACE **9779260**

10W-50 Synthetic Oil / 900 ACE **9779261**

MAINTENANCE PRODUCTS

Synthetic Gear Oil

75W-90
75W-140

9779158 · 1 qt / 946 ml
9779160 · 1 qt / 946 ml



- Uses custom additives to provide the best performance in Visco-Lok™ and Smart-Lok™ differentials.
- Allows higher loads, superior shear stability and reduced oxidation.
- Exceptional wear protection and superior performance at all operating temperatures.

Extended Life Pre-Mixed Coolant

9779150 · 1 qt / 946 ml



- Antifreeze/coolant contains the correct dilution and the necessary additives to prevent corrosion and inhibit cavitation in BRP cooling systems.
- Long-life, 5-year formula specially formulated for BRP vehicles.
- Superior heat transfer.
- Ideal replacement for vehicles that normally use a 2-year antifreeze/coolant (green).
- 5 years (orange).

Anti-Corrosive Lubricant

9779166 · US 12 oz / 340 g
9779167 · CDN 12 oz / 340 g



- Multipurpose lubricant that can also be used to prevent rust, corrosion and moisture intrusion.
- It contains extreme pressure additives that work as an all-around lubricant for just about anywhere lubrication is needed.

Extreme Duty Suspension Grease

(Not illustrated)

9779708 · 14 oz / 400 g

- Designed to work specifically with the components found in Can-Am vehicle suspensions.
- It is highly stable and offers optimal lubrication at both extreme cold and high temperatures while protecting suspension components from dirt and moisture, as well as corrosion under extreme washout conditions.

DOT 4 Brake Fluid

9779151 · 12 fl oz / 355 ml



- Meets or exceeds all DOT3 and DOT4 brake fluid requirements.
- High-temperature formula resists fade and also conditions seals and O-rings in braking system.

Racing Brake Fluid RS600

9779152 · 12 fl oz / 355 ml



- Exceeds DOT4 brake fluid requirements for extreme conditions and competition use.
- Extreme, 579-degree boiling point temperature is ideal for high-demand competition conditions to combat brake fade.
- Will not harm seals or braking system components.
- Should be added only to a clean/unfilled system to avoid dilution and diminished performance.
- Low-moisture formula slows water vapor absorption through multiple heat cycles.
- Recommended for use in Ski-Doo and Can-Am racing applications.

Fuel Stabilizer

9779171 · 8 fl oz / 236 ml



- Ethanol-compatible and will stabilize fuel in your tank to keep it from breaking down and causing hard starting, throttle hesitation and poor run quality.
- Since ethanol attracts moisture, this product contains powerful anti-corrosion additives to protect fuel system components.
- Prevents problems associated with E10 fuels.

CARE PRODUCTS

Cleaner and Degreaser, All Purpose

9779328 · 22 fl oz / 650 ml

9779329 · 2 qt / 1.89 L



- Ready-to-use formula.
- Cleans toughest dirt and grime.
- Phosphate free eco-friendly formula.
- Low-foam easy rinse formula.

Matte Finish Waterless Cleaner

9779330 · 22 fl oz / 650 ml



- Easy waterless use.
- Perfect for matte, flat and denim surfaces.
- Contains no wax or silicone.
- Leaves no unwanted streaks or marks.

Multi-Surface and Glass Cleaner

9779331 · 22 fl oz / 650 ml



- Easy waterless spray and wipe use.
- Polymer formula cleans and protects.
- Contains no wax or silicone.
- Leaves no unwanted streaks or marks.

Mud and Dust Off-Road Wash

9779340 · 33 fl oz / 946 ml

9779341 · 2 qt / 1.89 L



- Specially formulated for off-road vehicles, it breaks the bond holding grime and dirt to your vehicle's finish.
- The formula is biodegradable, eco-friendly with no phosphates or corrosive chemicals and is low foam for easy, quick rinsing.
- Effective on oil, grease and other stubborn grime.
- Safe for use on all surfaces.

Black Plastic and Rubber Restorer

9779335 · 7.6 fl oz / 225 ml



- Restores plastic, rubber and vinyl.
- Long-lasting formula.
- Protects against UV rays.

Foaming Wash

9779337 · 16 fl oz / 473 ml

9779338 · 2 qt / 1.89 L



- Concentrated formula for off-road vehicles, it produces a thick foam to lift dirt and prevent scratching.
- The pH neutral formula is safe for wax and paint sealants.
- Works in pressure washers or by hand.

Quick Detailer Gloss Enhancing

9779332 · 4 fl oz / 118 ml

9779333 · 16 fl oz / 473 ml



- Quick detail spray wax.
- Leaves a high gloss finish at every wipe.
- Nanotechnology polymer formula.
- Repels dirt.
- No water needed.

EVERY FARMER SHOULD OWN A CAN-AM

“
The Can-Am Defender makes your job easier on the farm.
The stability, suspension, handling, and power; there’s really no
comparison. Above all, it’s got all the features & technology to
make it safe for the whole family. Every farmer should own one.
”

Sir David Fagan

New Zealand Farmer.
16-time Record Winner Shearer.
Can-Am Owner.



EXPLORE AN ENTIRE WORLD OF ADVENTURE WITH ALL OF OUR BRP PRODUCTS. BRP.COM



ski-doo LYNX SEA-DOO can-am ROTAX ALUMACRAFT Manitow QUINTREX



can-am

CAN-AMOFFROAD.COM



MY23 830201329